

*PIERCE & PIERCE MILLWORK*

*FULL SCALE*

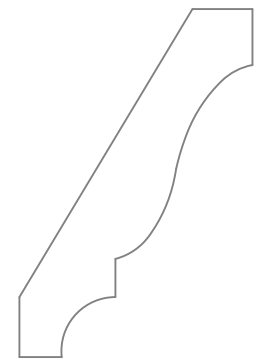

*PM-1007*

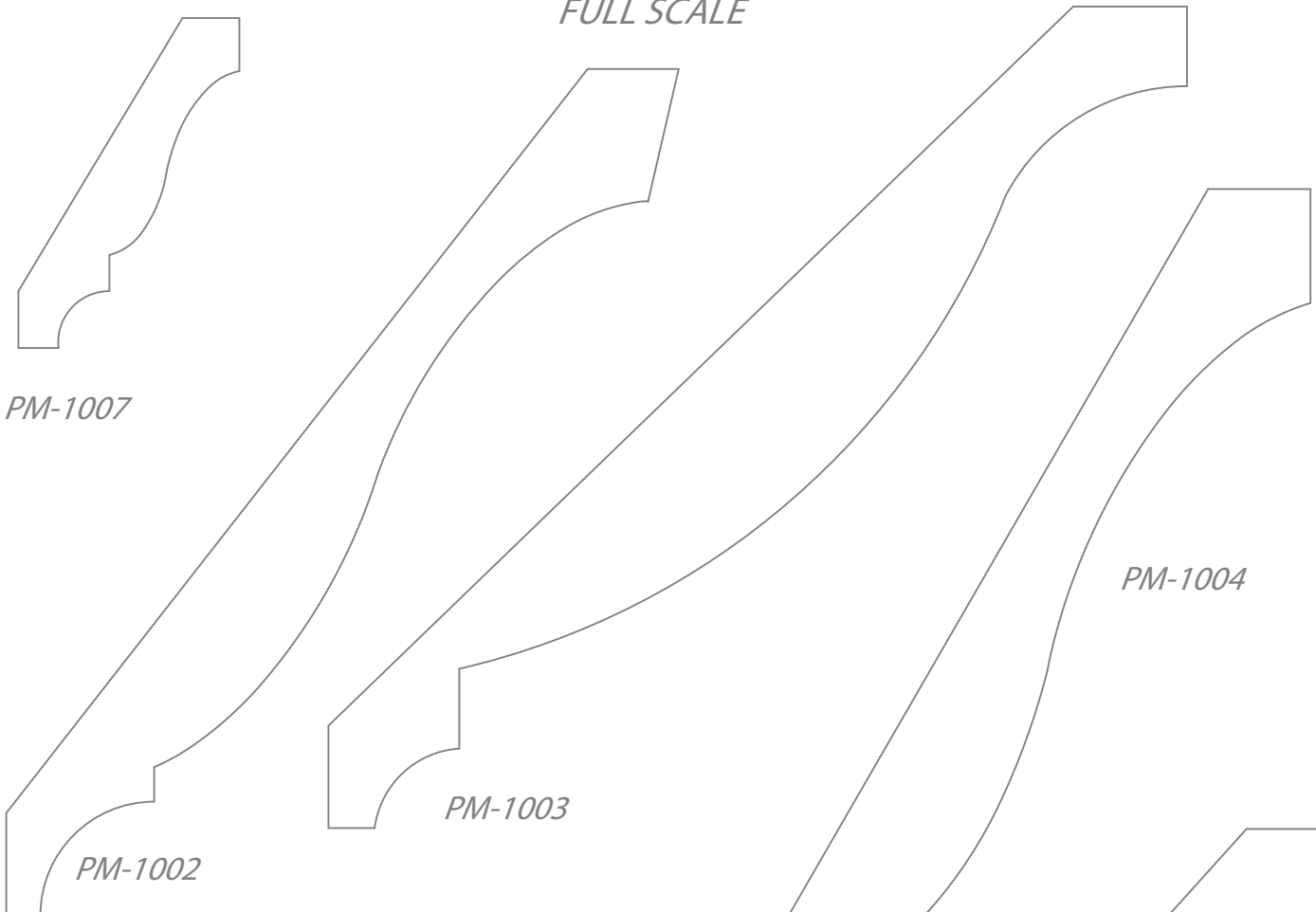

*PM-1002*



*PM-1003*

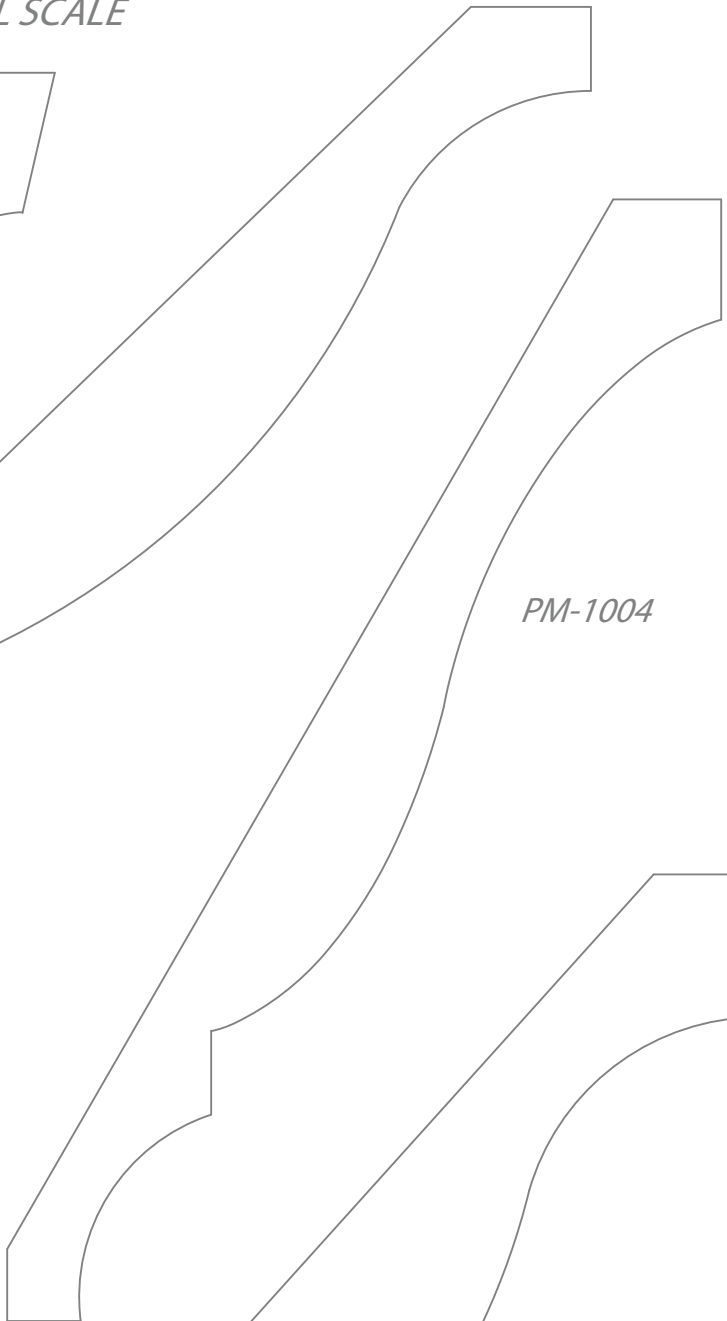

*PM-1004*

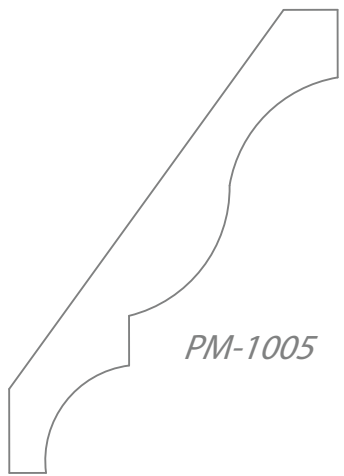

*PM-1005*

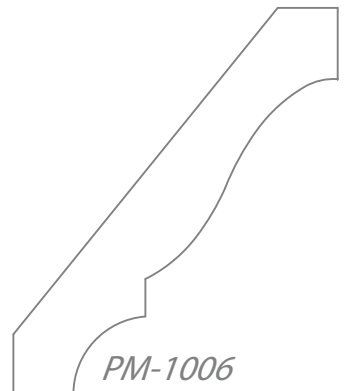

*PM-1006*

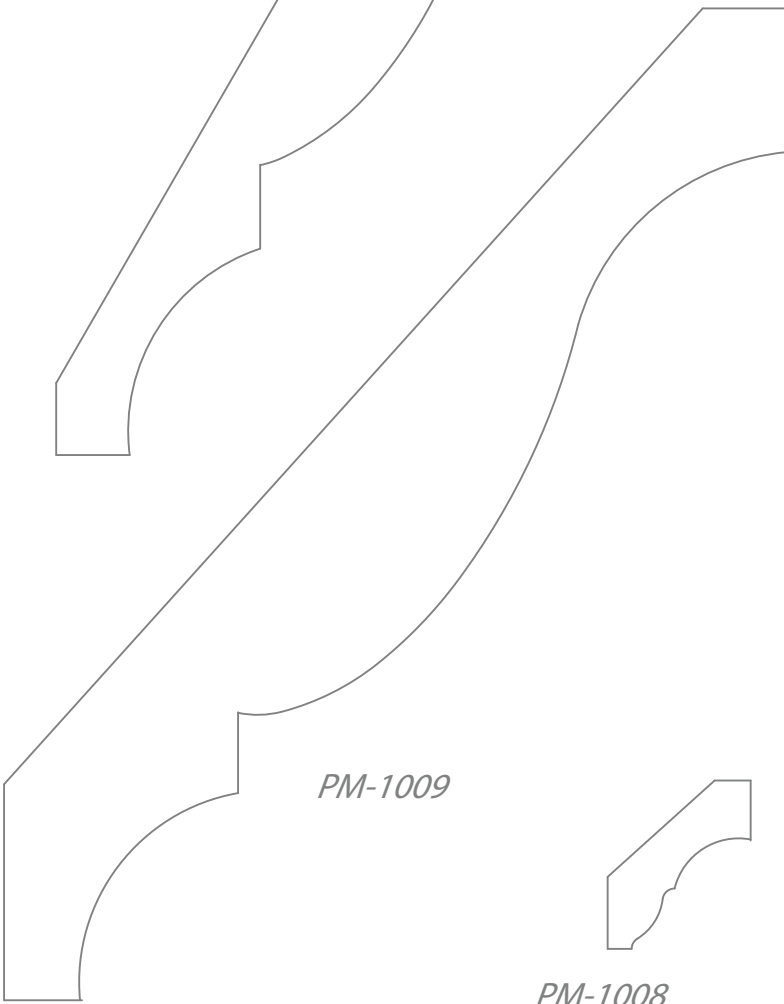

*PM-1009*

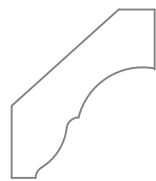

*PM-1008*

*PIERCE & PIERCE MILLWORK*

*FULL SCALE*

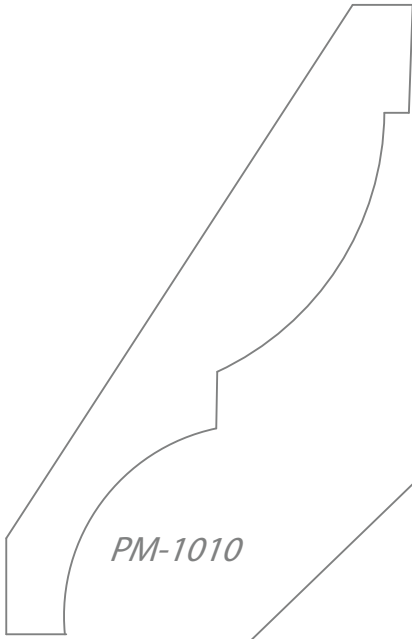

*PM-1010*

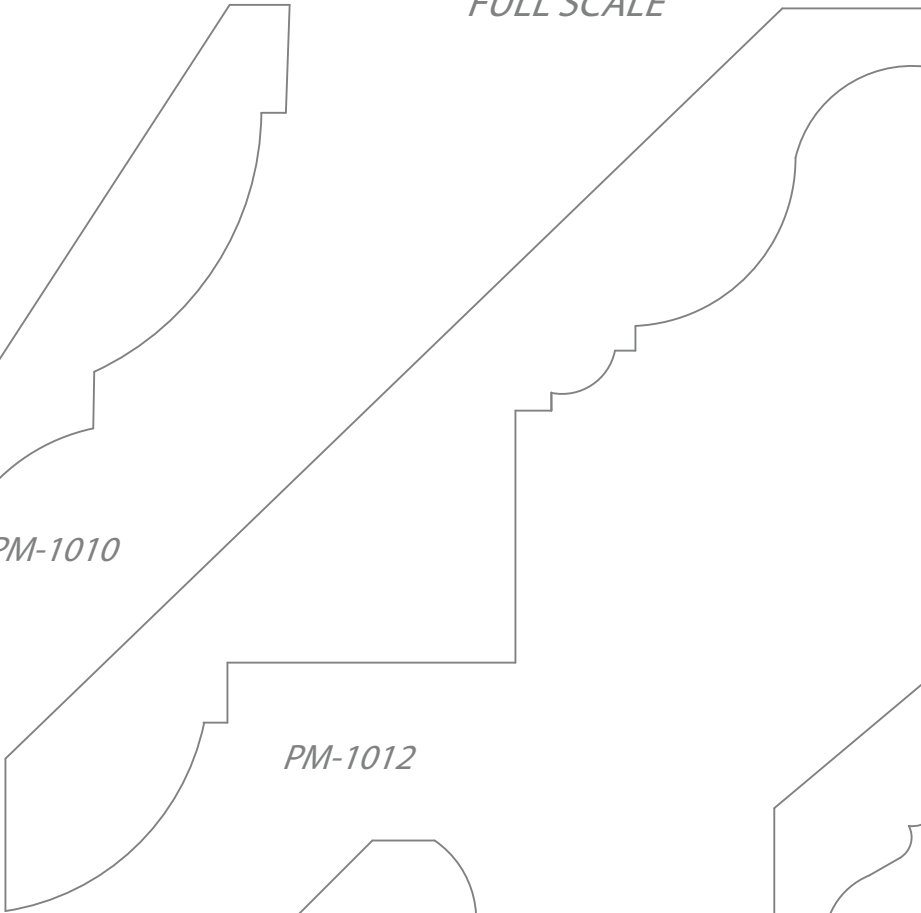

*PM-1012*

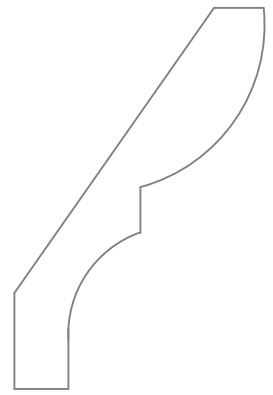

*PM-1011*

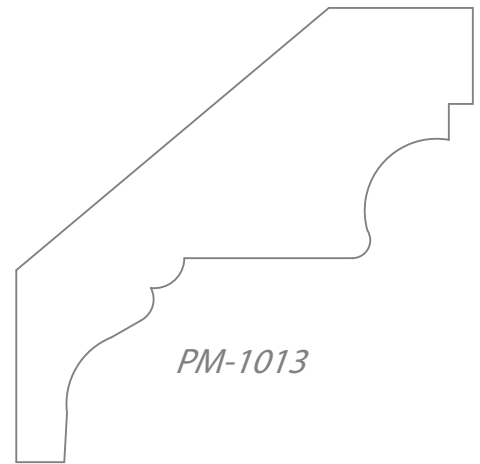

*PM-1013*

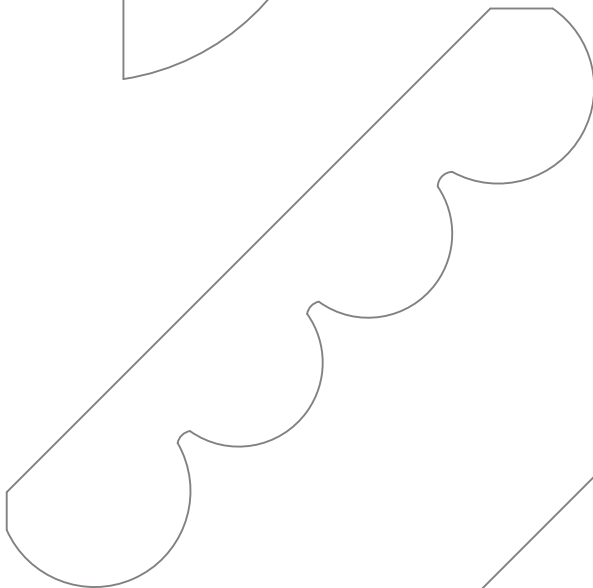

*PM-1014*

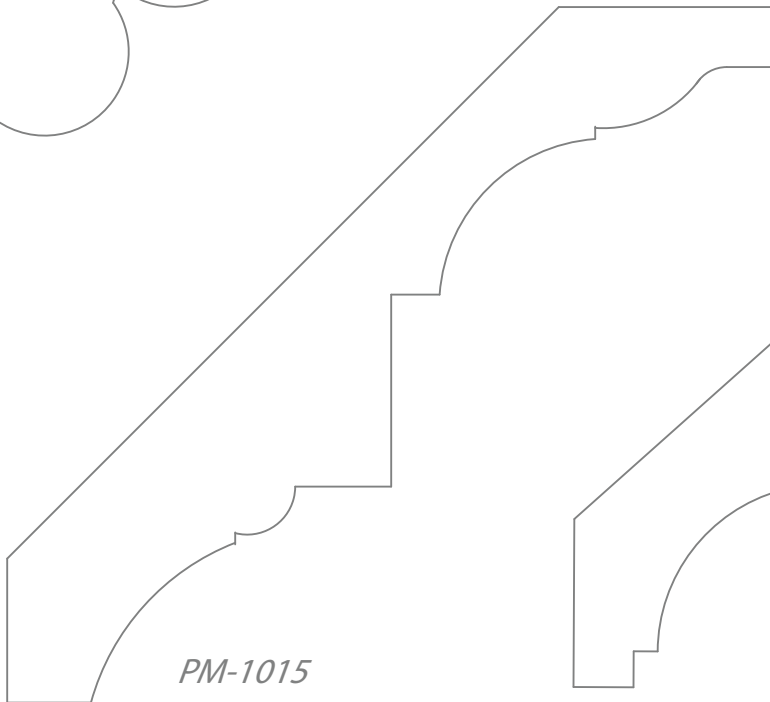

*PM-1015*

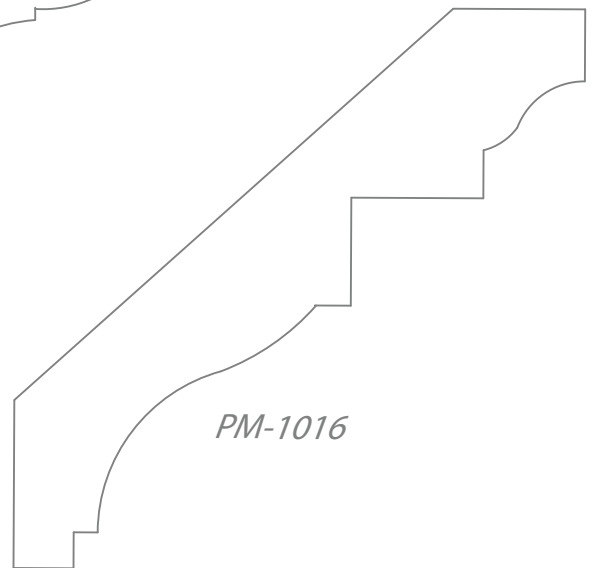

*PM-1016*

*PIERCE & PIERCE MILLWORK*

*FULL SCALE*

*PM-1019*

*PM-1020*

*PM-1017*

*PM-1018*

*PM-1021*

*PIERCE & PIERCE MILLWORK*

*FULL SCALE*

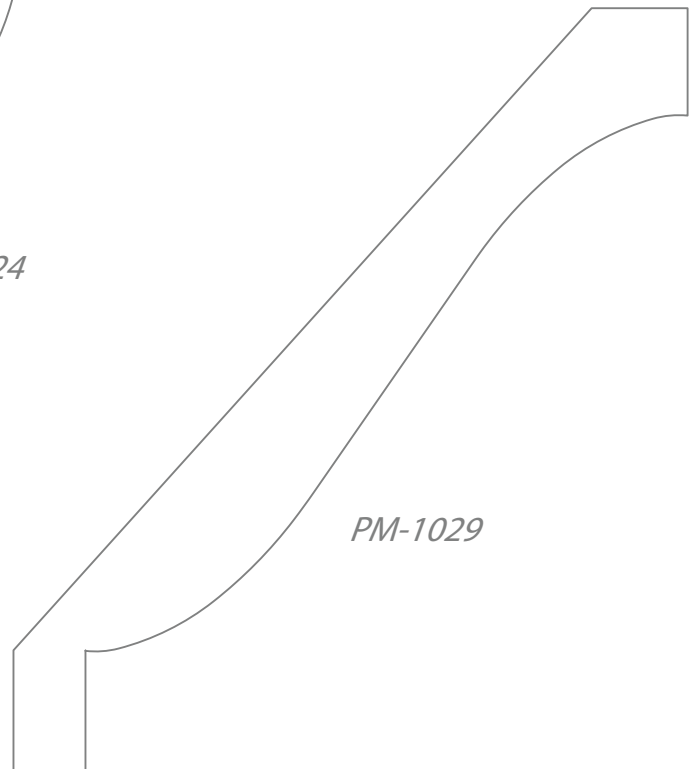
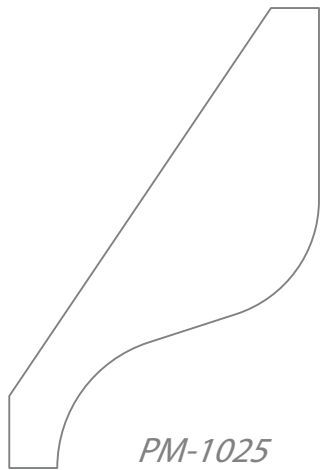
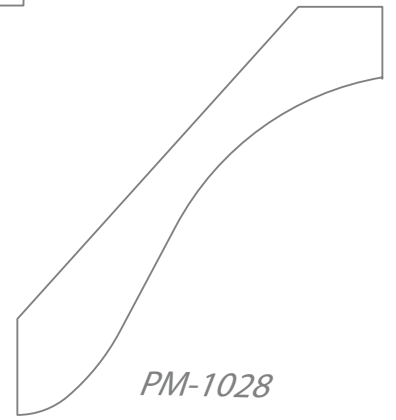
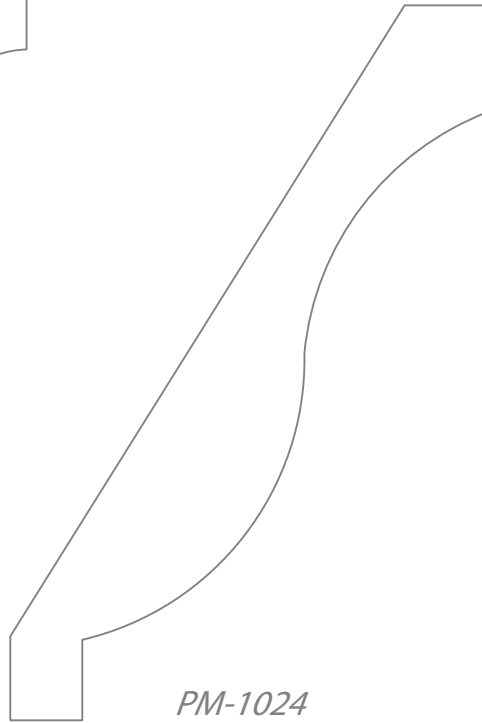
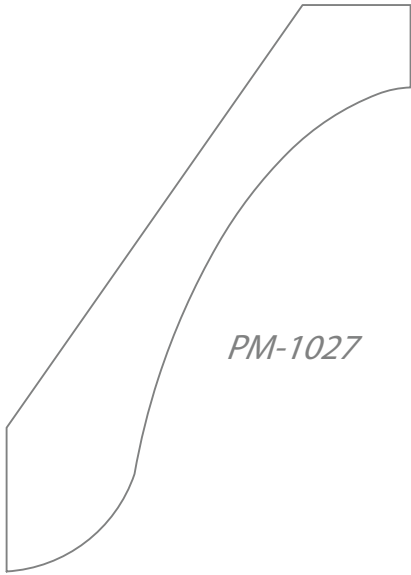
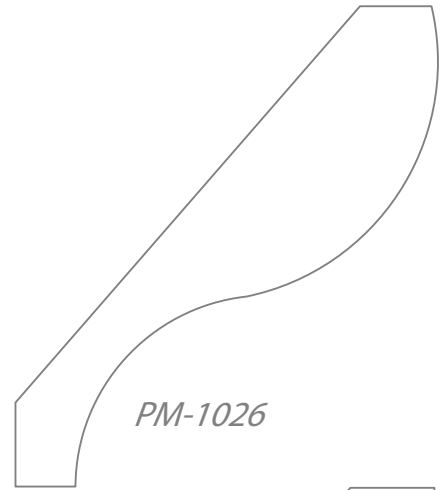
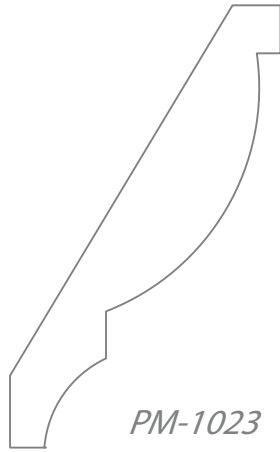
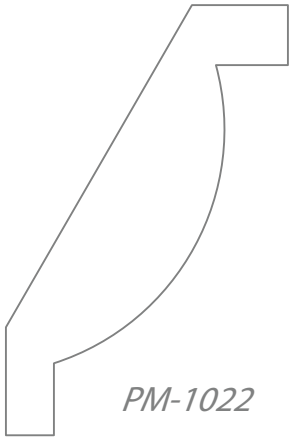

*PIERCE & PIERCE MILLWORK*

*FULL SCALE*

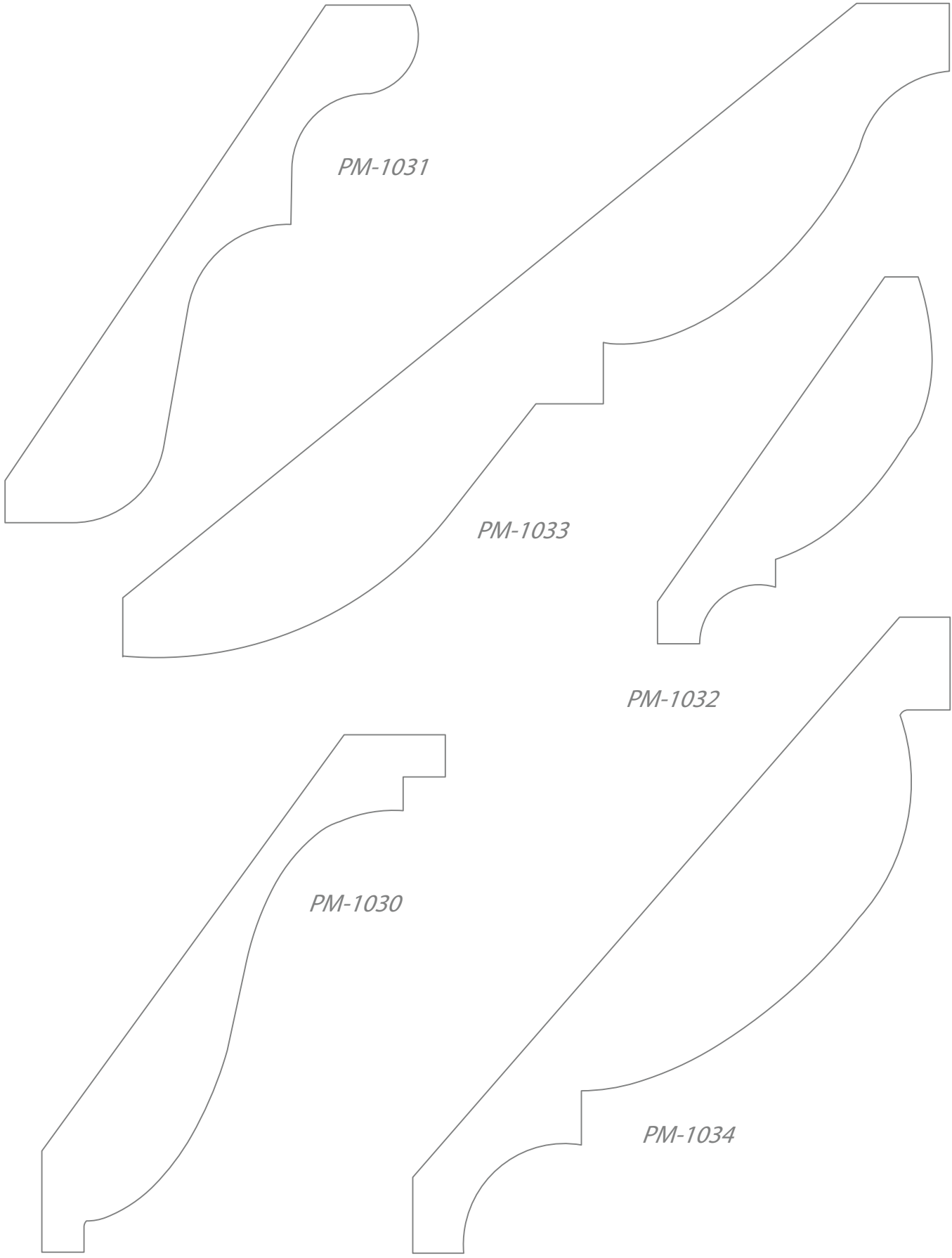

*PM-1031*

*PM-1033*

*PM-1032*

*PM-1030*

*PM-1034*

*PIERCE & PIERCE MILLWORK*

*FULL SCALE*

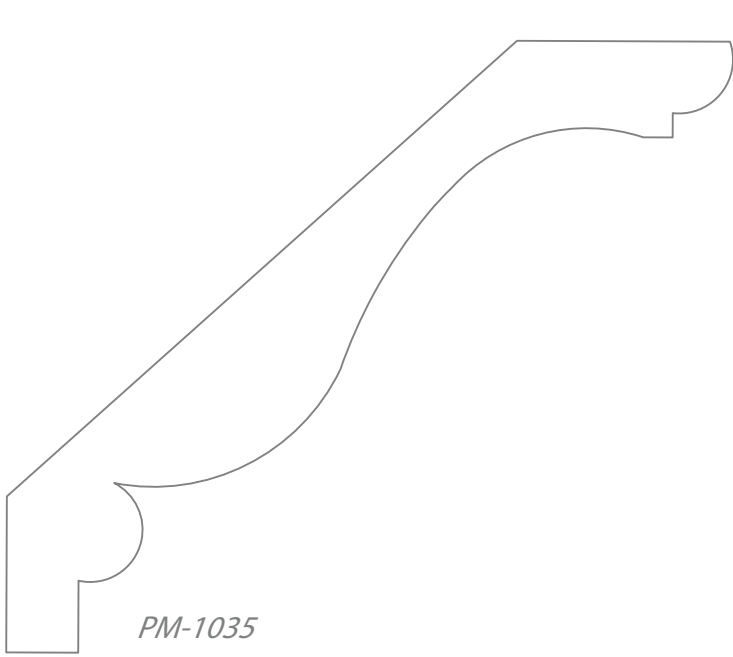

*PM-1035*

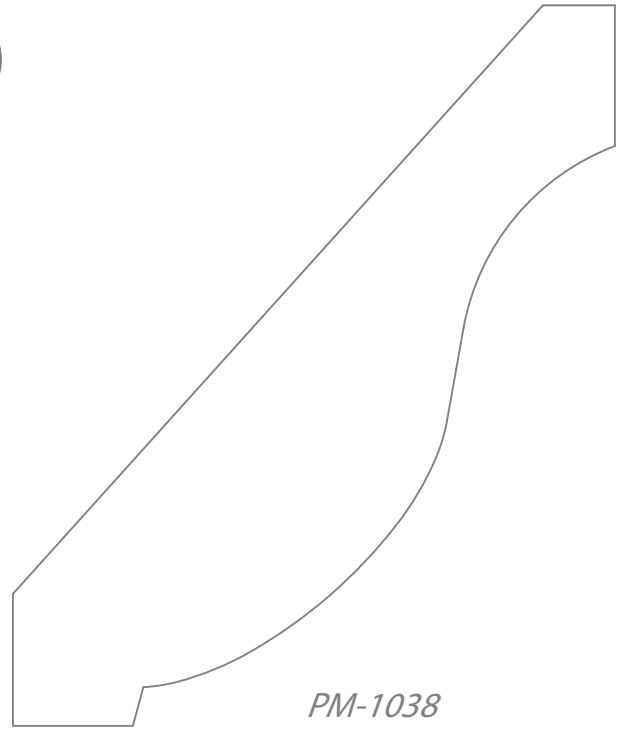

*PM-1038*

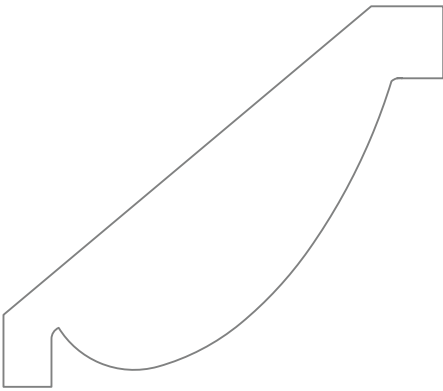

*PM-1036*

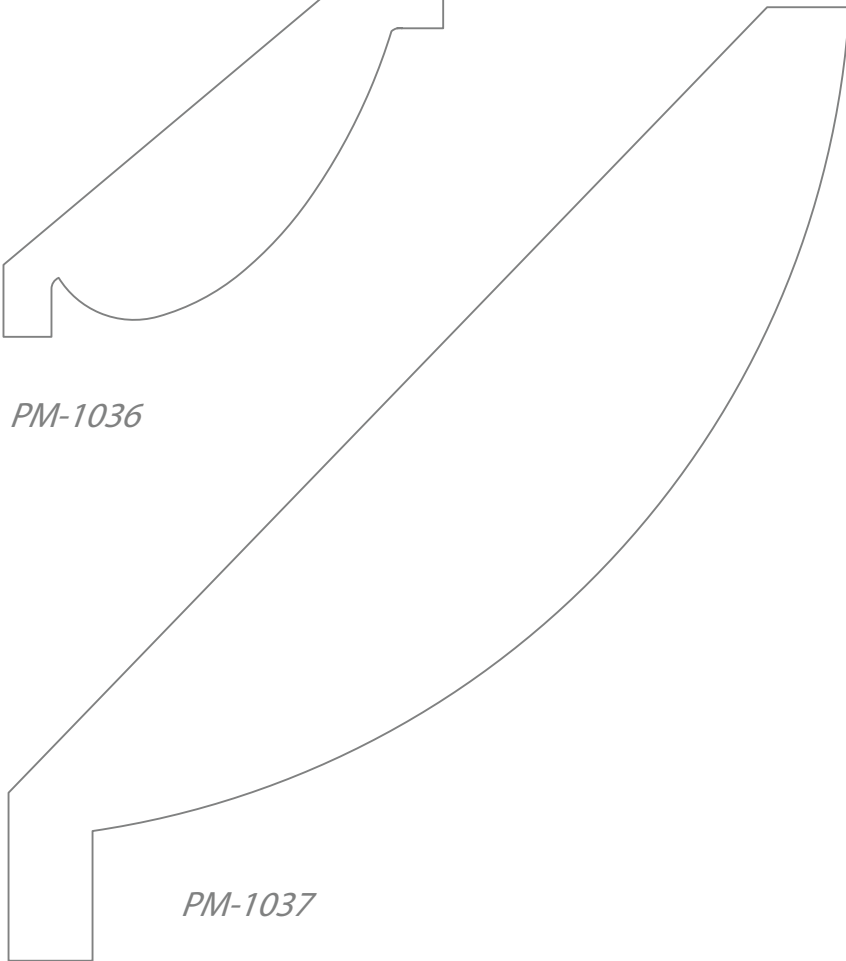

*PM-1037*

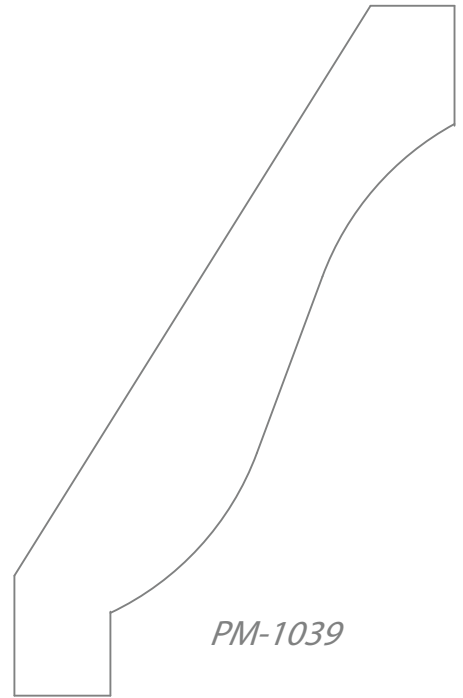

*PM-1039*

# PIERCE & PIERCE MILLWORK

FULL SIZE

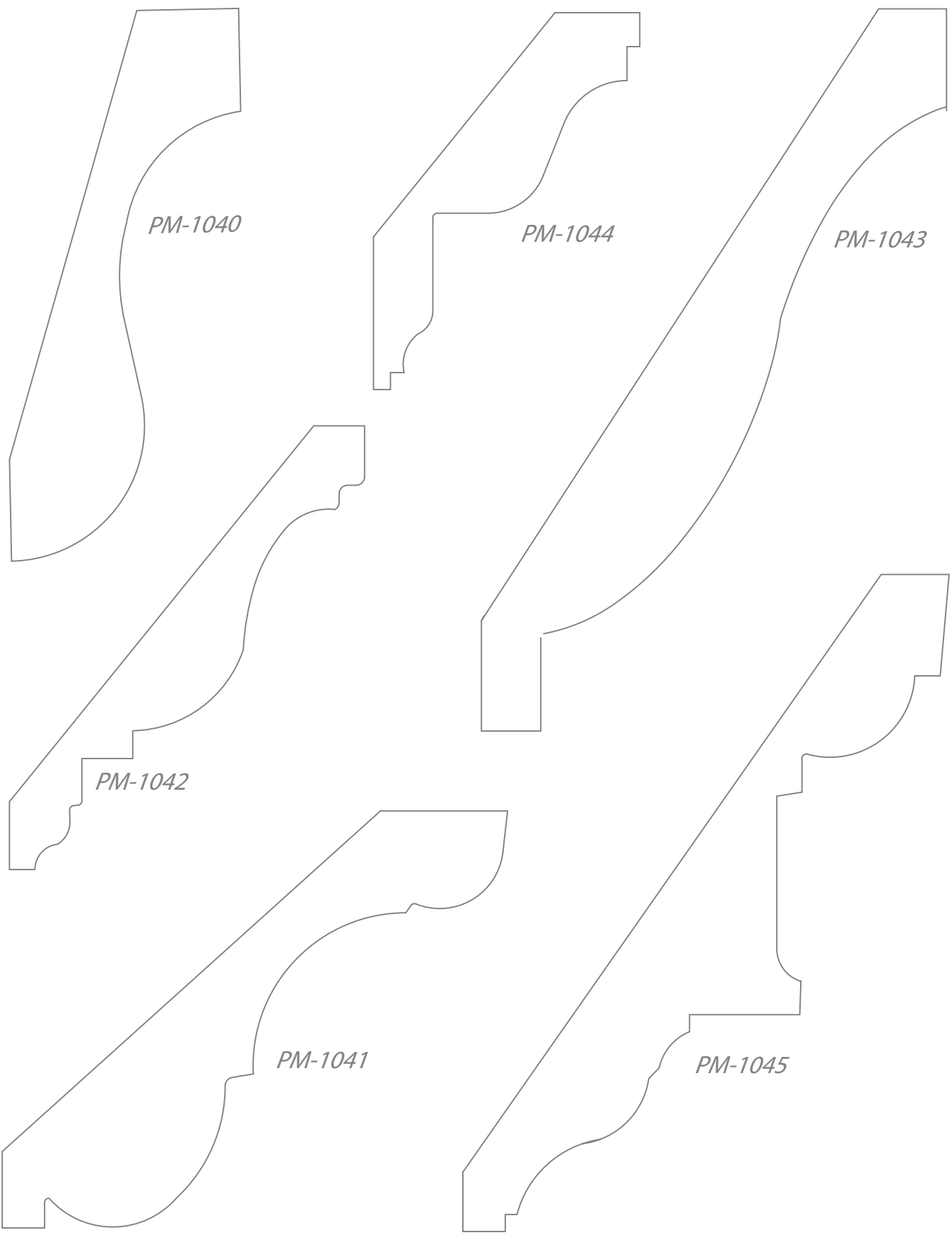

PM-1040

PM-1044

PM-1043

PM-1042

PM-1041

PM-1045

*PIERCE & PIERCE MILLWORK*

*FULL SCALE*

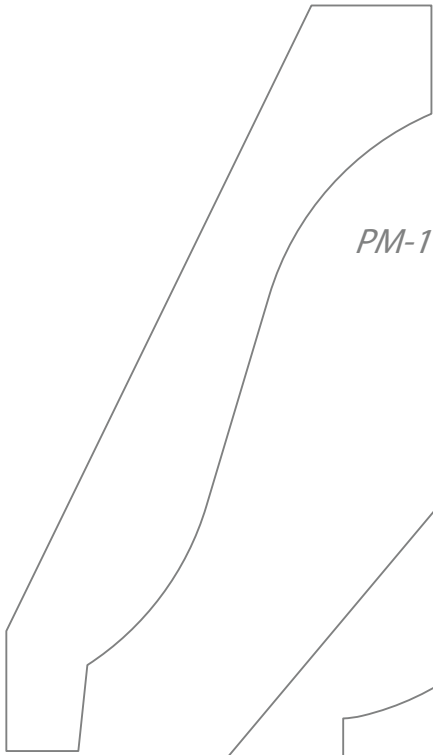

*PM-1052*

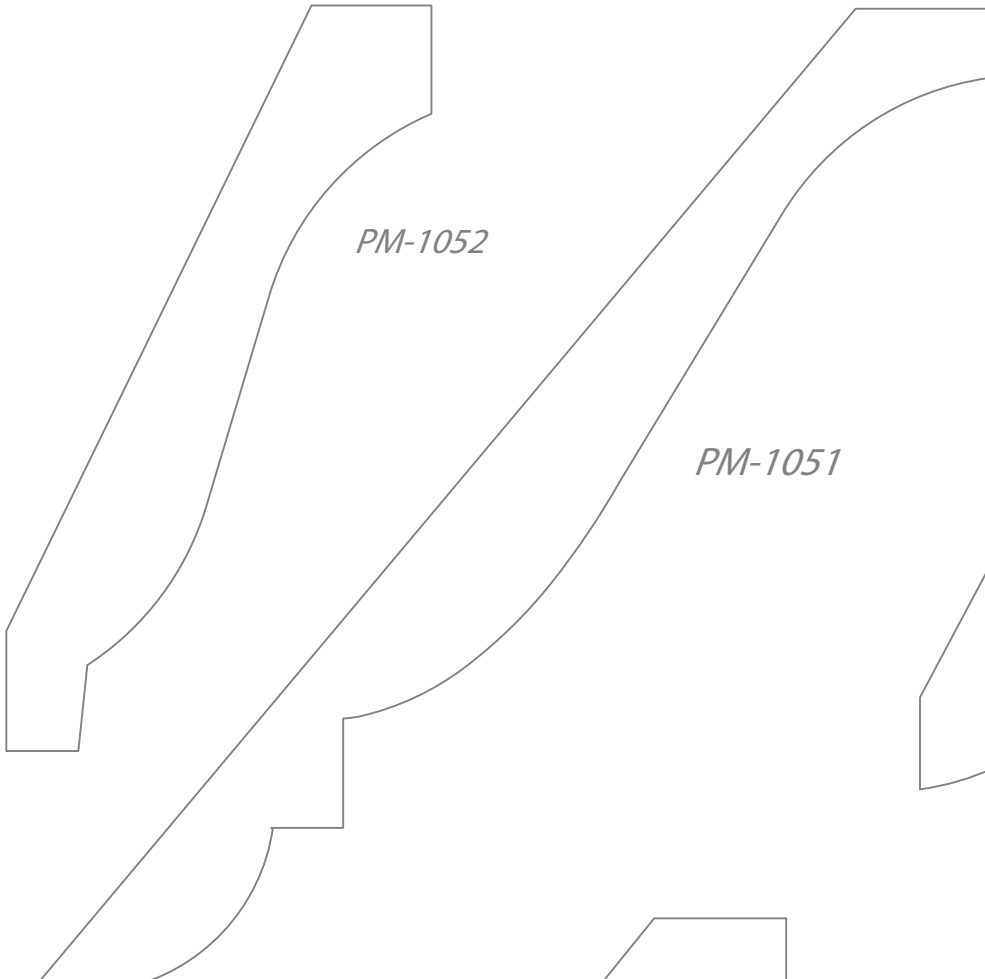

*PM-1051*

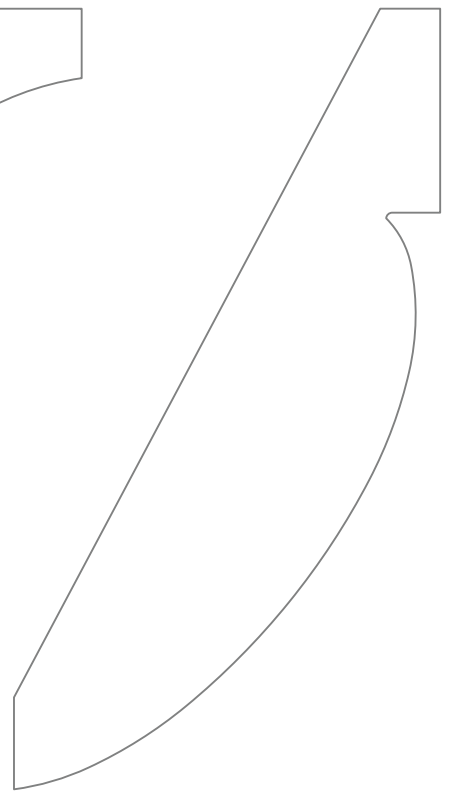

*PM-1049*

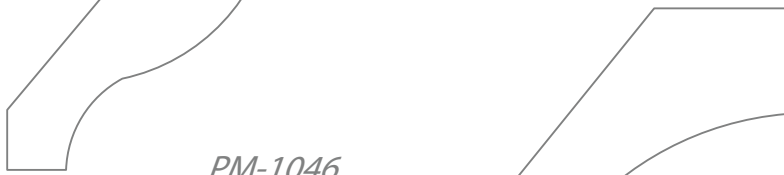

*PM-1046*

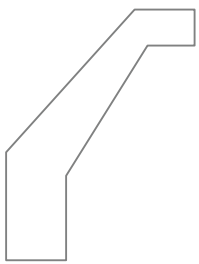

*PM-1047*

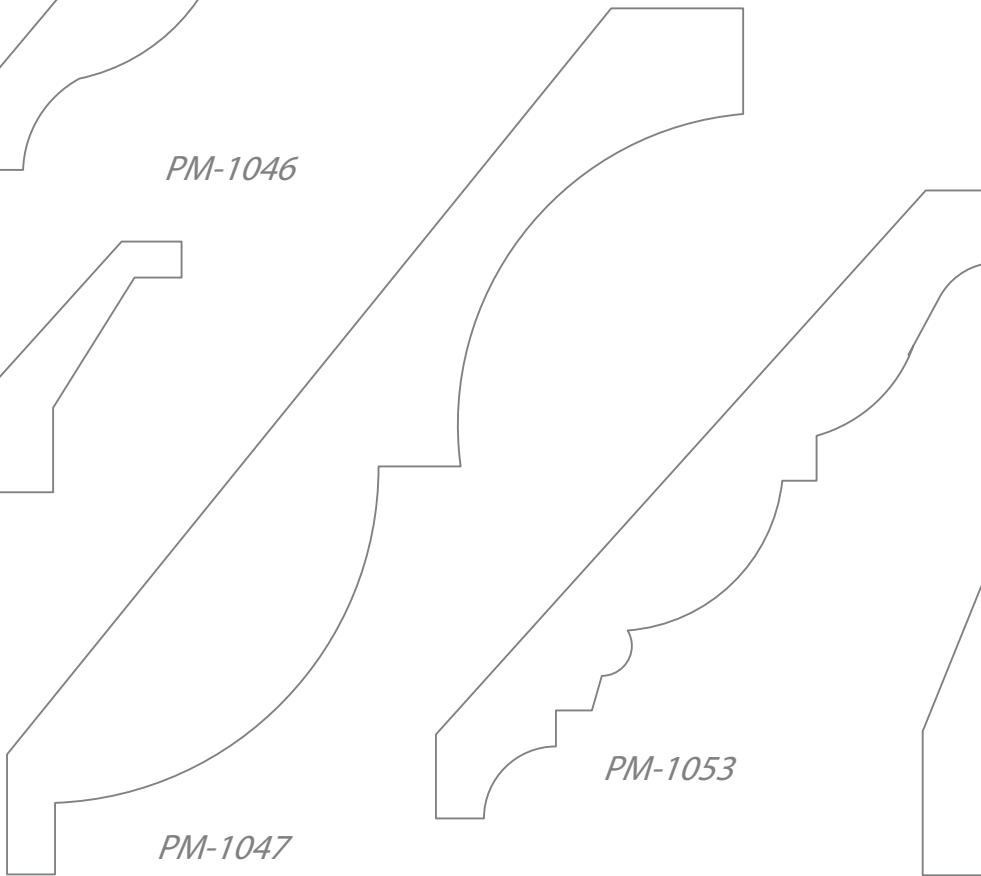

*PM-1053*



*PM-1050*



*PIERCE & PIERCE MILLWORK*

*FULL SCALE*

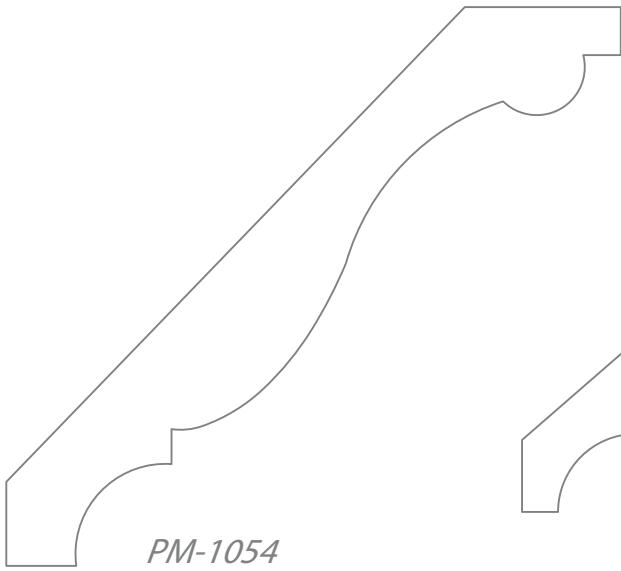

*PM-1054*

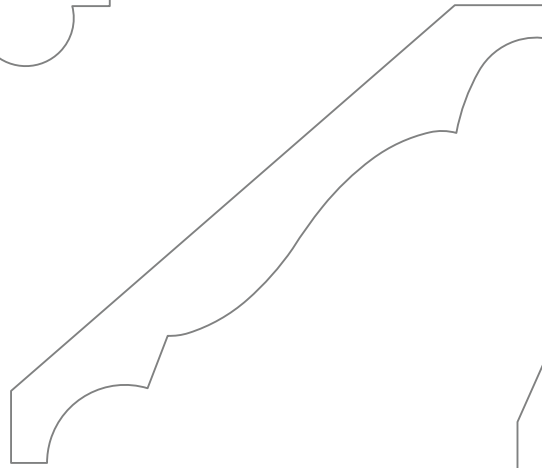

*PM-1062*

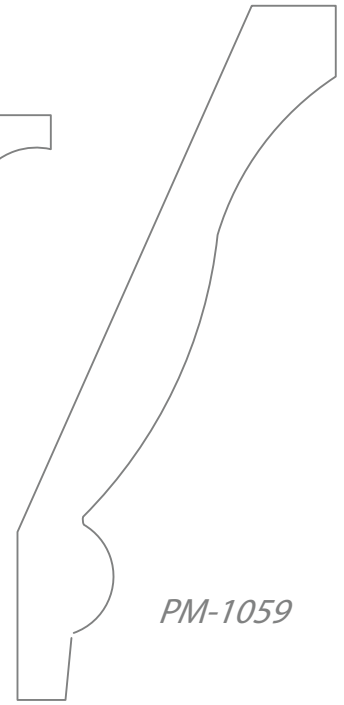

*PM-1059*

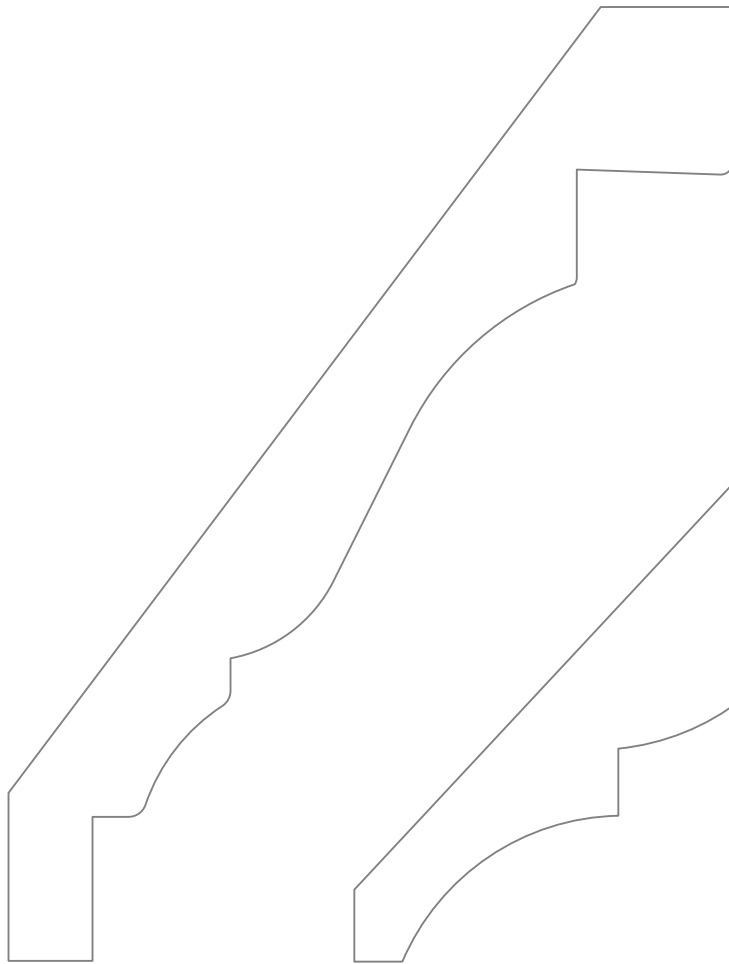

*PM-1055*

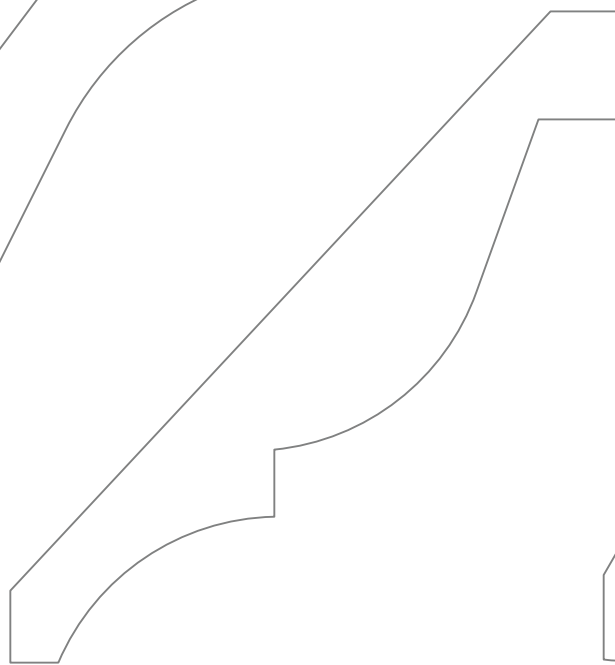

*PM-1060*

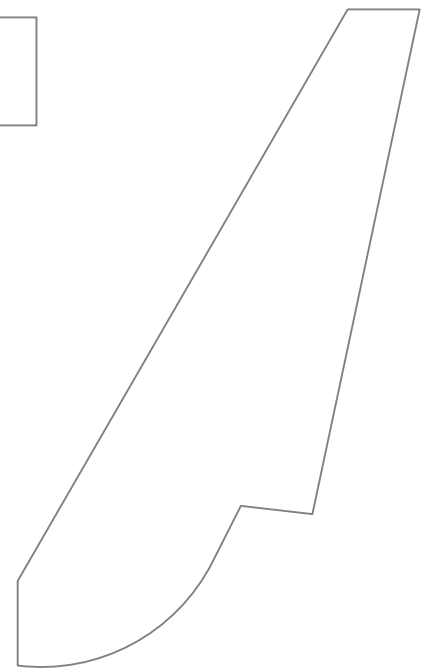

*PM-1061*

*PIERCE & PIERCE MILLWORK*

*FULL SCALE*

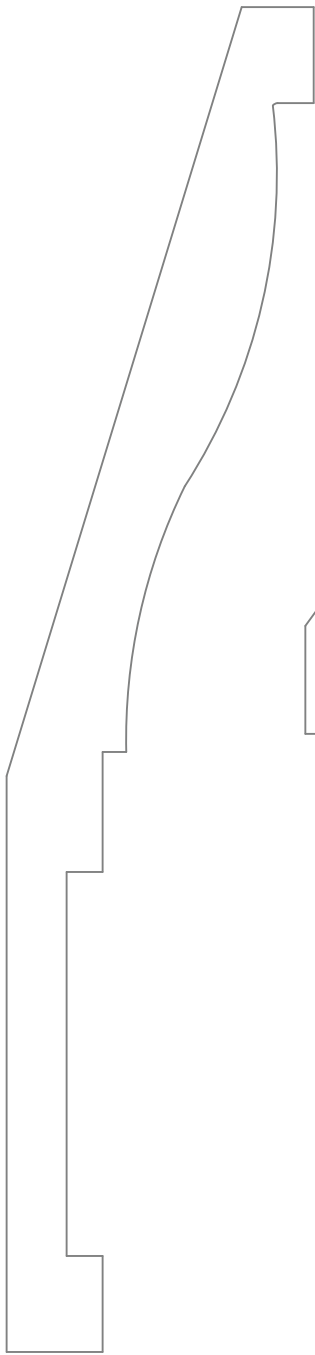

*PM-1068*

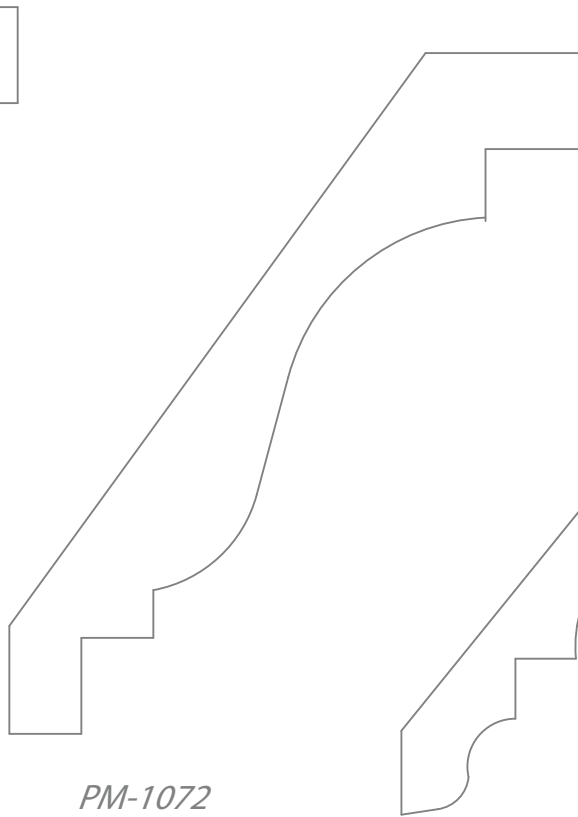

*PM-1072*

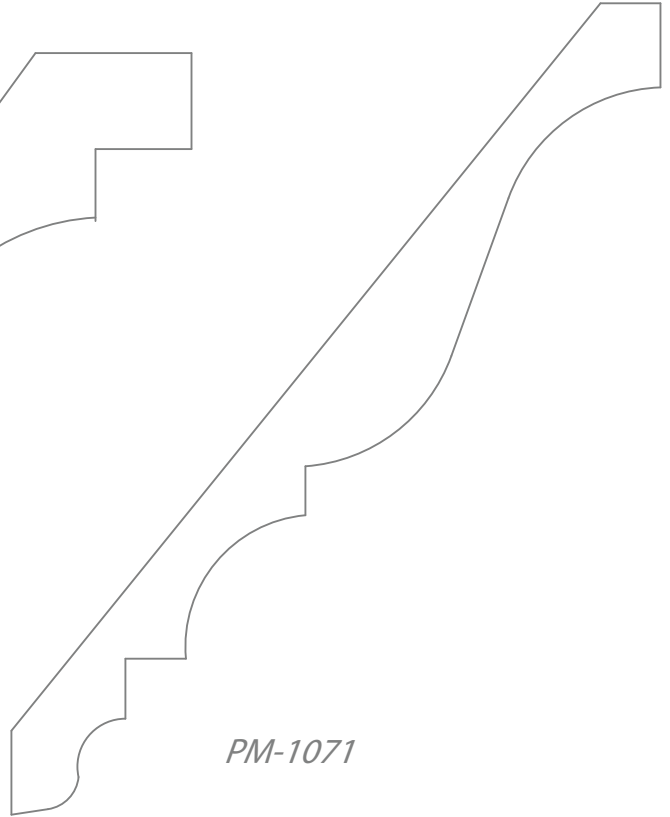

*PM-1071*

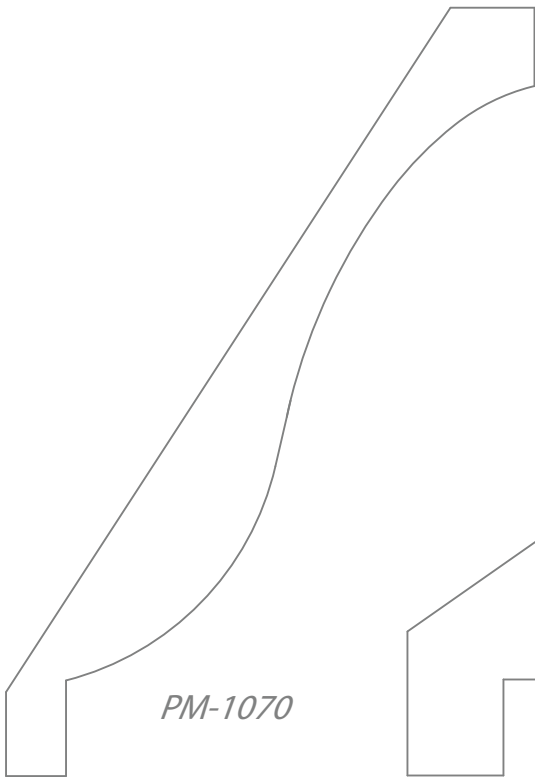

*PM-1070*

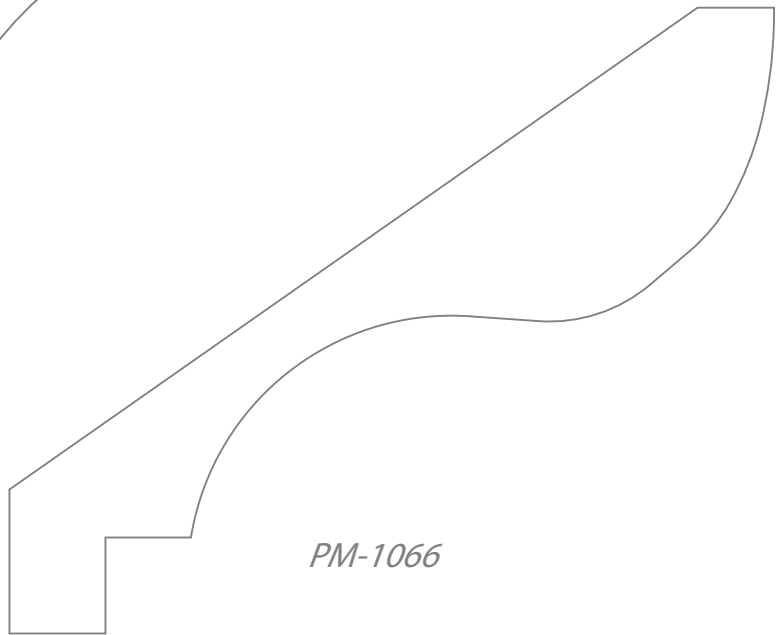

*PM-1066*

*PIERCE & PIERCE MILLWORK*

*FULL SCALE*

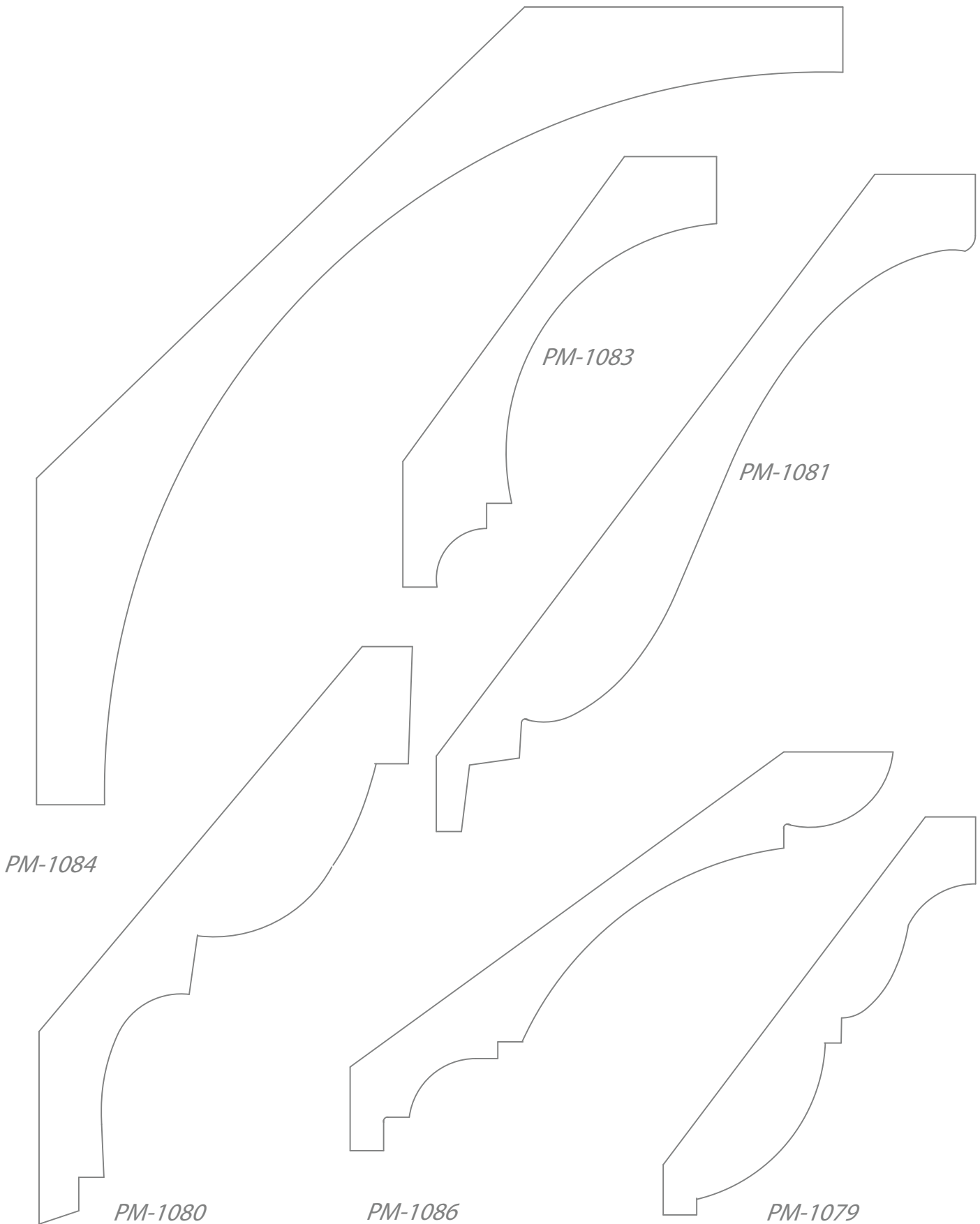

*PIERCE & PIERCE MILLWORK*

*FULL SCALE*

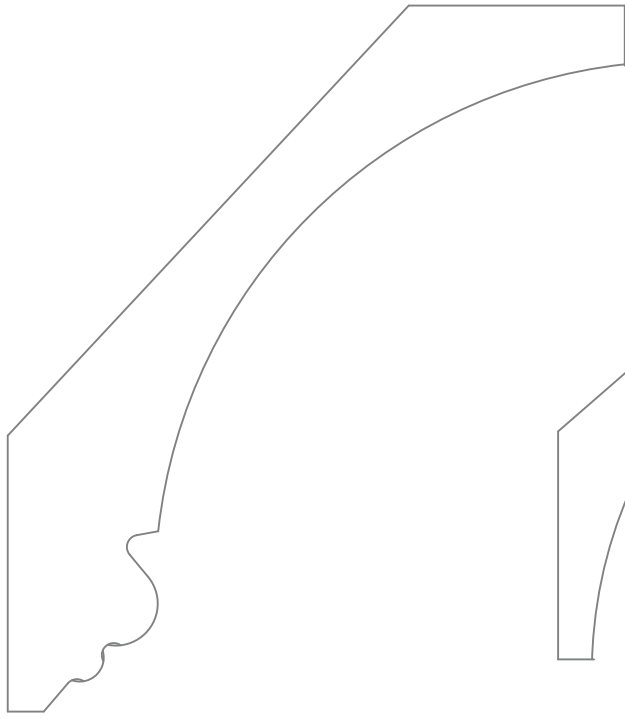

*PM-1087*

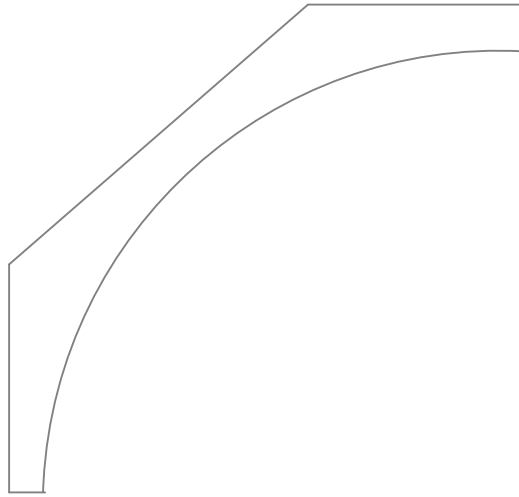

*PM-1093*

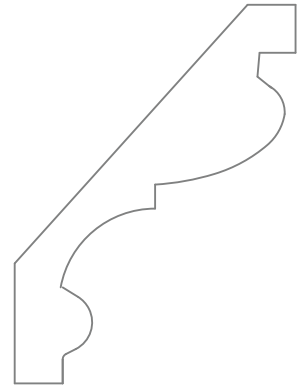

*PM-1092*

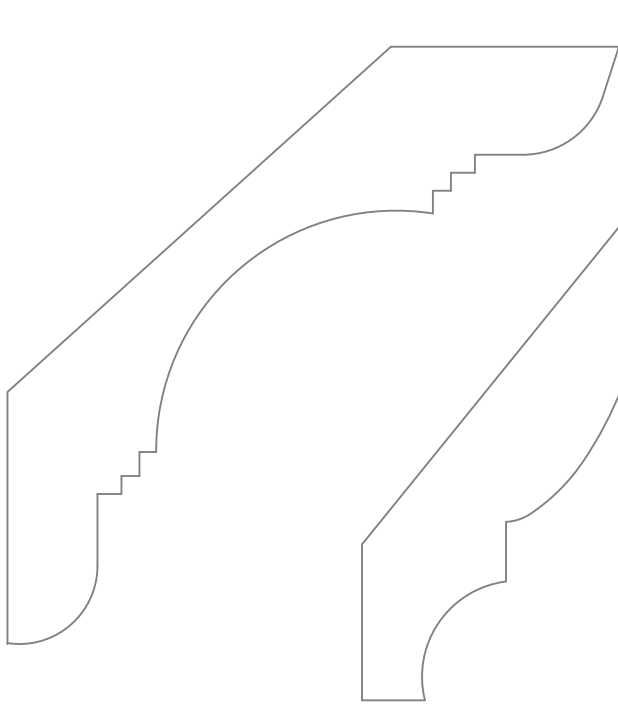

*PM-1090*

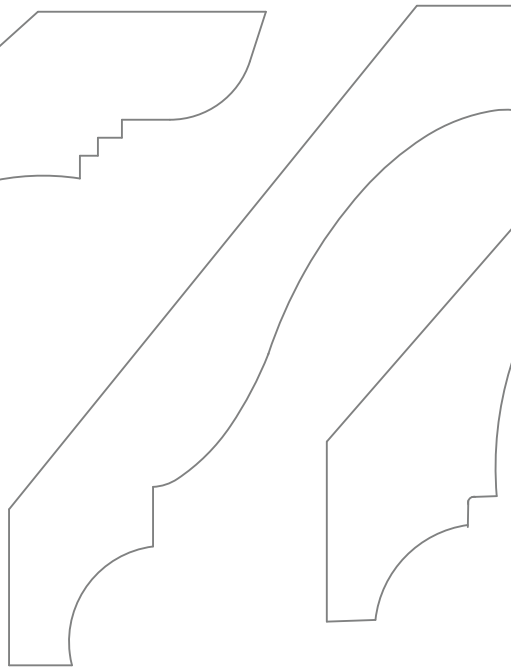

*PM-1001*



*PM-1089*

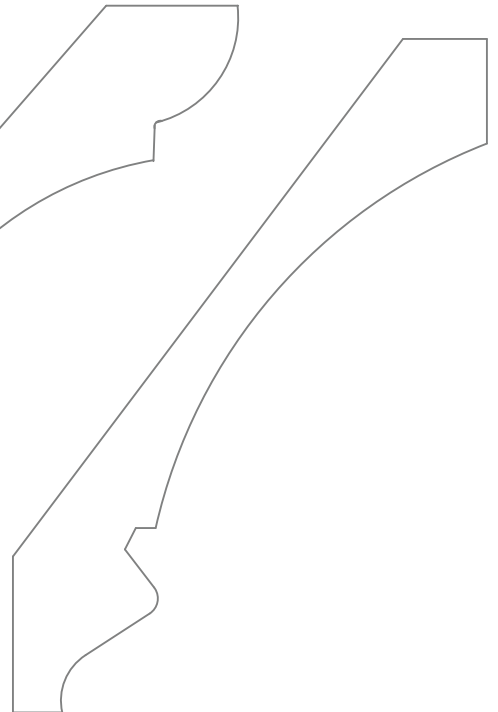

*PM-1088*

*PIERCE & PIERCE MILLWORK*

*FULL SCALE*

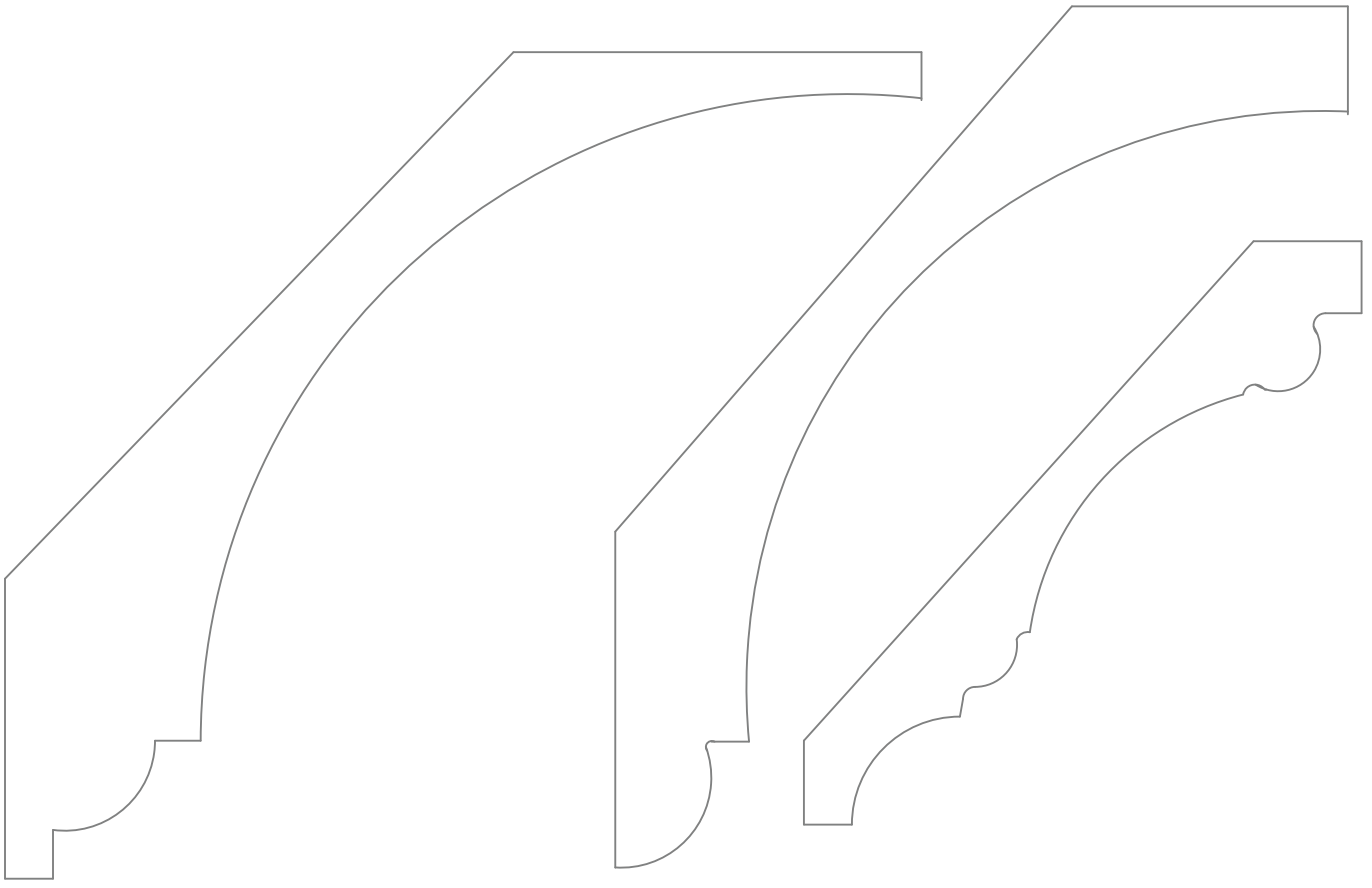

*PM-1096*

*PM-1099*

*PM-1098*

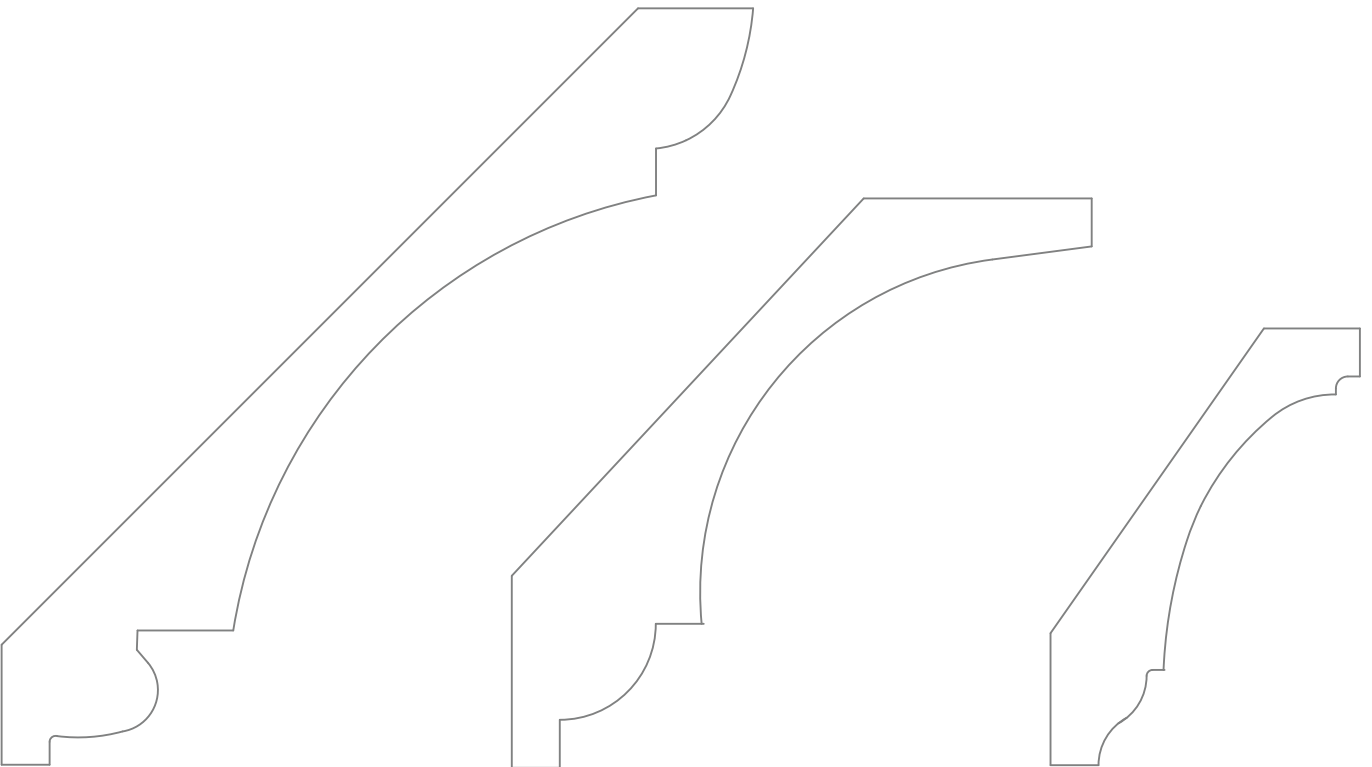

*PM-1097*

*PM-1095*

*PM-1094*

*PIERCE & PIERCE MILLWORK*

*FULL SCALE*

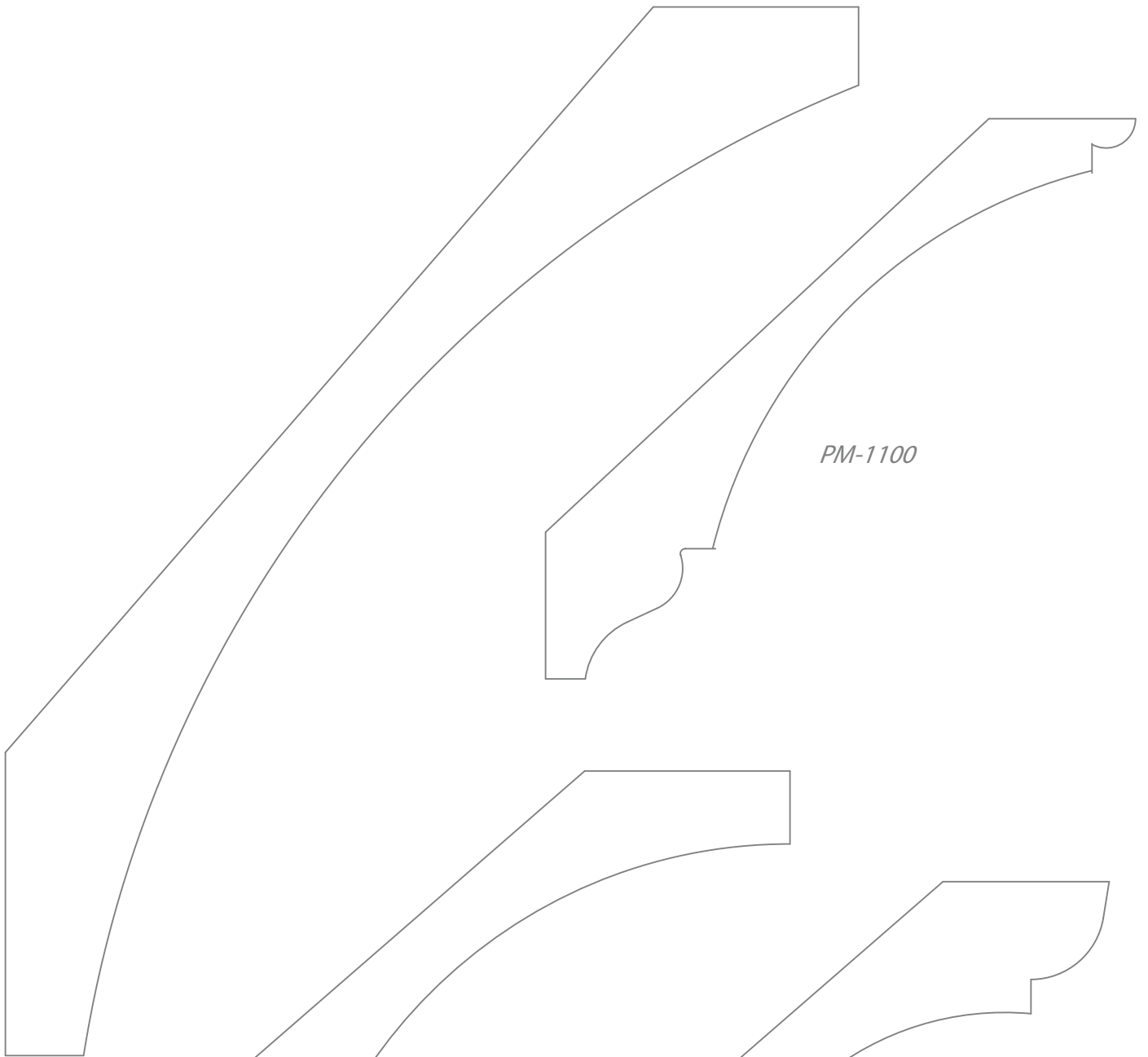

*PM-1108*

*PM-1107*

*PM-1102*

*PM-1100*

# PIERCE & PIERCE MILLWORK

## FULL SCALE

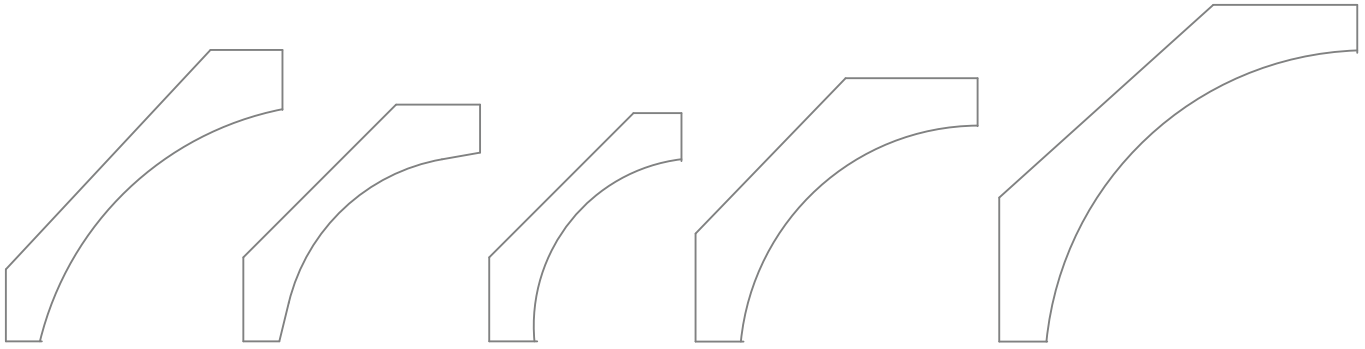

PM-1105

PM-1104

PM-1106

PM-1113

PM-1110

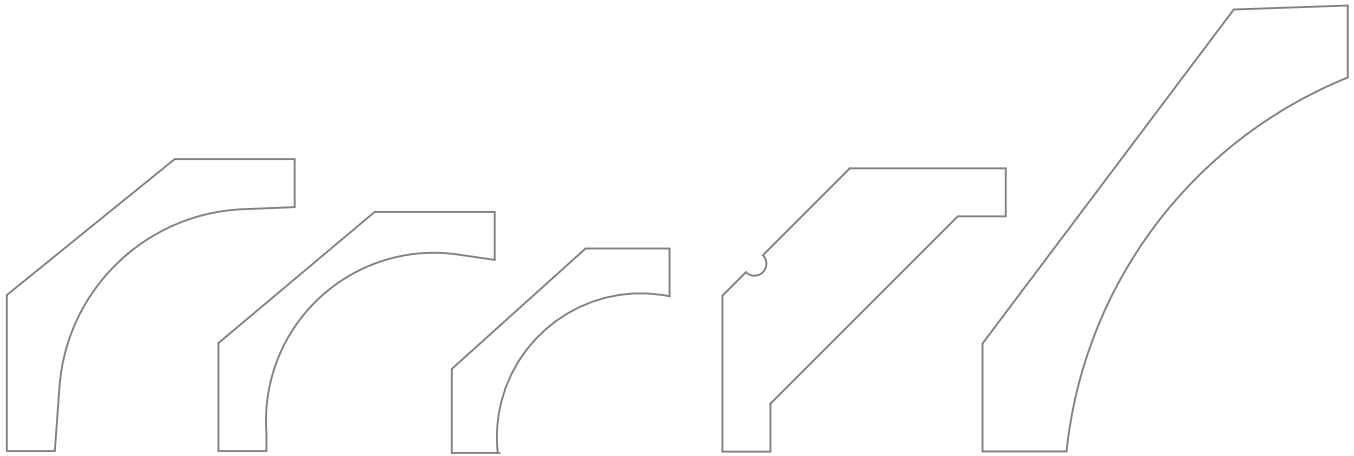

PM-1117

PM-1118

PM-1121

PM-1146

PM-1129

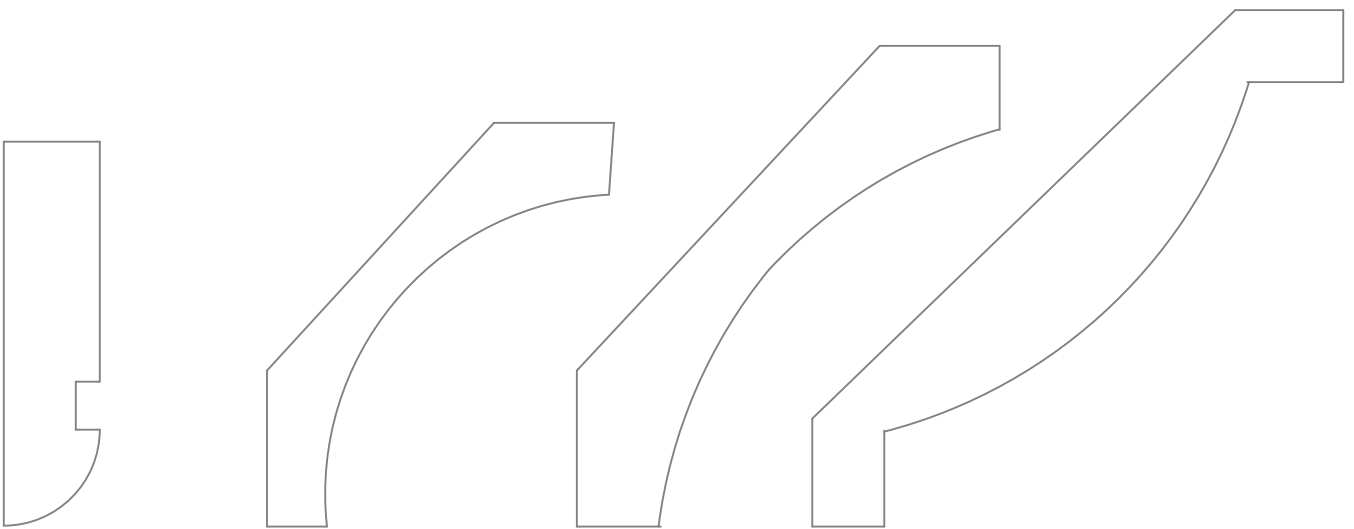

PM-1144

PM-1124

PM-1114

PM-1125

*PIERCE & PIERCE MILLWORK*

*FULL SCALE*

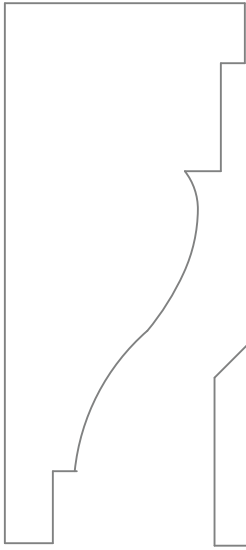

*PM-1109*

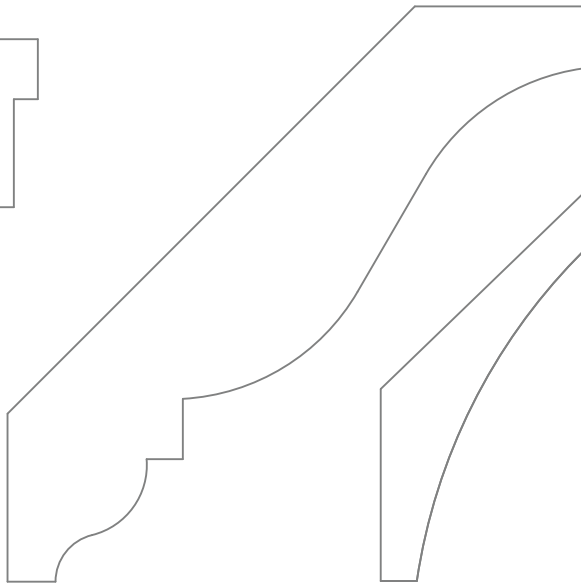

*PM-1143*

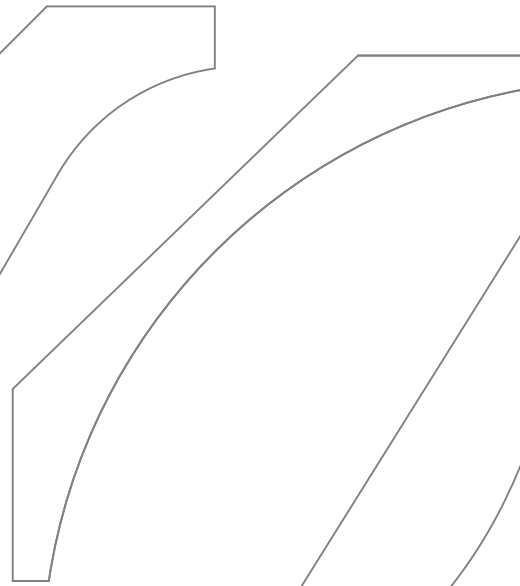

*PM-1111*

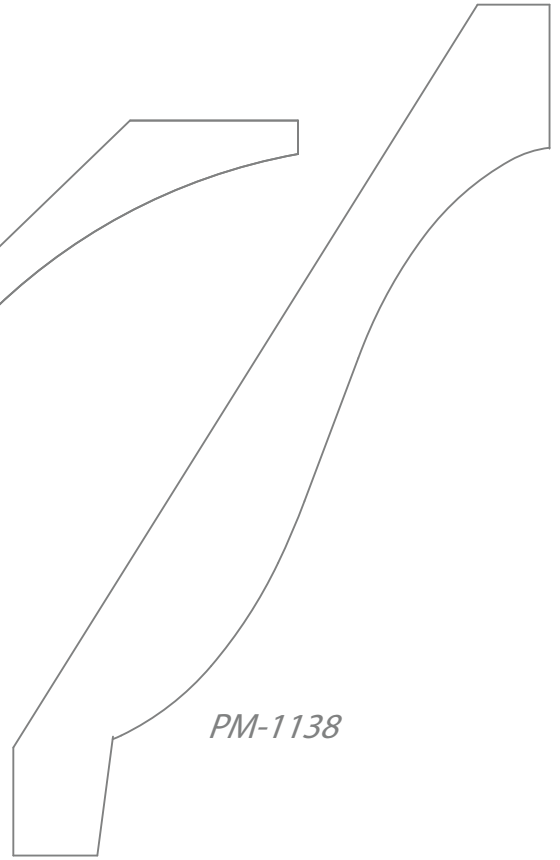

*PM-1138*

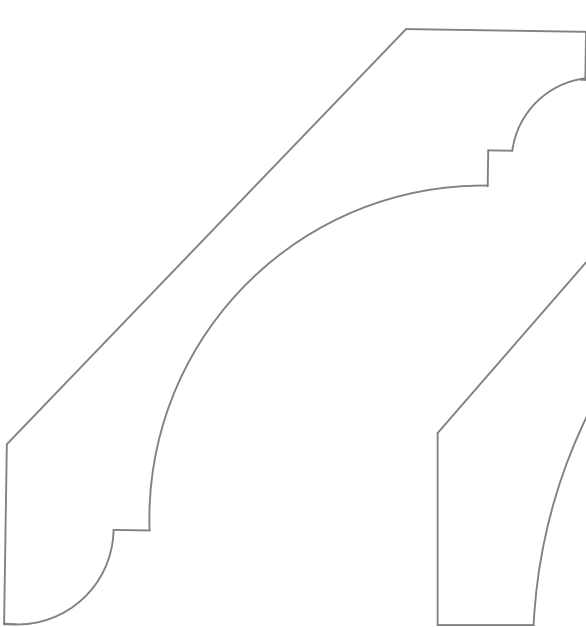

*PM-1112*

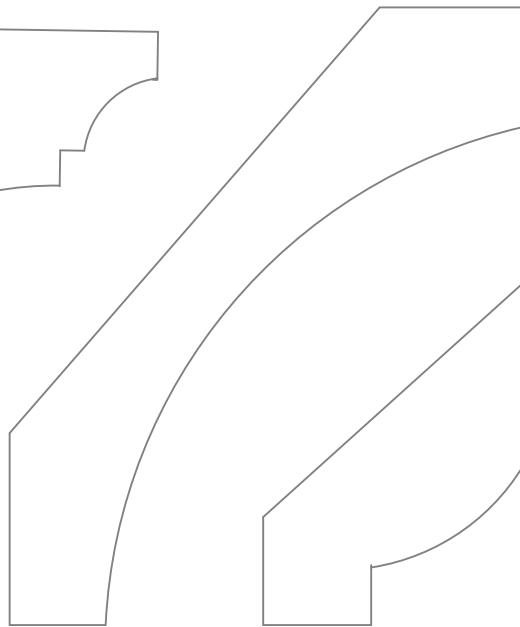

*PM-1123*

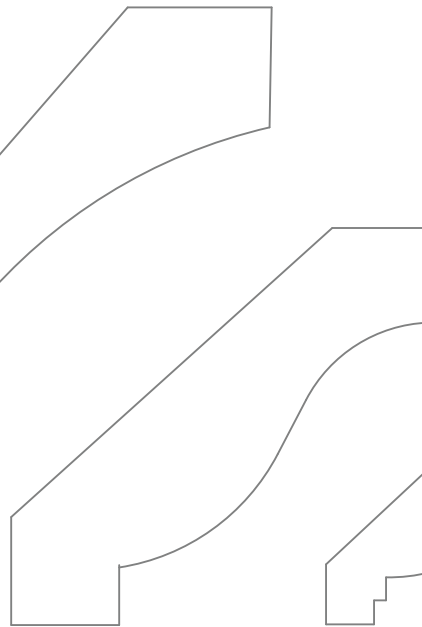

*PM-1141*

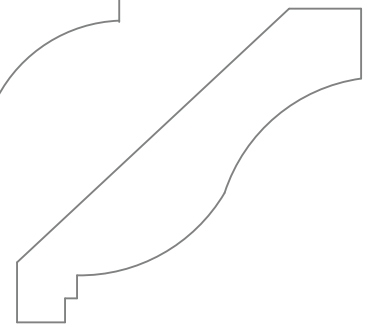

*PM-1154*



*PIERCE & PIERCE MILLWORK*

*FULL SCALE*

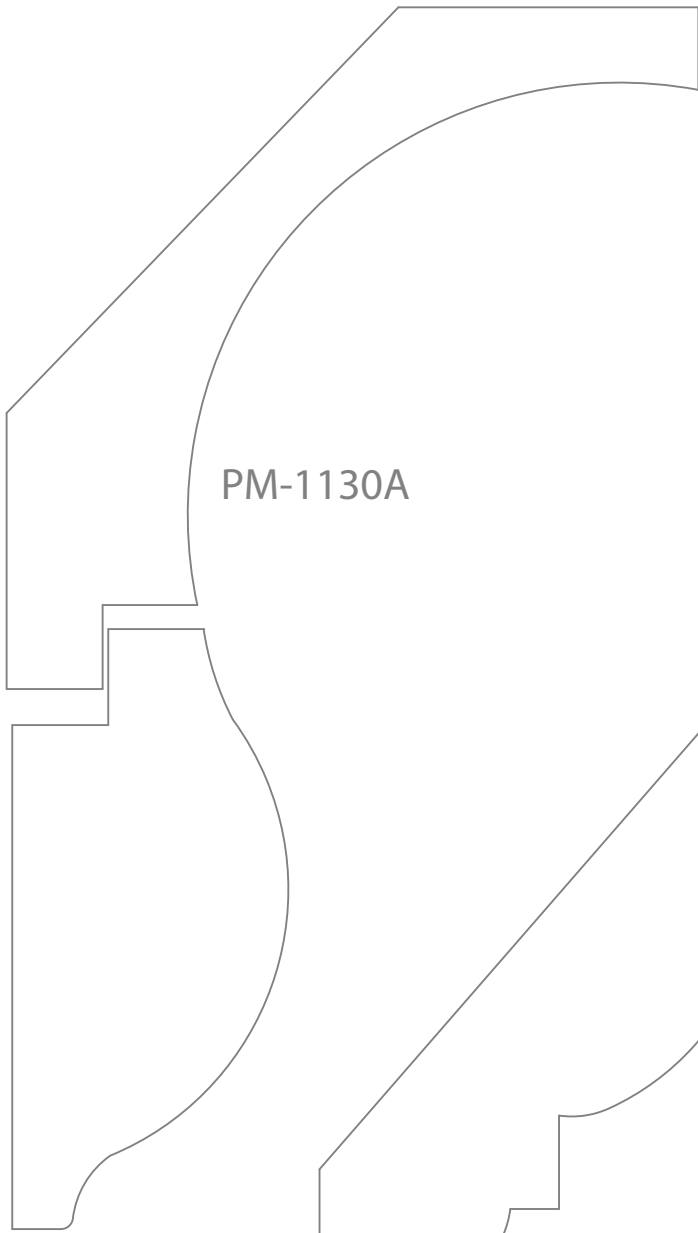

PM-1130A

PM-1130B



PM-1140

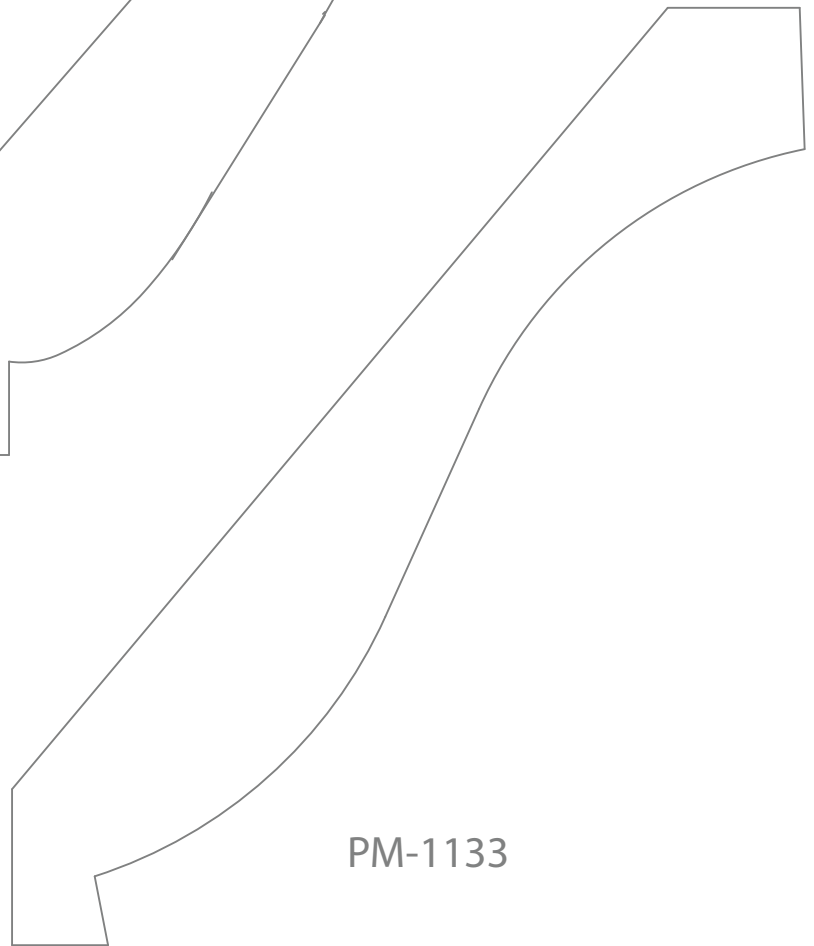

PM-1133

*PIERCE & PIERCE MILLWORK*

*FULL SCALE*

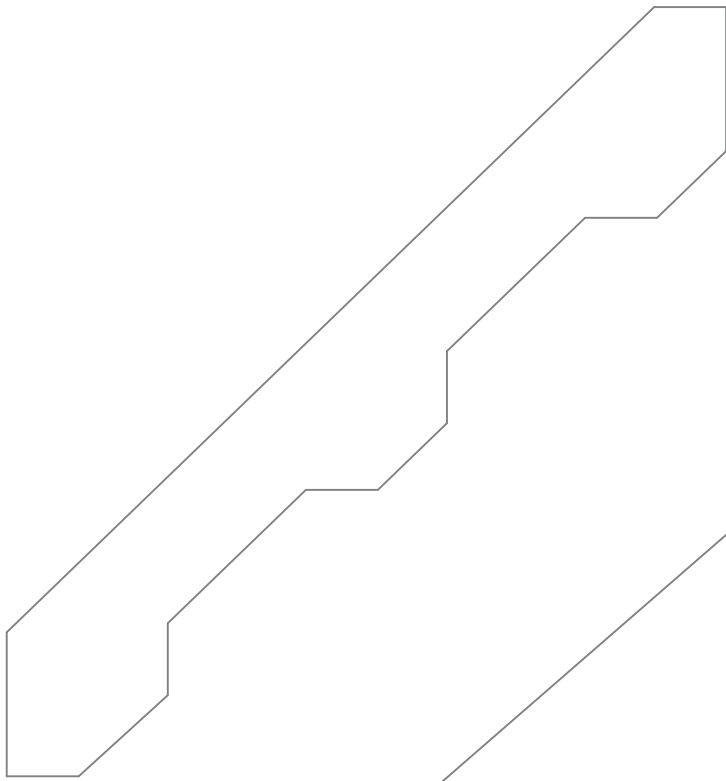

PM-1137



PM-1115



PM-1122

*PIERCE & PIERCE MILLWORK*

*FULL SCALE*

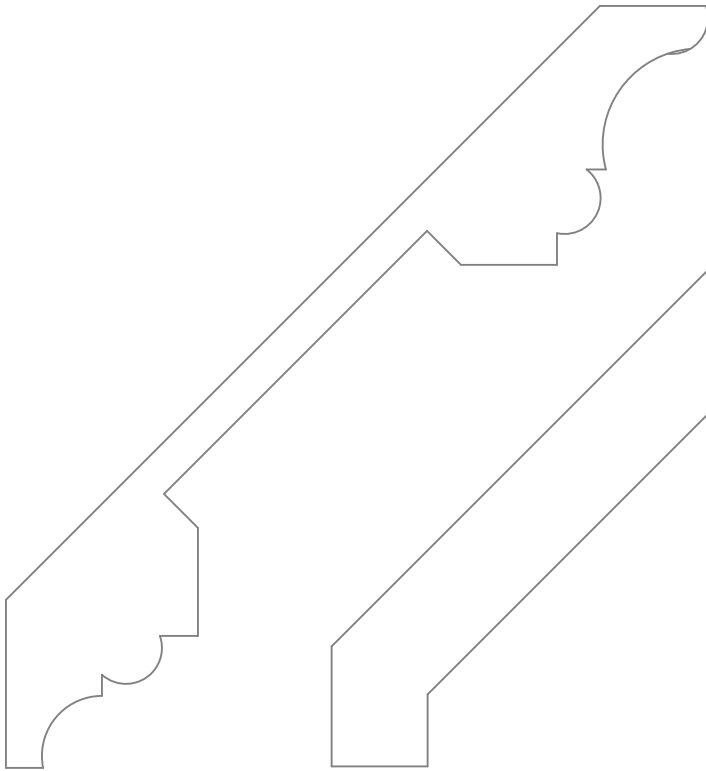

*PM-1132*

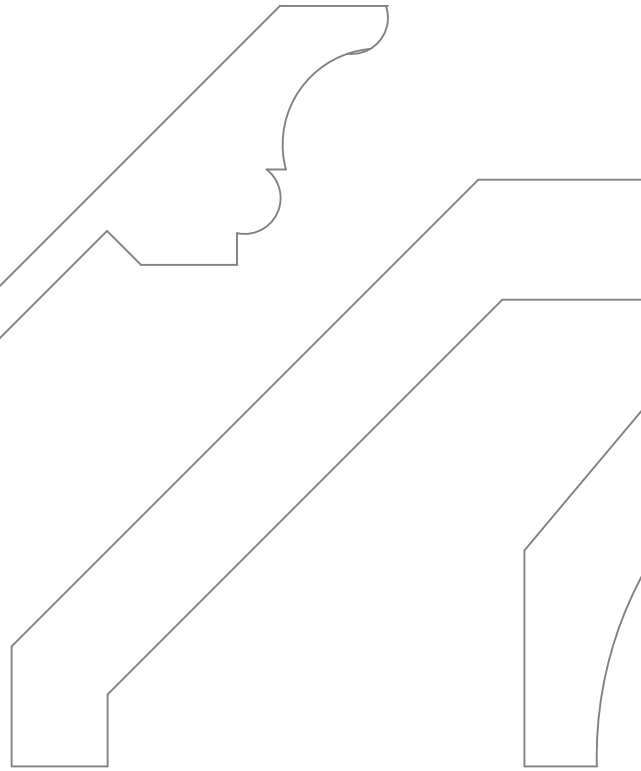

*PM-1142*

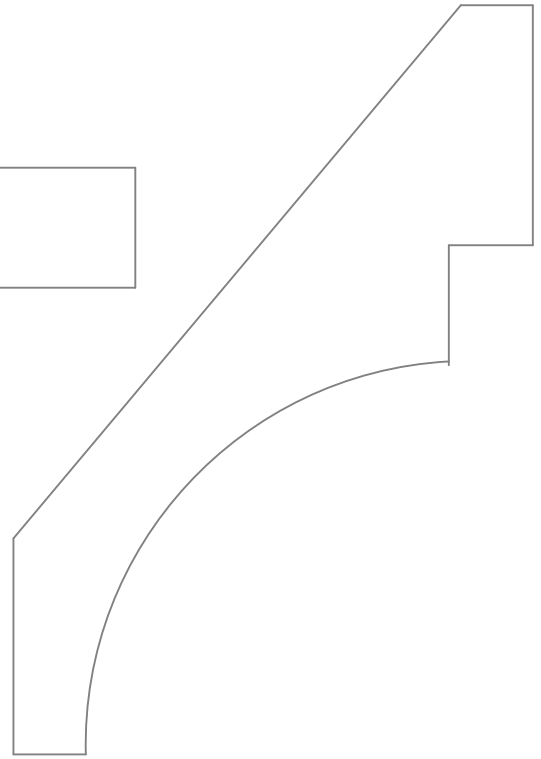

*PM-1171*

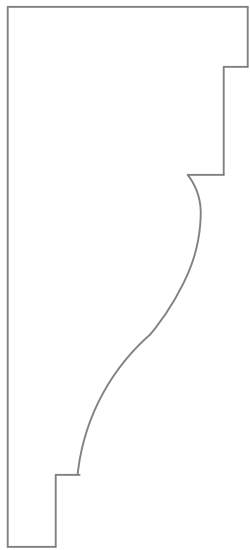

*PM-1139*

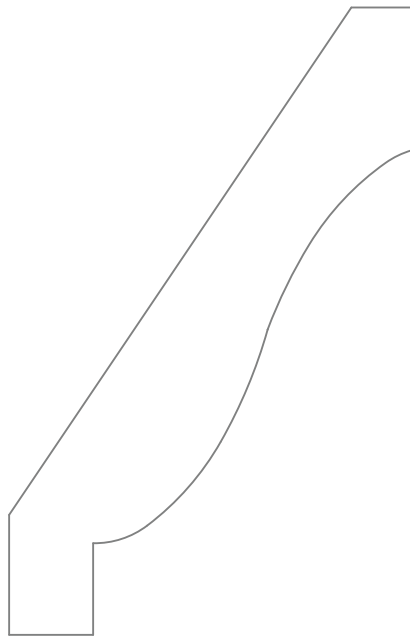

*PM-1168*

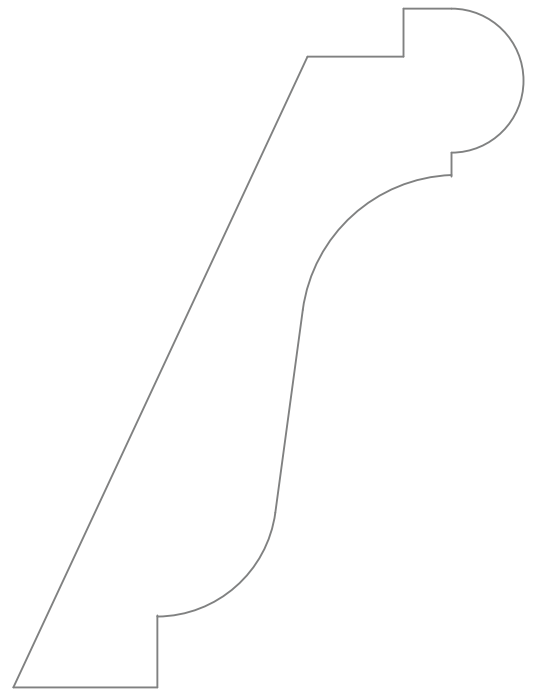

*PM-1155*

*PIERCE & PIERCE MILLWORK*

*FULL SCALE*

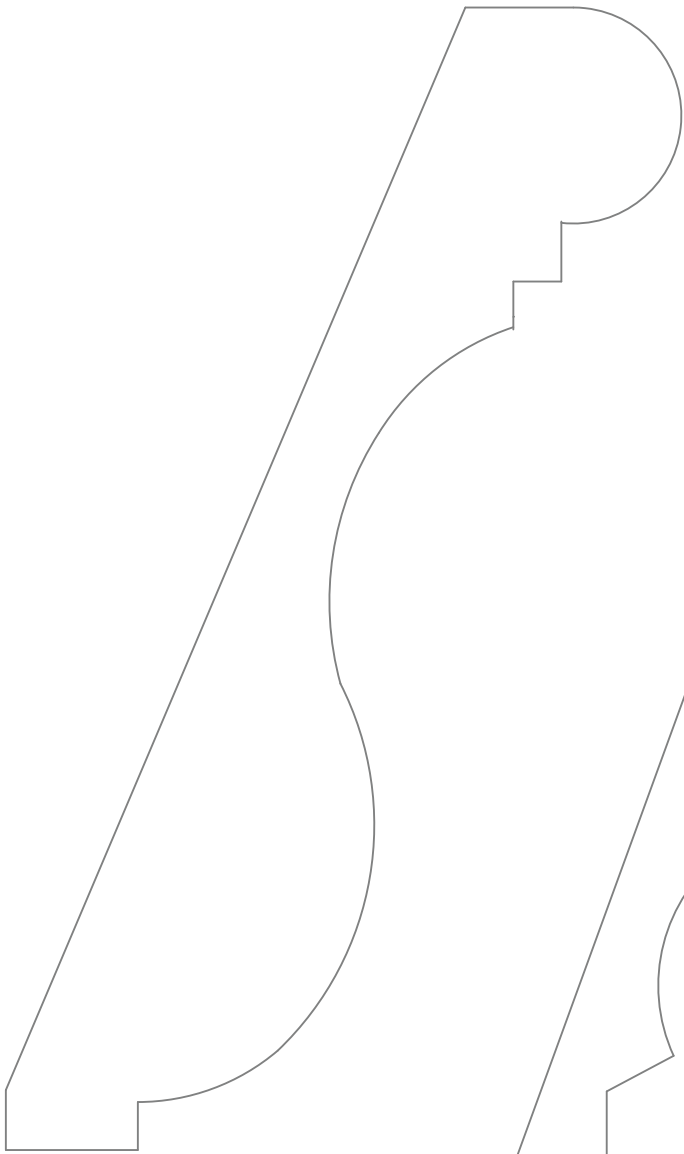

*PM-1147*

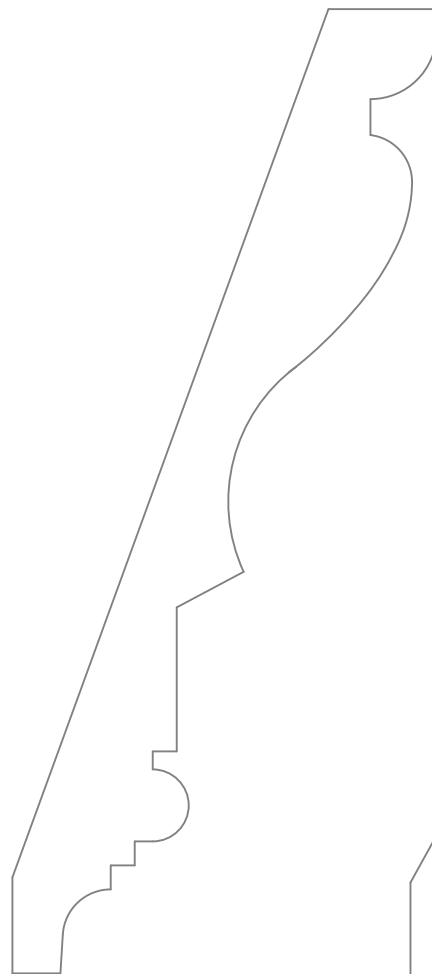

*PM-1153*

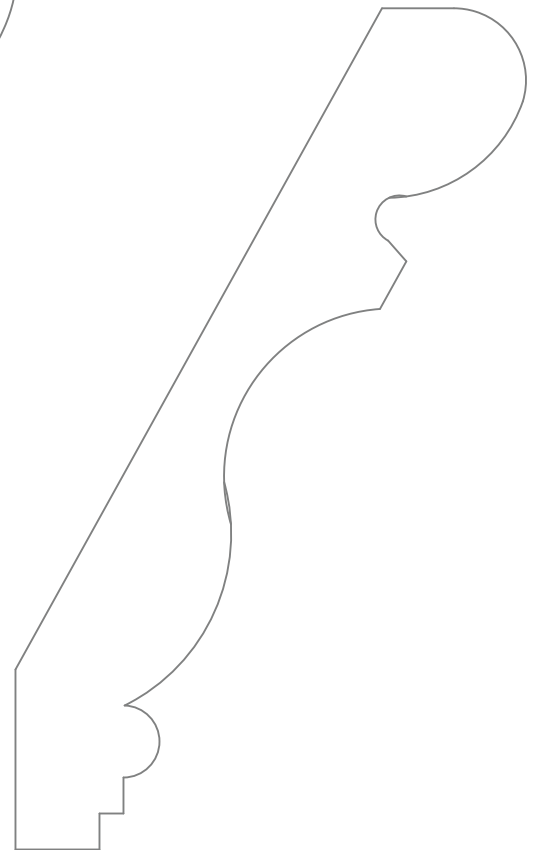

*PM-1151*

*PIERCE & PIERCE MILLWORK*

*FULL SCALE*

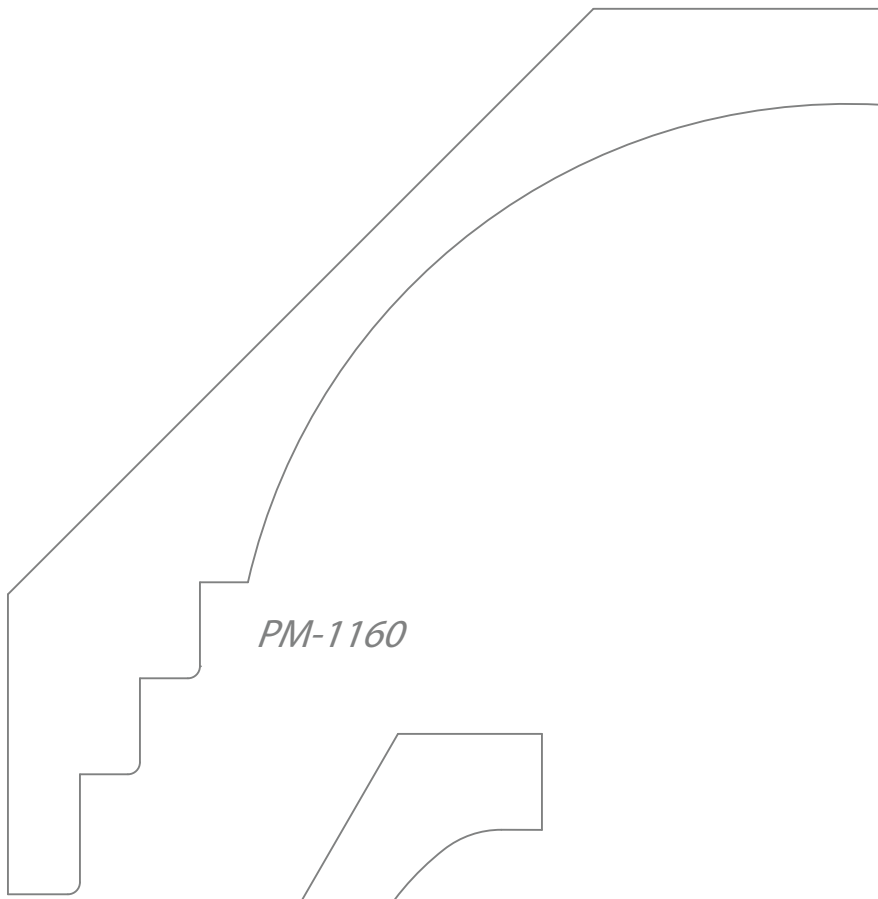

*PM-1160*

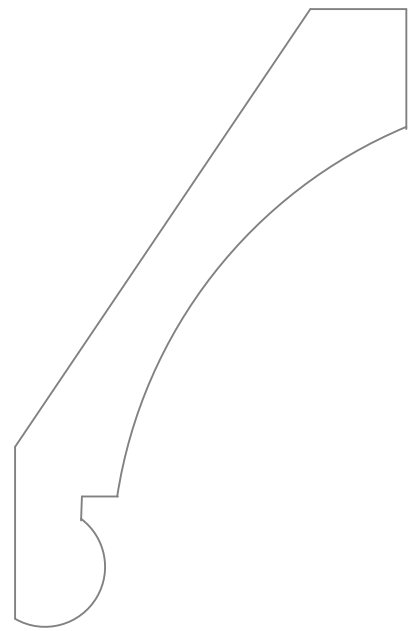

*PM-1175*

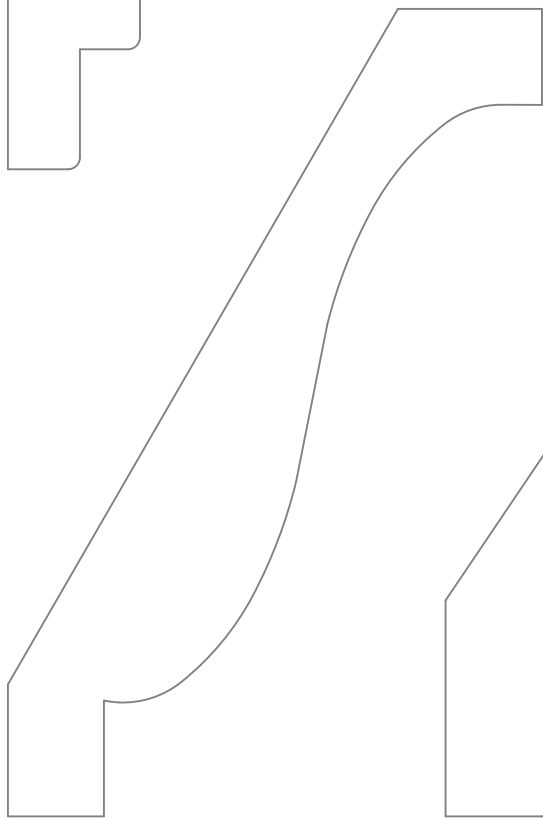

*PM-1182*

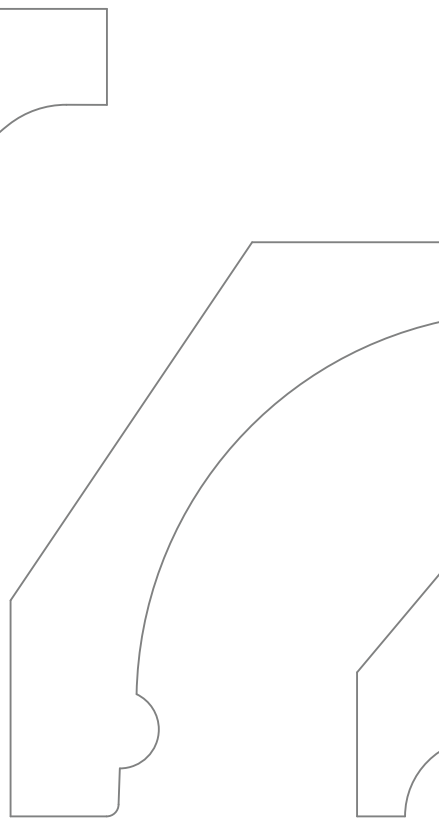

*PM-1185*

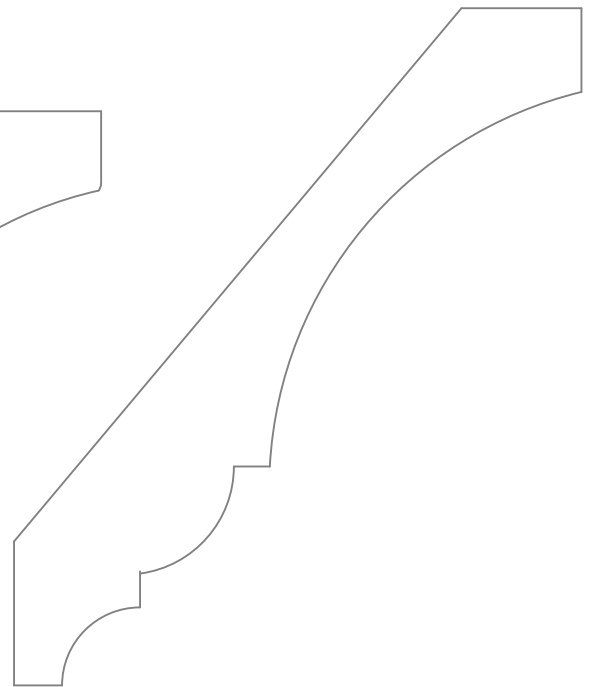

*PM-1176*

*PIERCE & PIERCE MILLWORK*

*FULL SCALE*

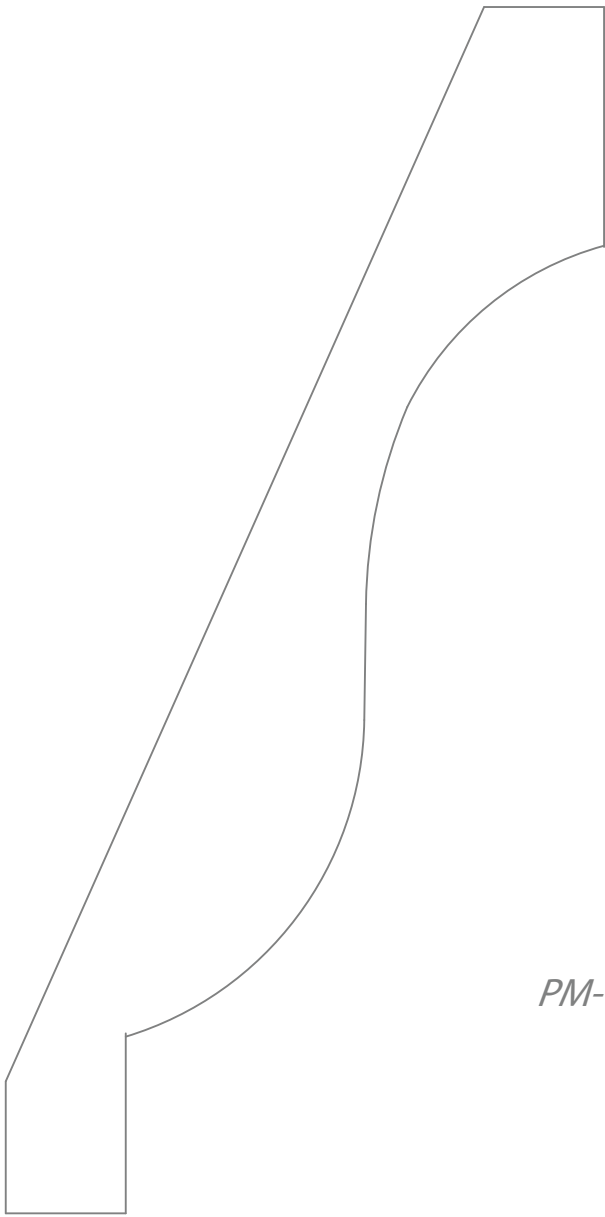

*PM-1180*

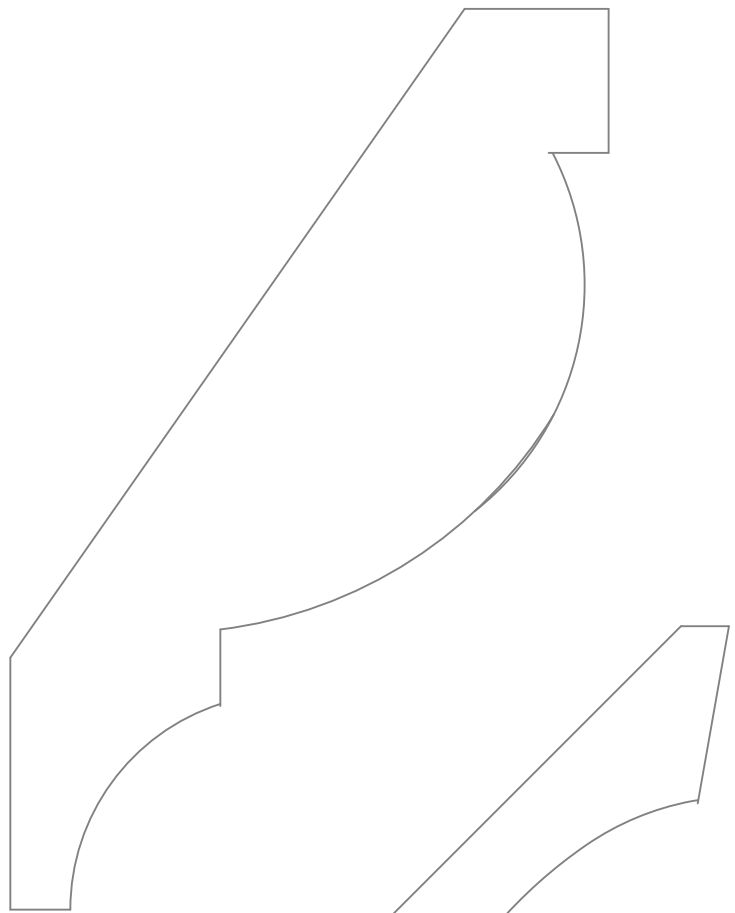

*PM-1164*

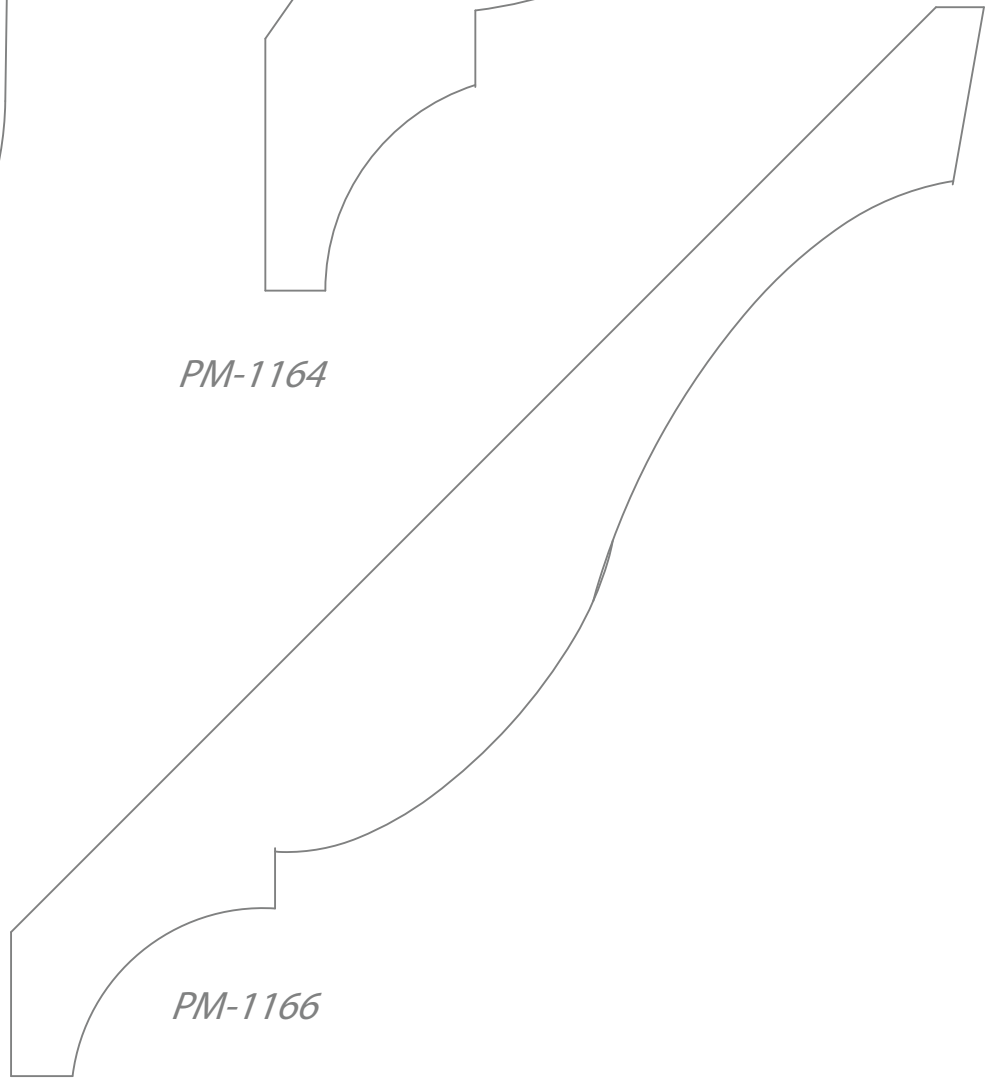

*PM-1166*

*PIERCE & PIERCE MILLWORK*

*FULL SCALE*

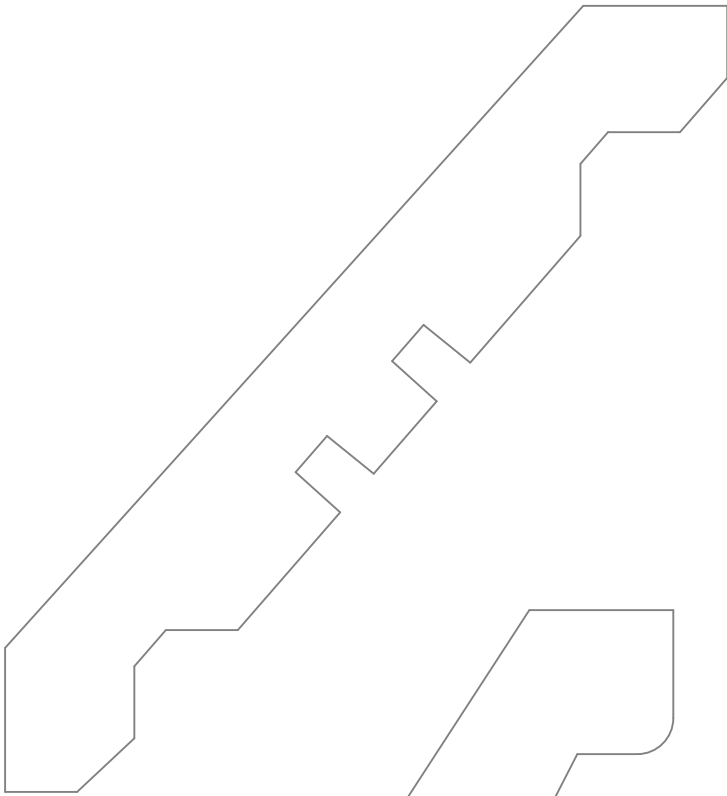

*PM-1162*

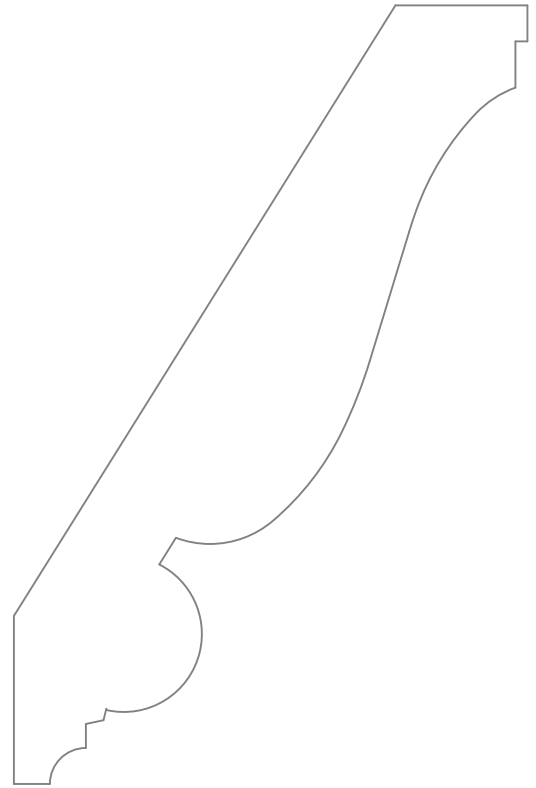

*PM-1165*

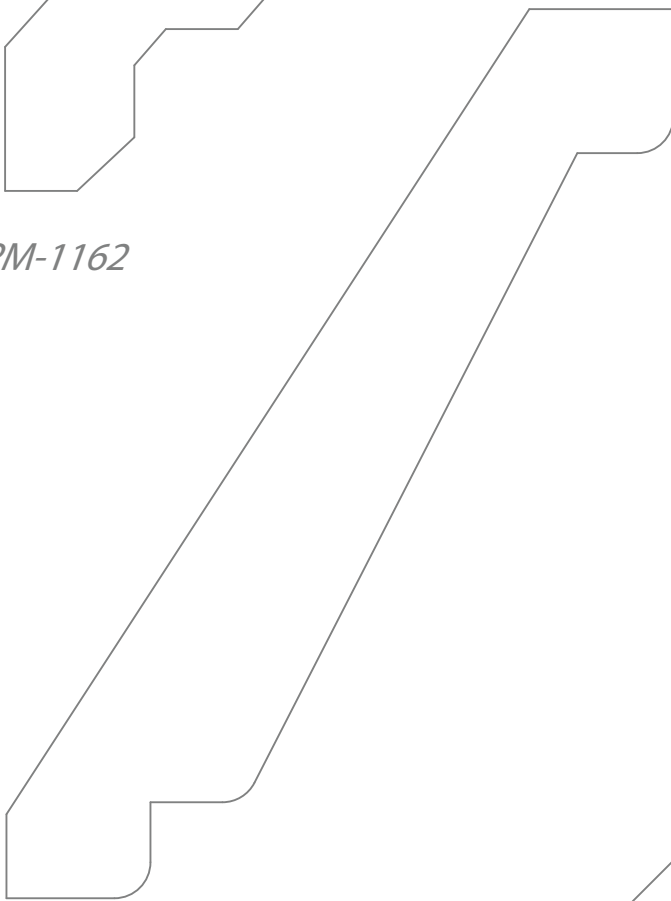

*PM-1183*

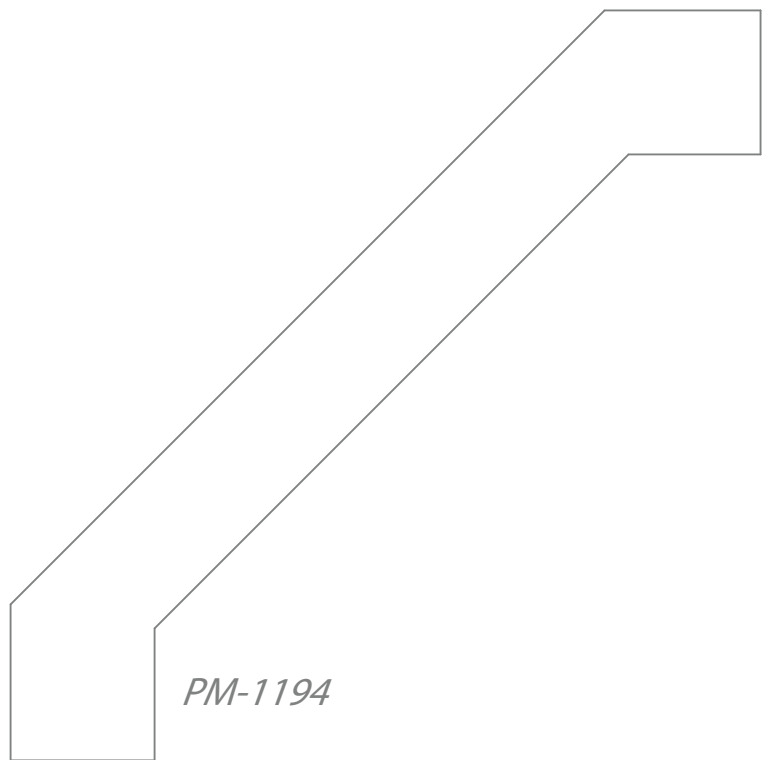

*PM-1194*

*PIERCE & PIERCE MILLWORK*

*FULL SCALE*

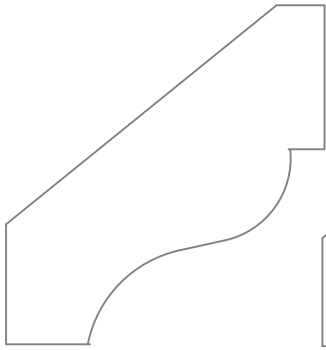

*PM-1177*

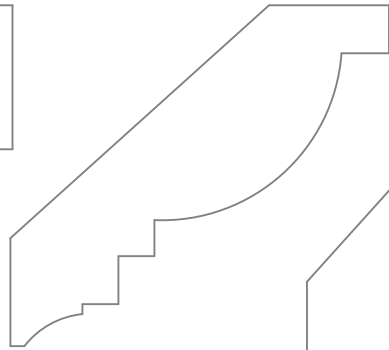

*PM-1181*

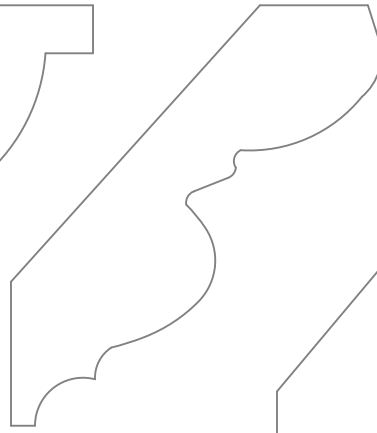

*PM-1167*

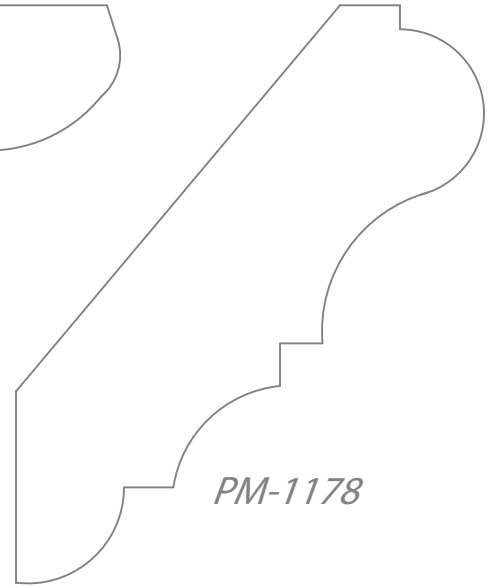

*PM-1178*

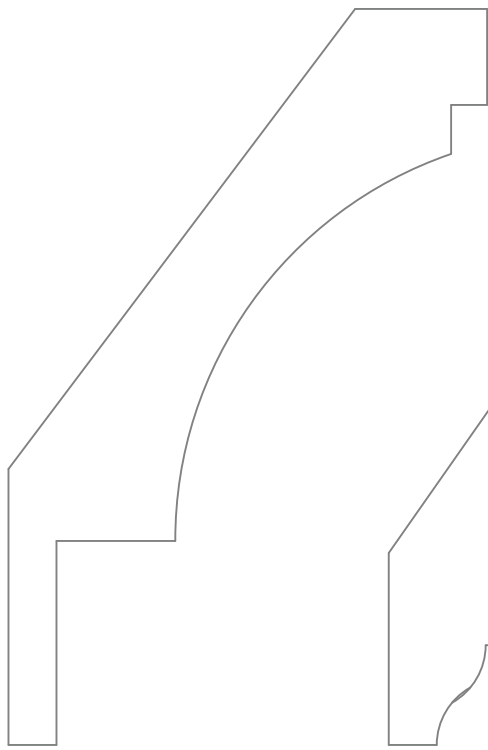

*PM-1188*

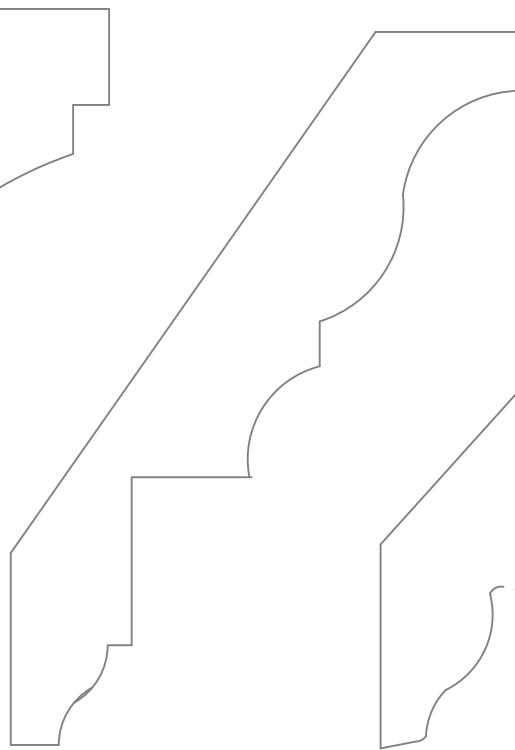

*PM-1195*

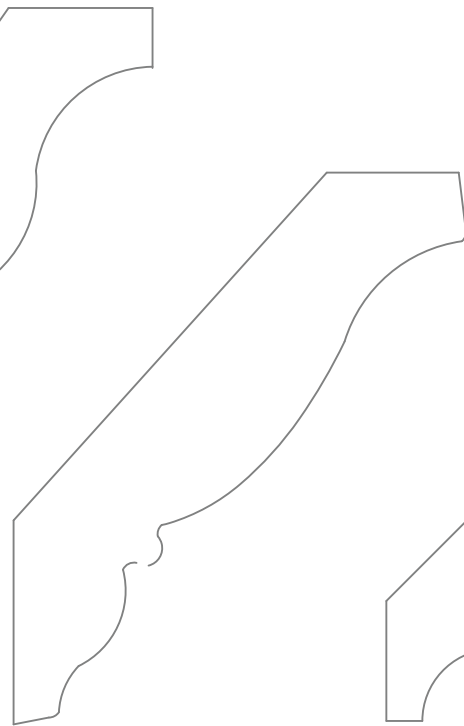

*PM-1184*

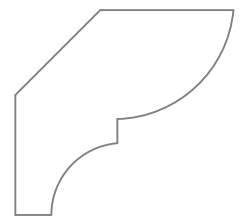

*PM-1186*



*PIERCE & PIERCE MILLWORK*

*FULL SCALE*

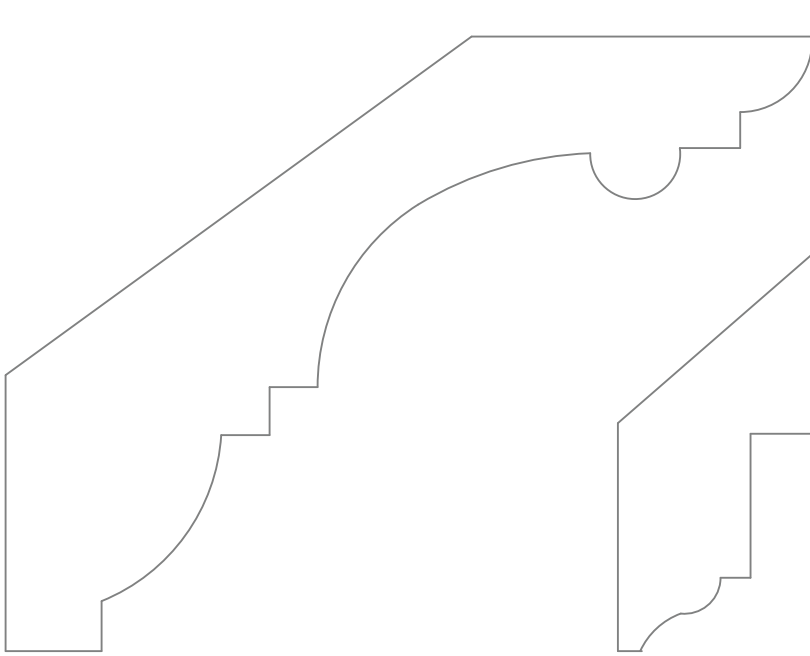

*PM-1189*

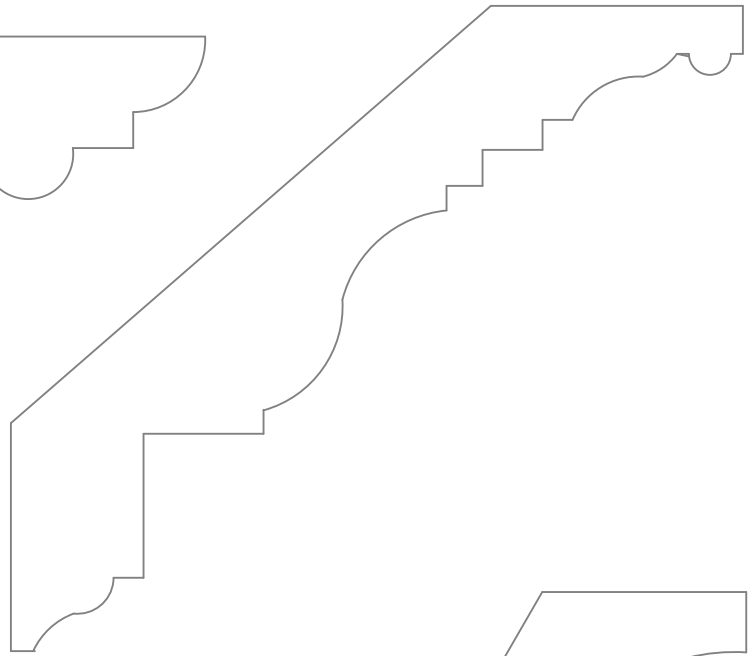

*PM-1190*

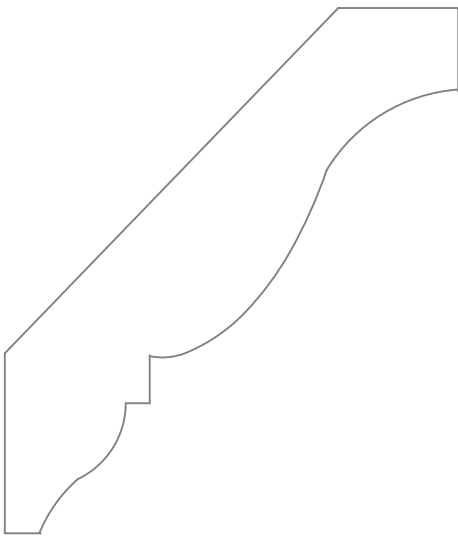

*PM-1191*

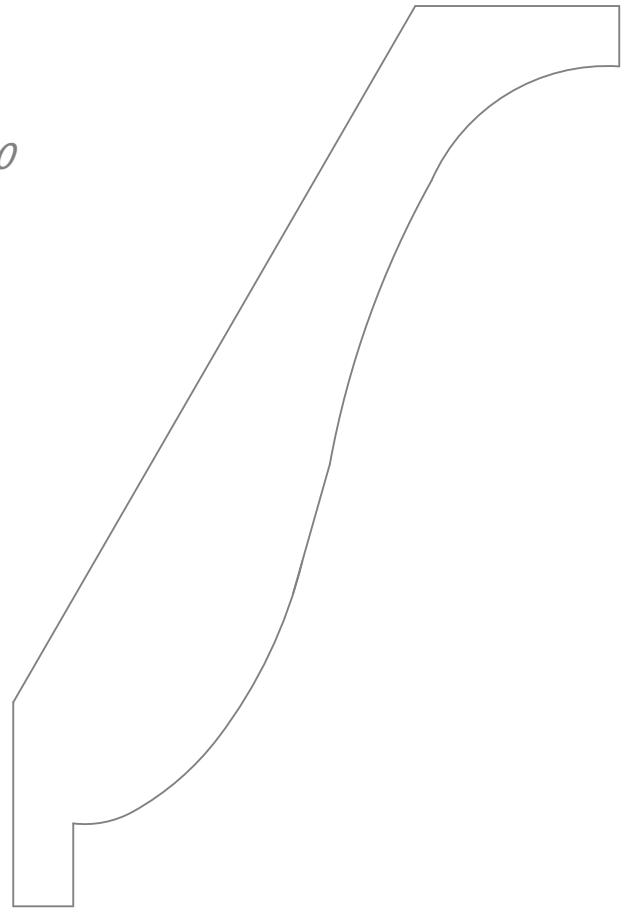

*PM-1199*

*PIERCE & PIERCE MILLWORK*

*FULL SCALE*

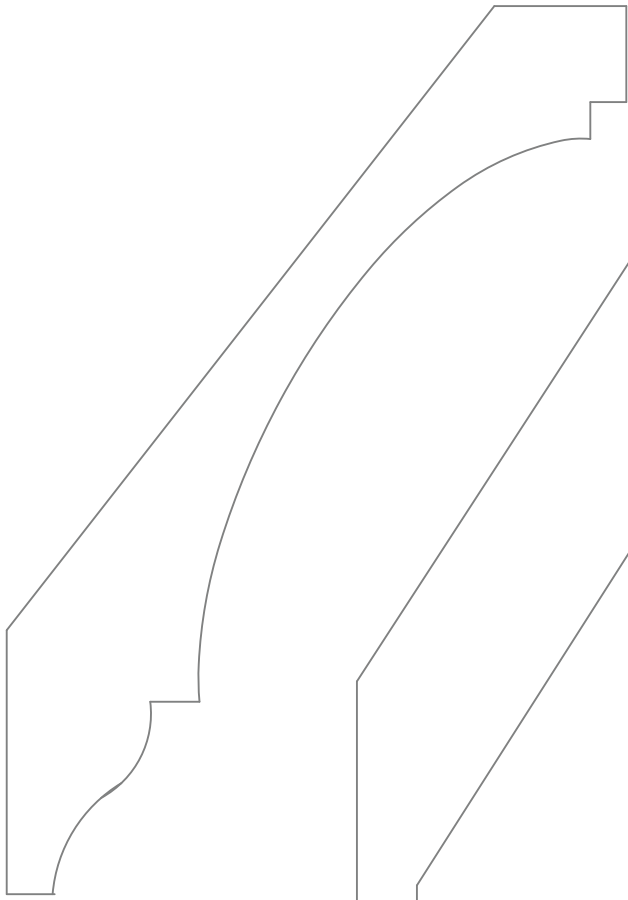

*PM-1204*

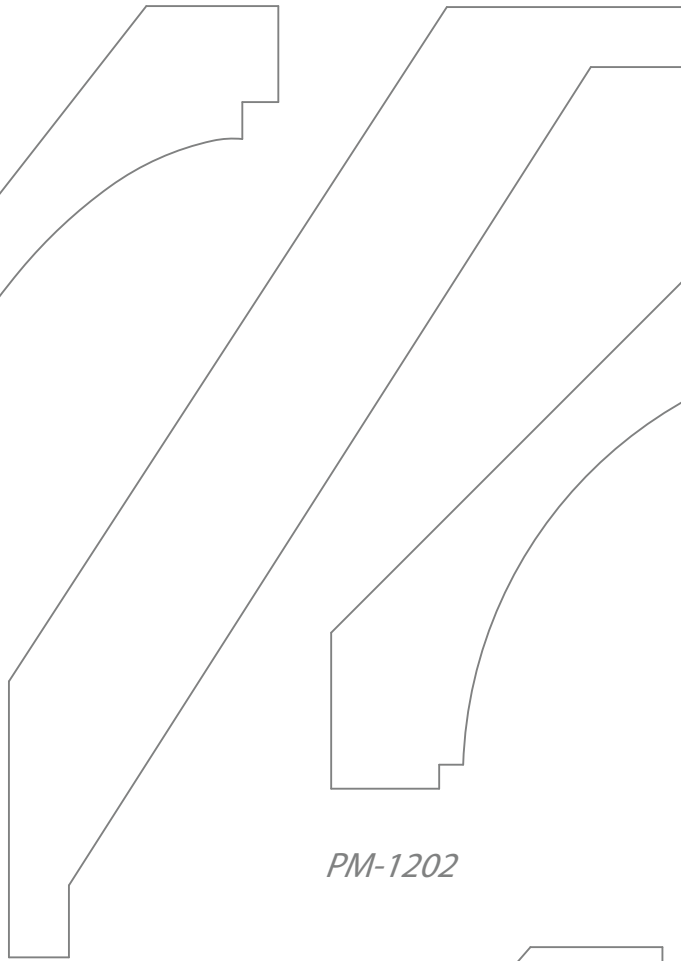

*PM-1200*

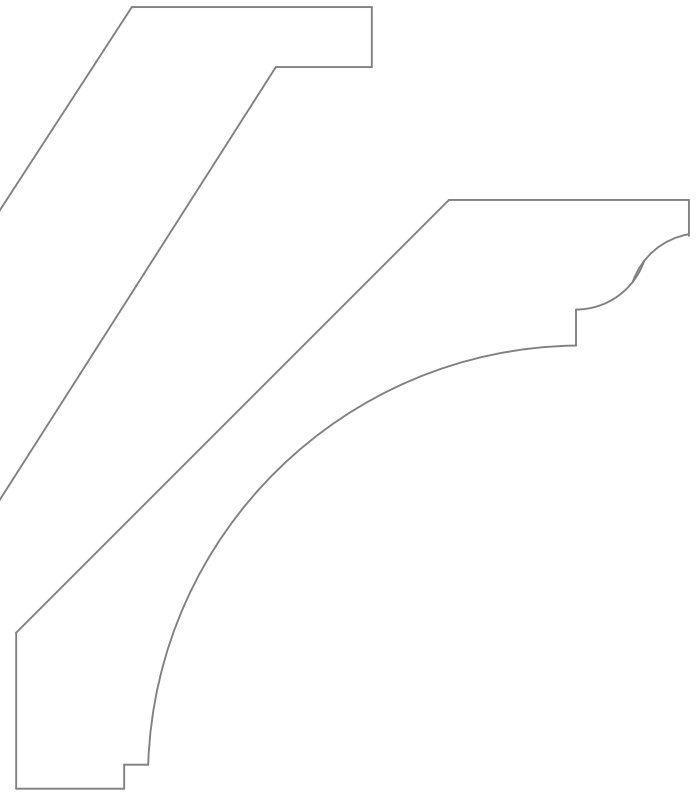

*PM-1202*

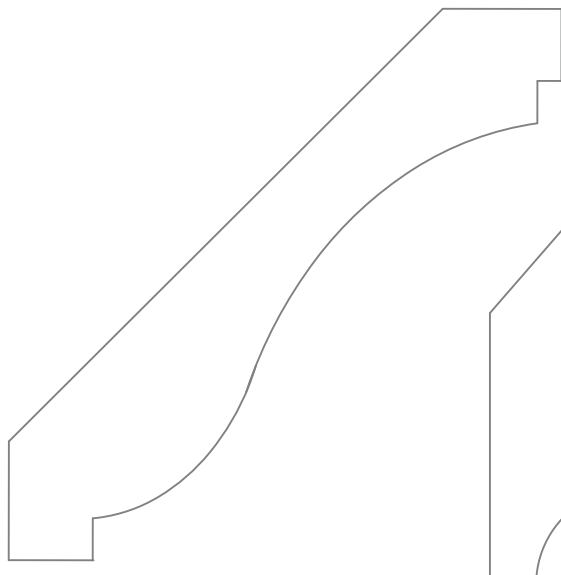

*PM-1207*

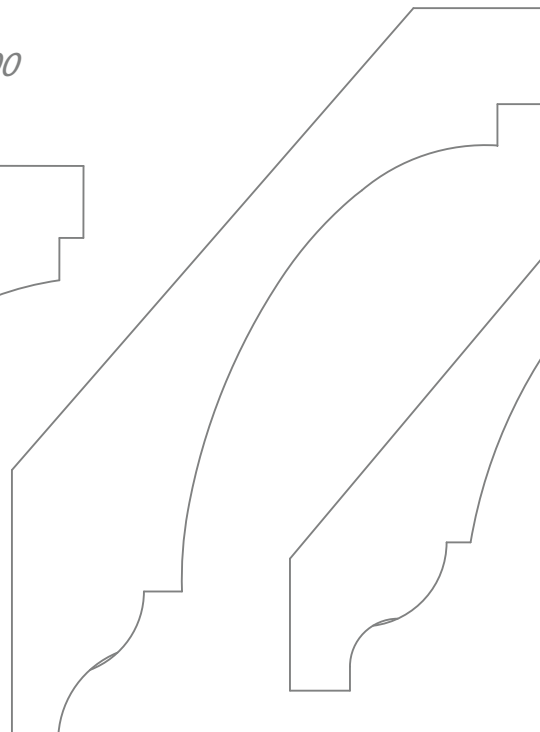

*PM-1205*

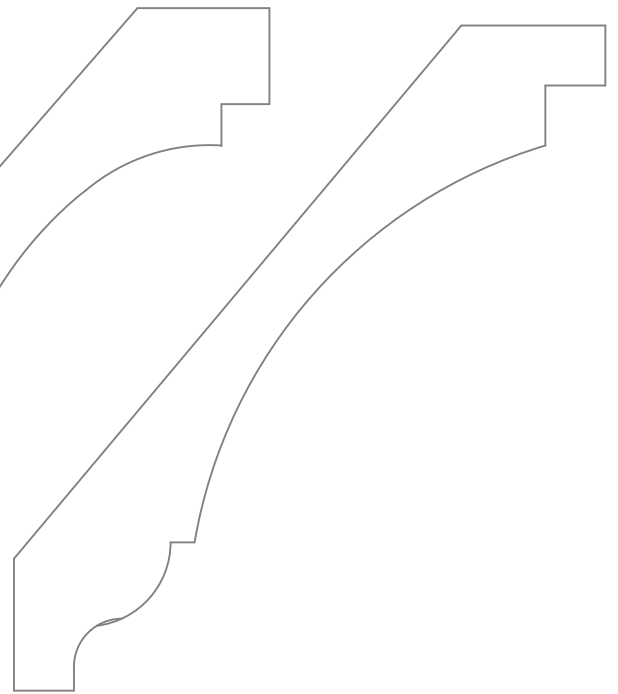

*PM-1206*

*PIERCE & PIERCE MILLWORK*

*FULL SCALE*

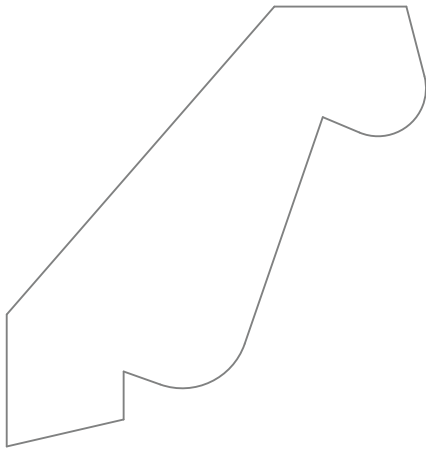

*PM-1236*

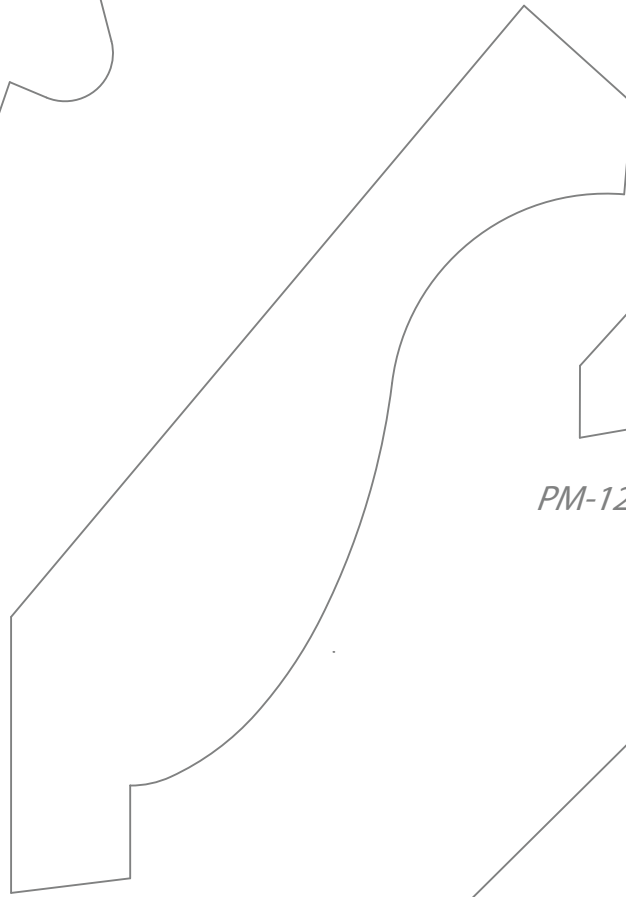

*PM-1239*

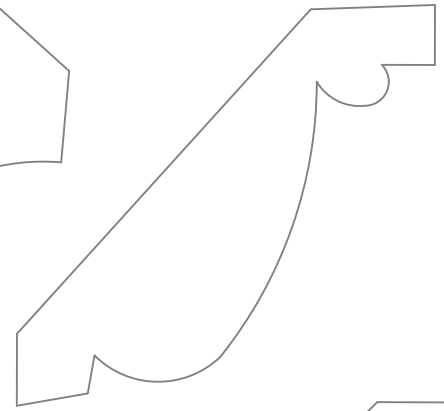

*PM-1288*

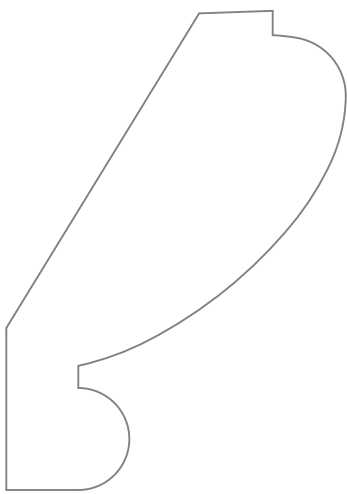

*PM-1299*

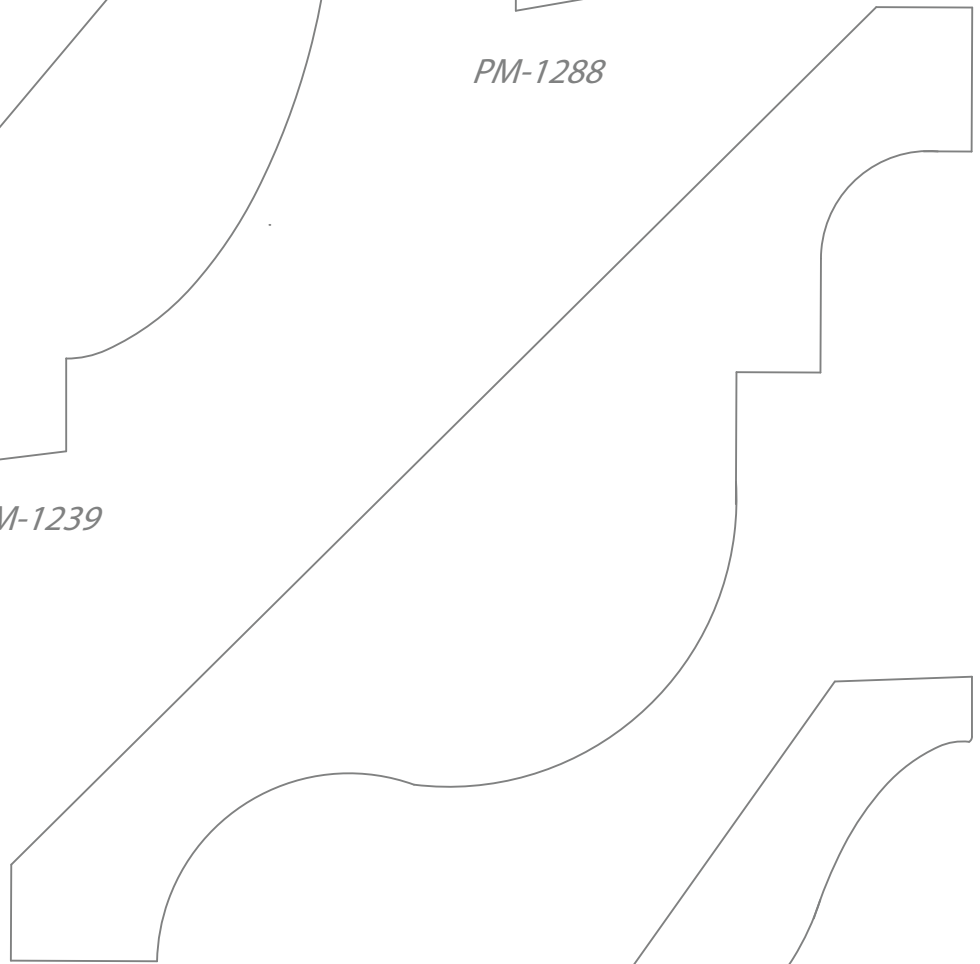

*PM-1208*

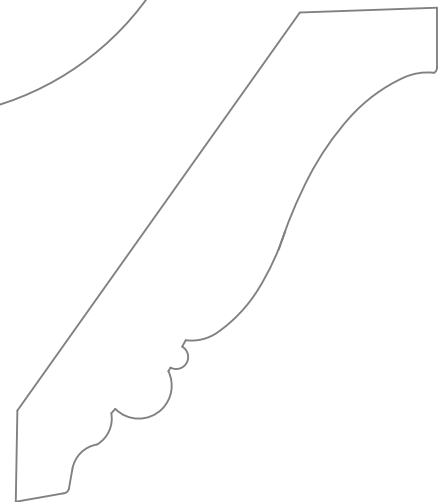

*PM-1209E*

*PIERCE & PIERCE MILLWORK*

*FULL SCALE*

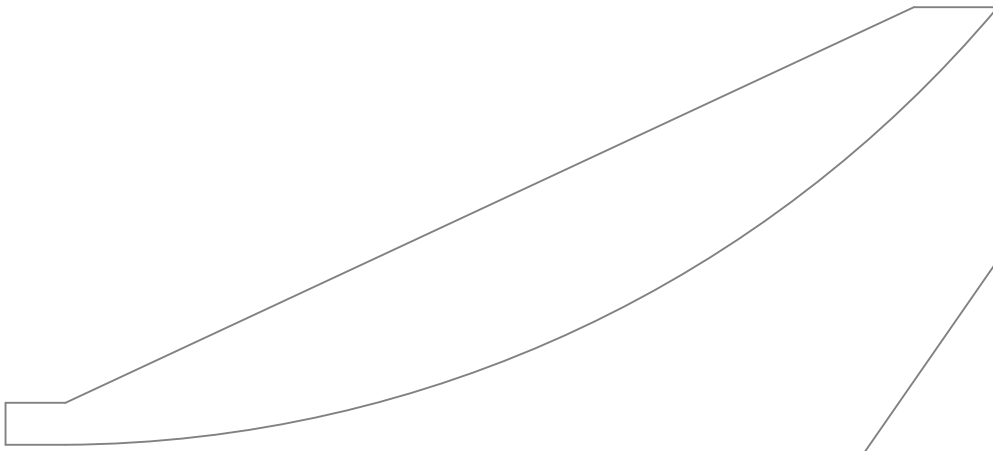

*PM-1213*

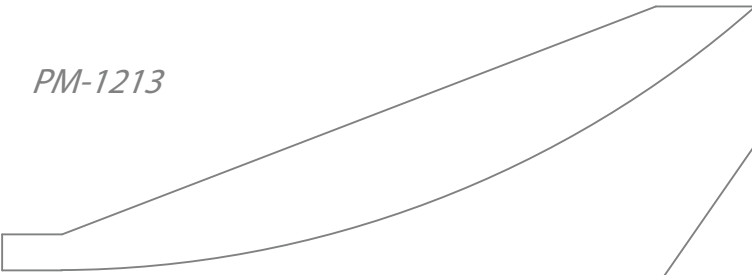

*PM-1212*

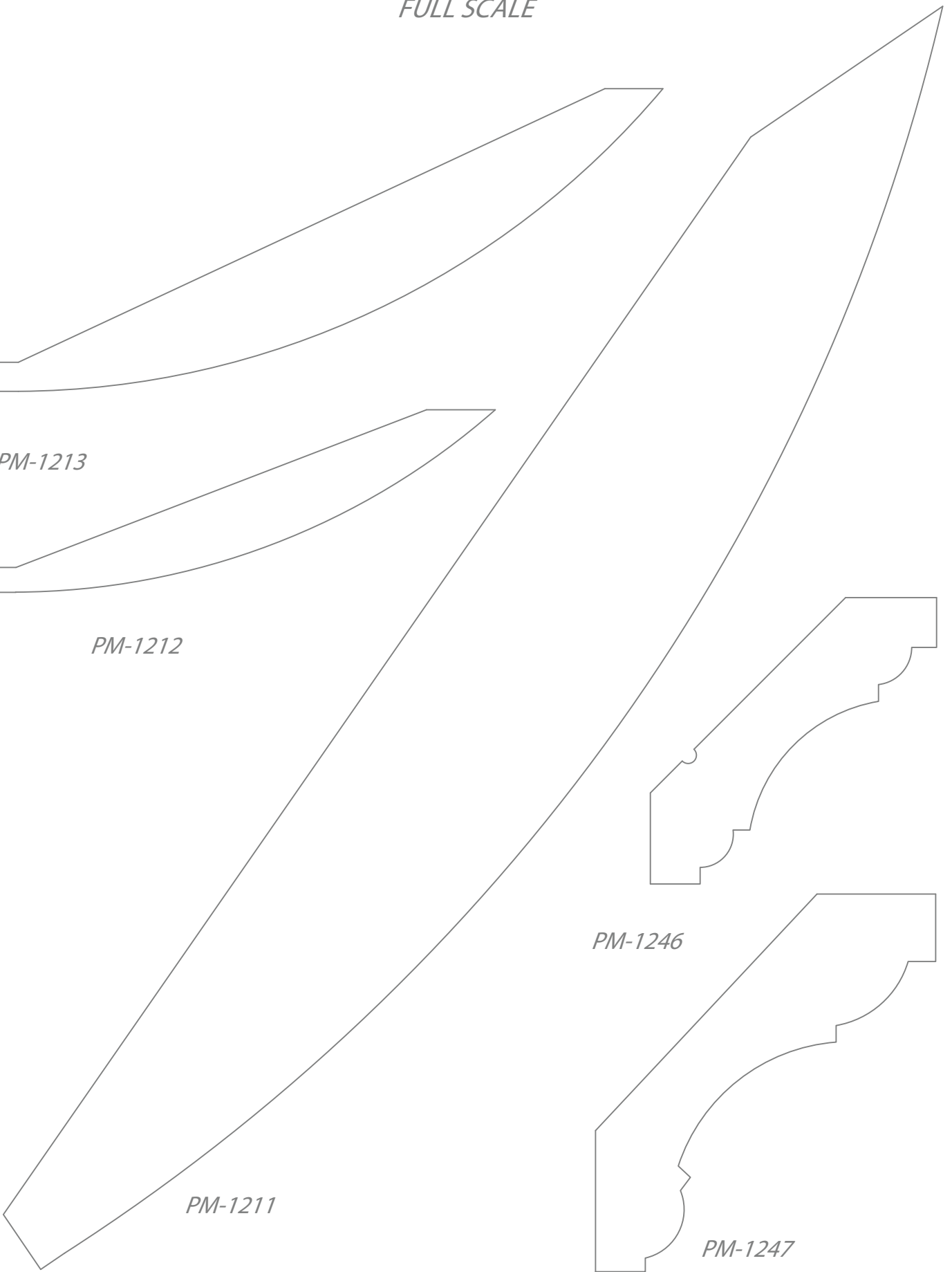

*PM-1211*

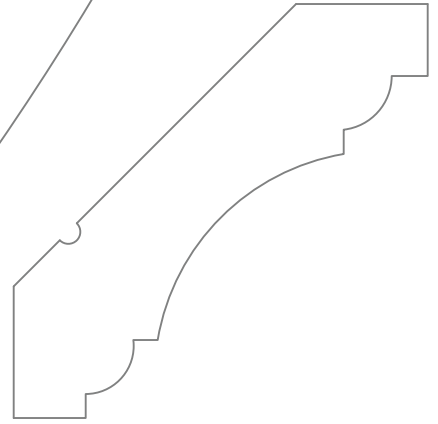

*PM-1246*

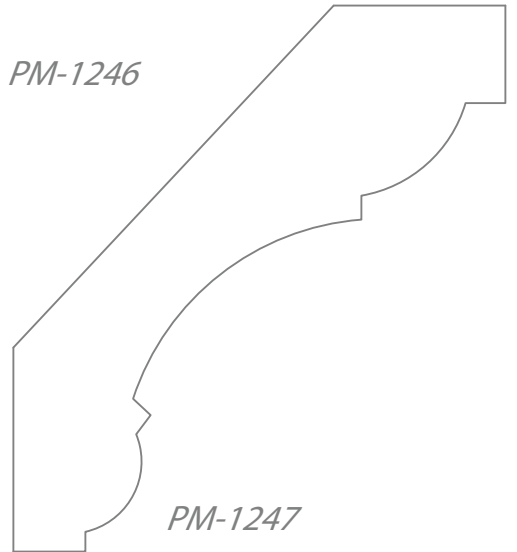

*PM-1247*

*PIERCE & PIERCE MILLWORK*

*FULL SCALE*

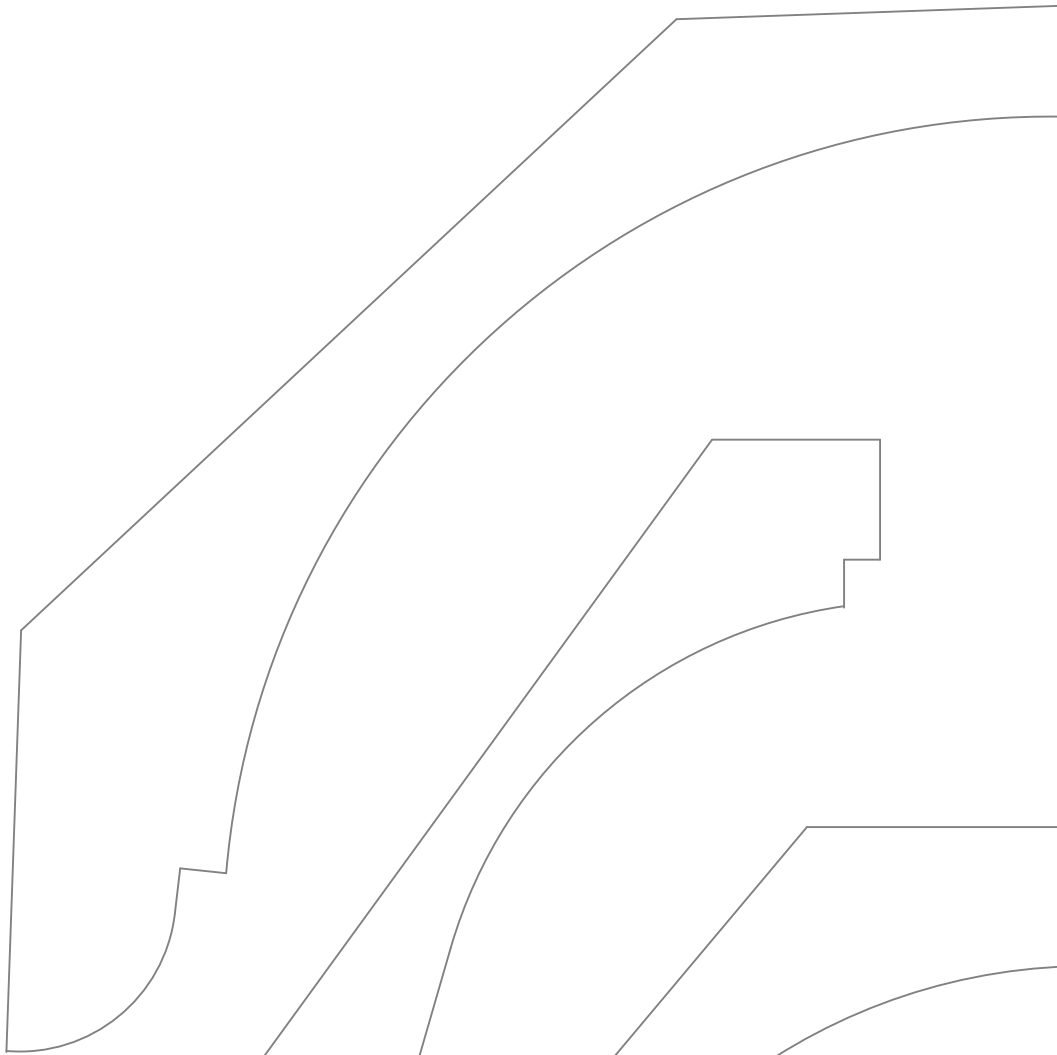

*PM-1221*

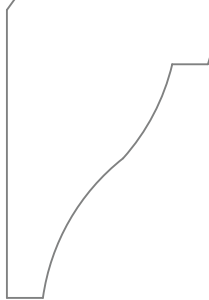

*PM-1214*

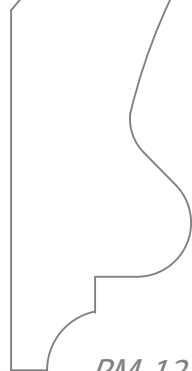

*PM-1215*

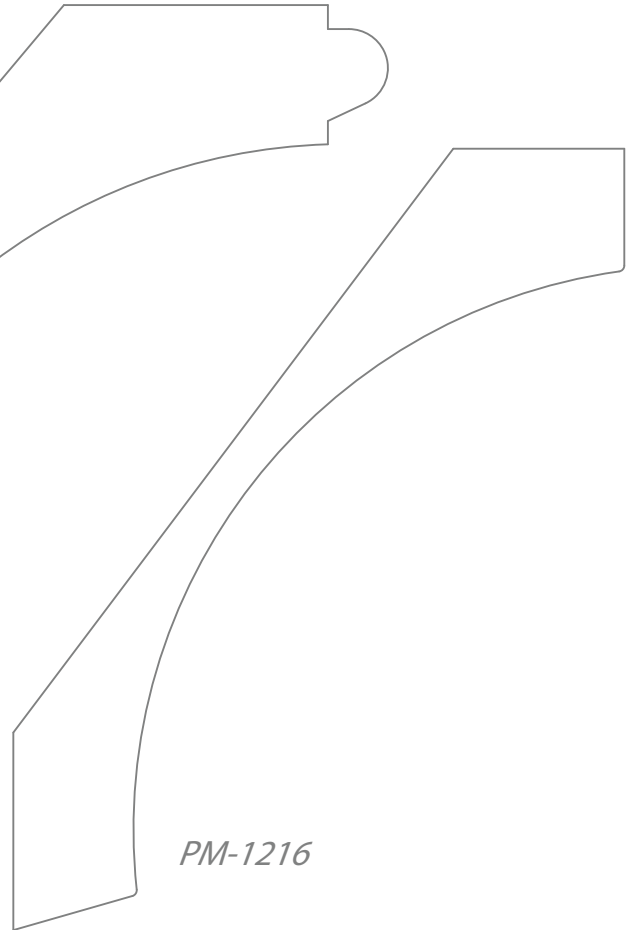

*PM-1216*

*PIERCE & PIERCE MILLWORK*

*FULL SCALE*

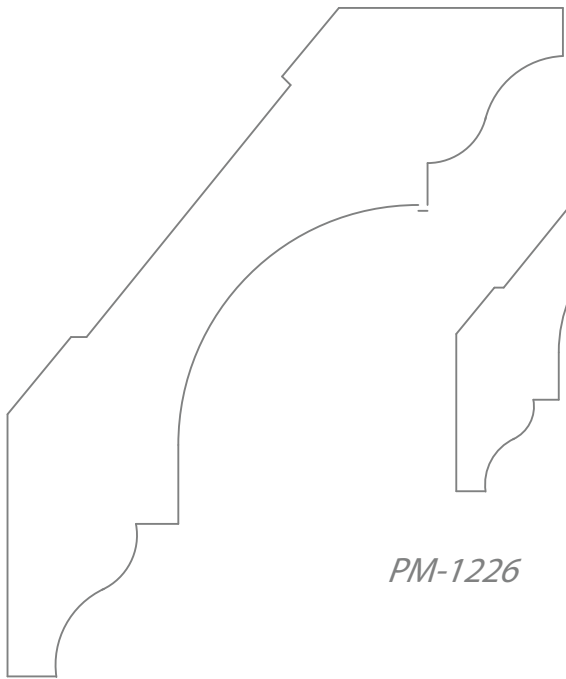

*PM-1226*

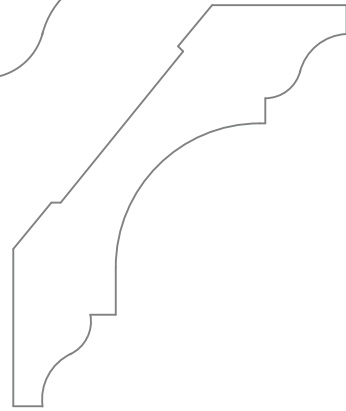

*PM-1222*

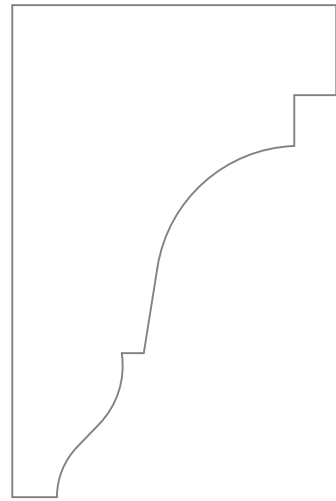

*PM-1227*

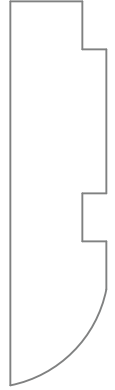

*PM-1217*

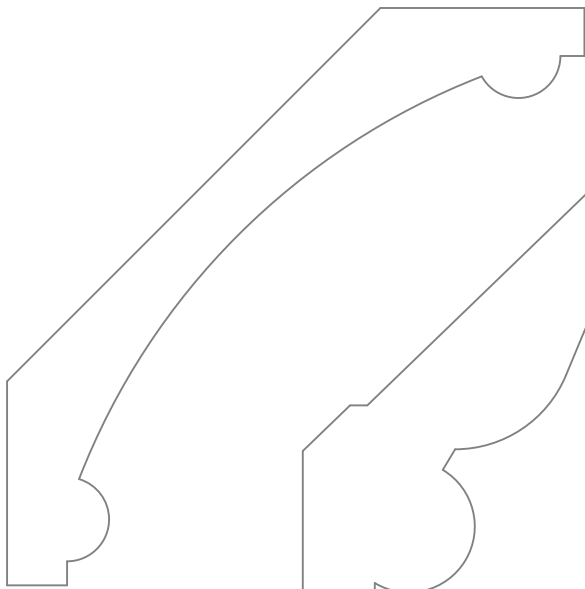

*PM-1230*

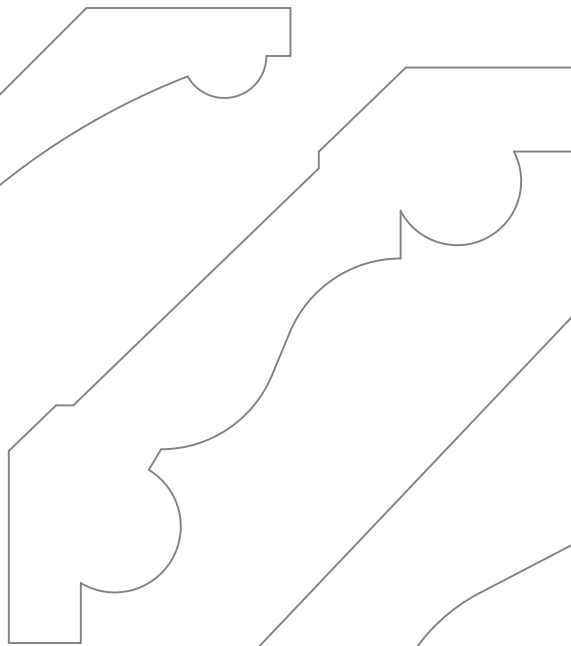

*PM-1234*

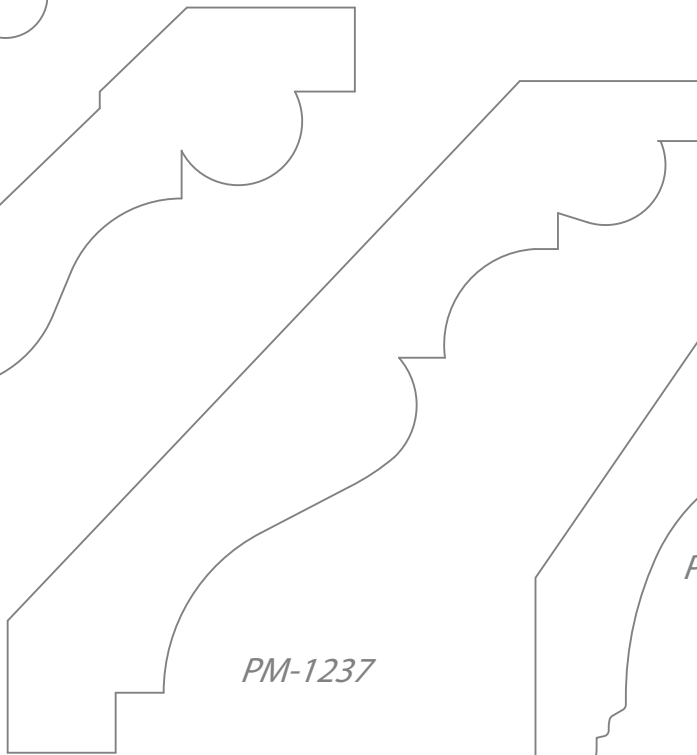

*PM-1237*

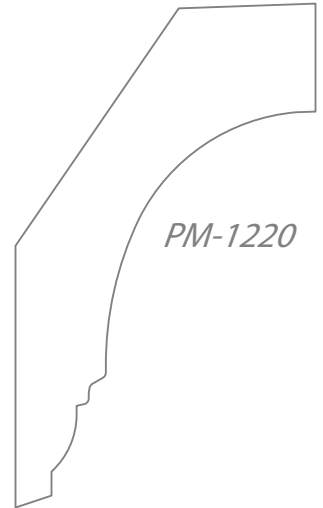

*PM-1220*

*PIERCE & PIERCE MILLWORK*

*FULL SCALE*

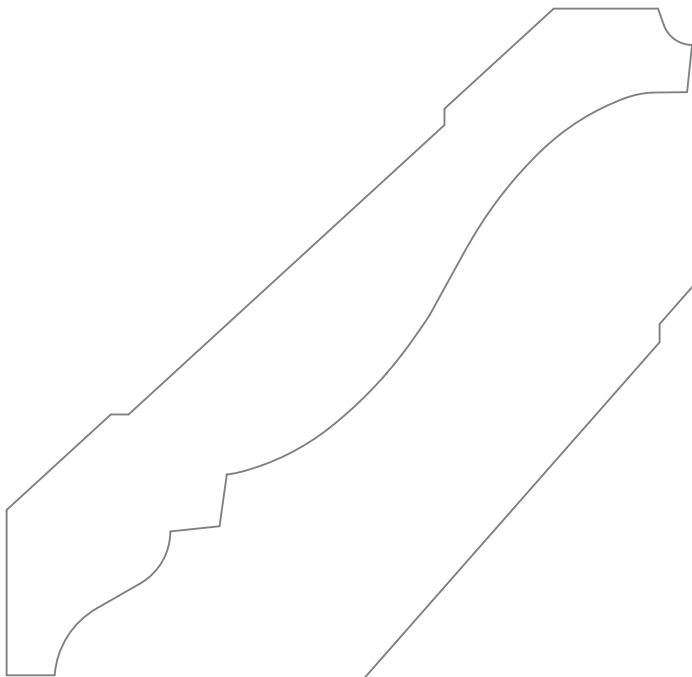

*PM-1248*

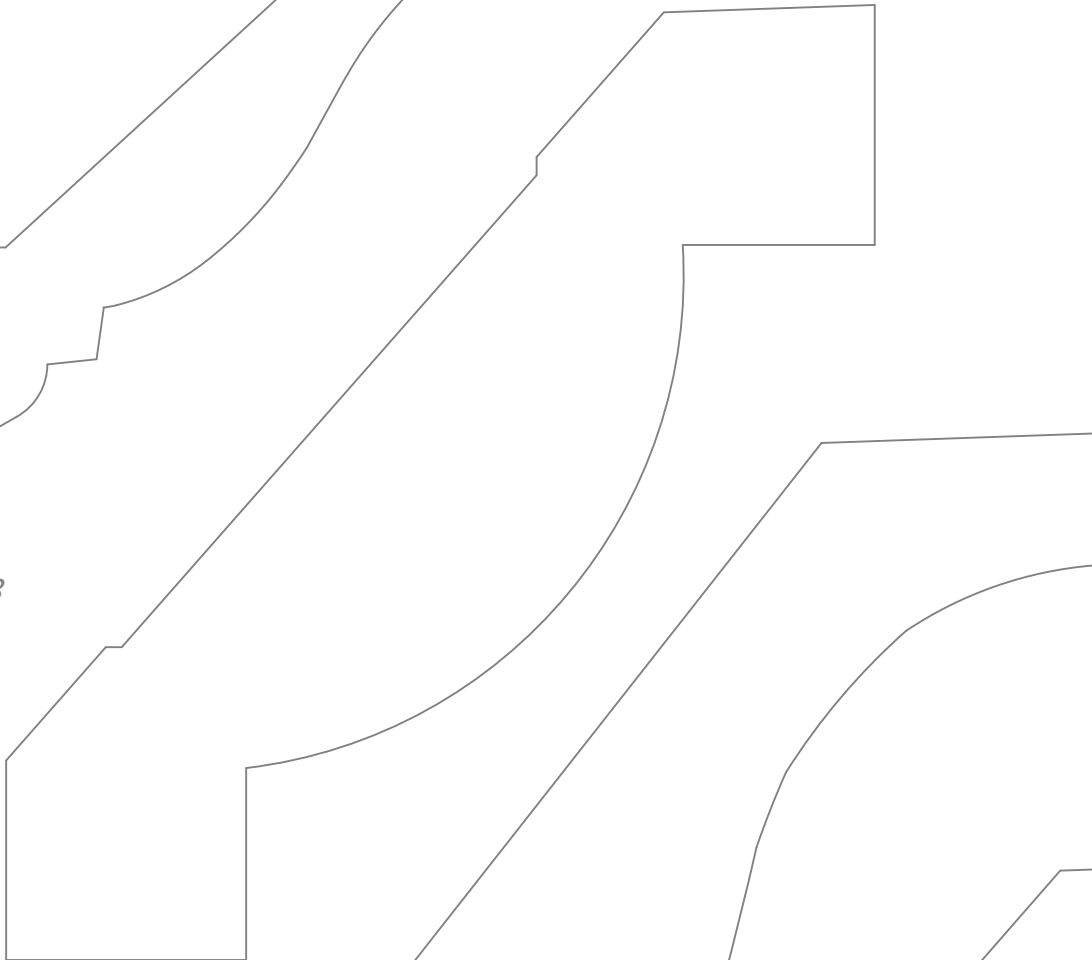

*PM-1265*



*PM-1284*

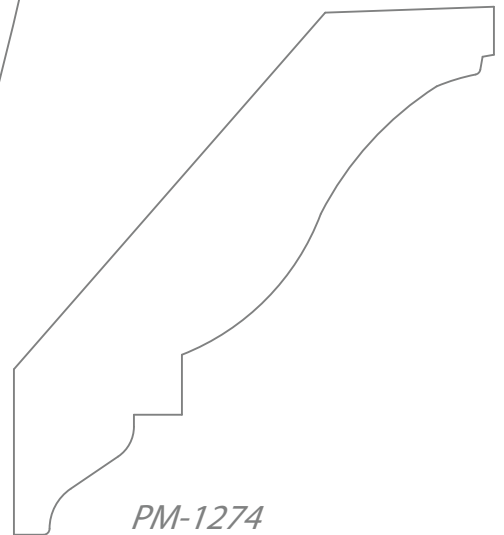

*PM-1274*

*PIERCE & PIERCE MILLWORK*

*FULL SCALE*

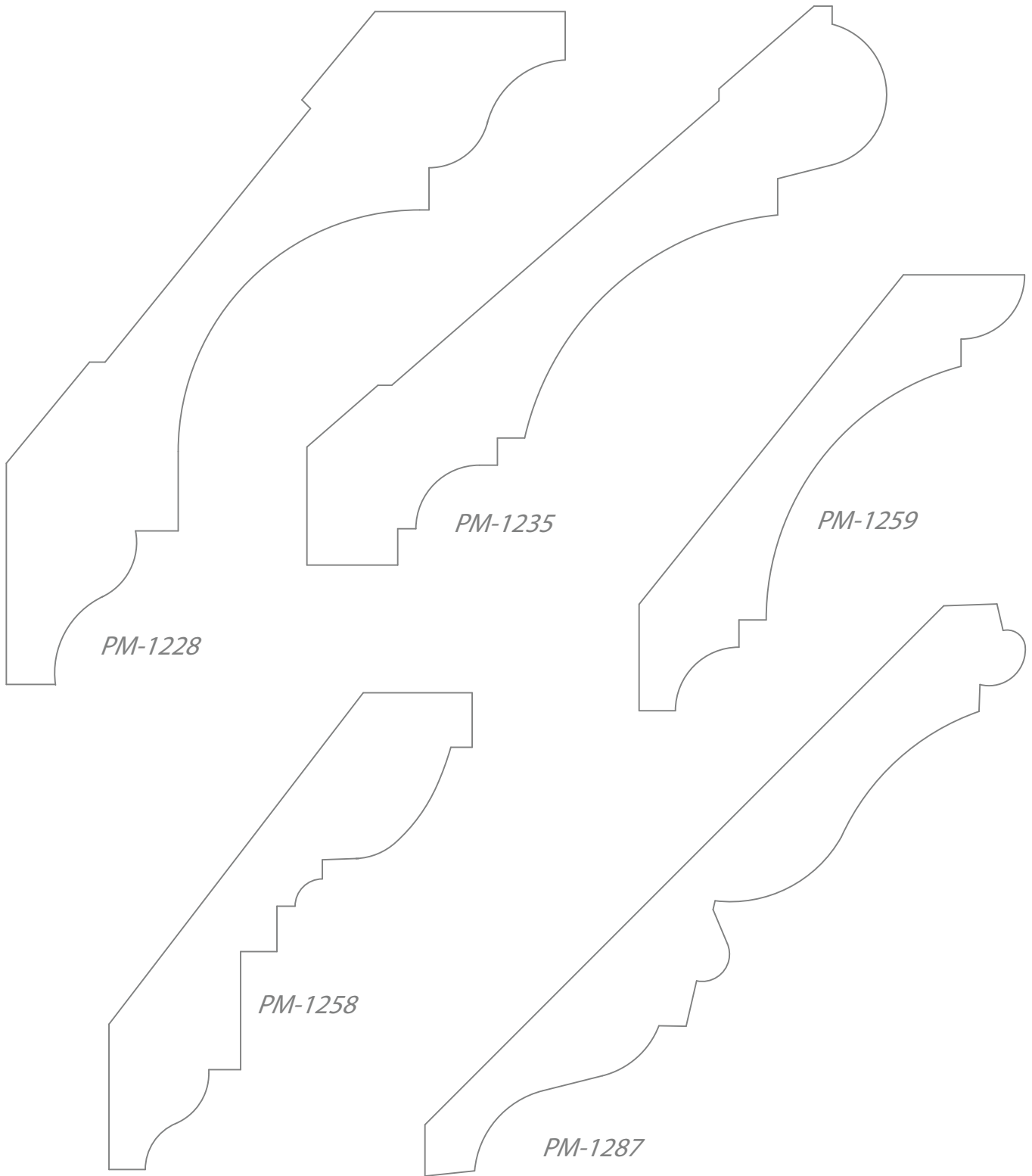



*PIERCE & PIERCE MILLWORK*

*FULL SCALE*

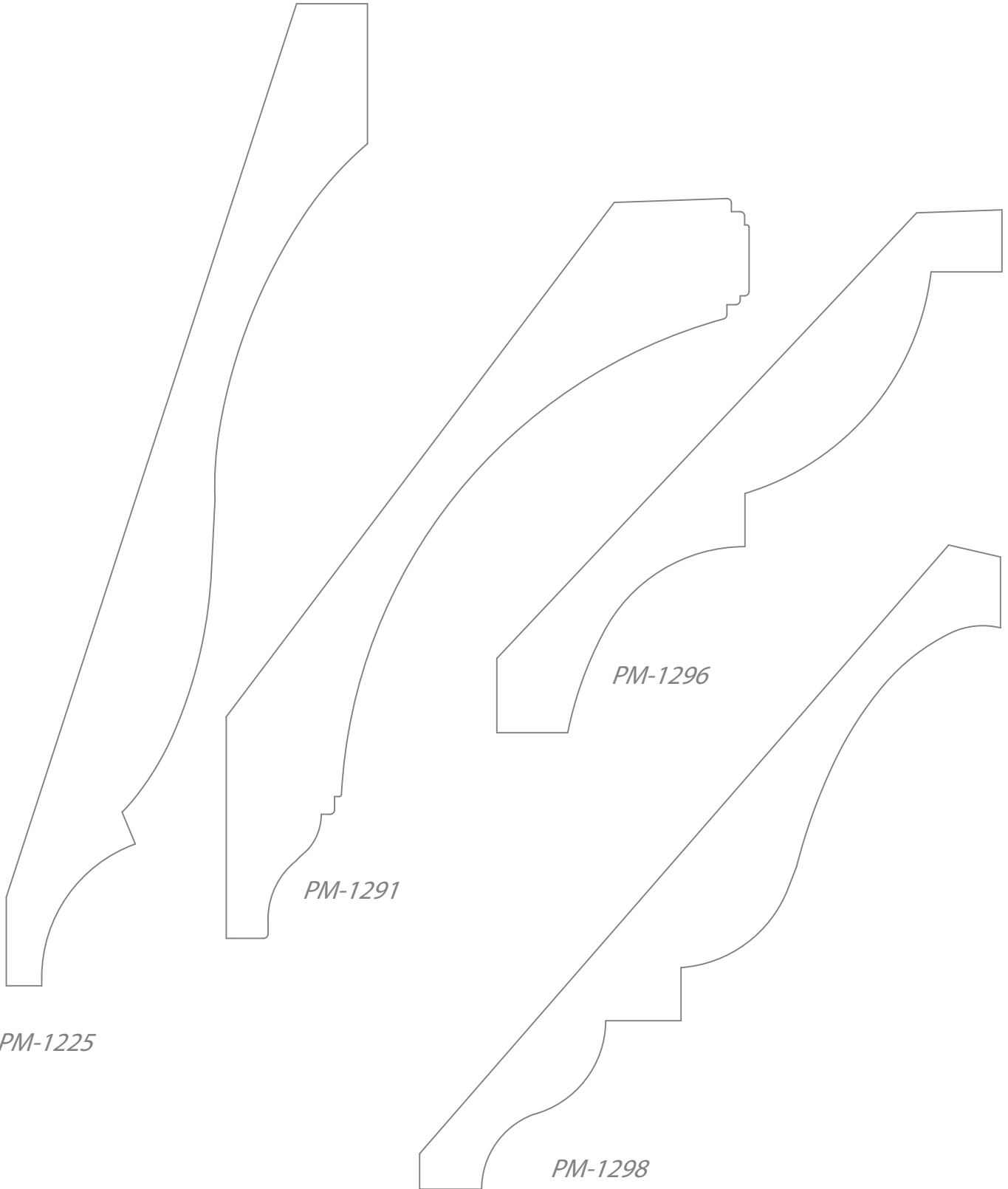

*PM-1225*

*PM-1291*

*PM-1296*

*PM-1298*

*PIERCE & PIERCE MILLWORK*

*FULL SCALE*

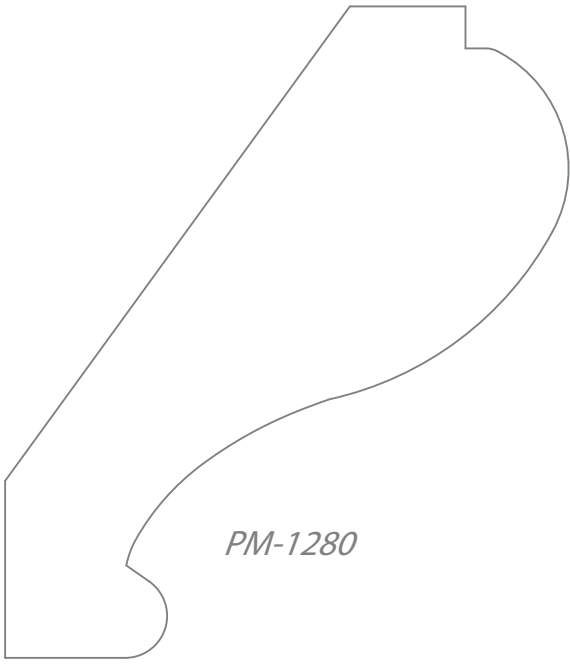

*PM-1280*

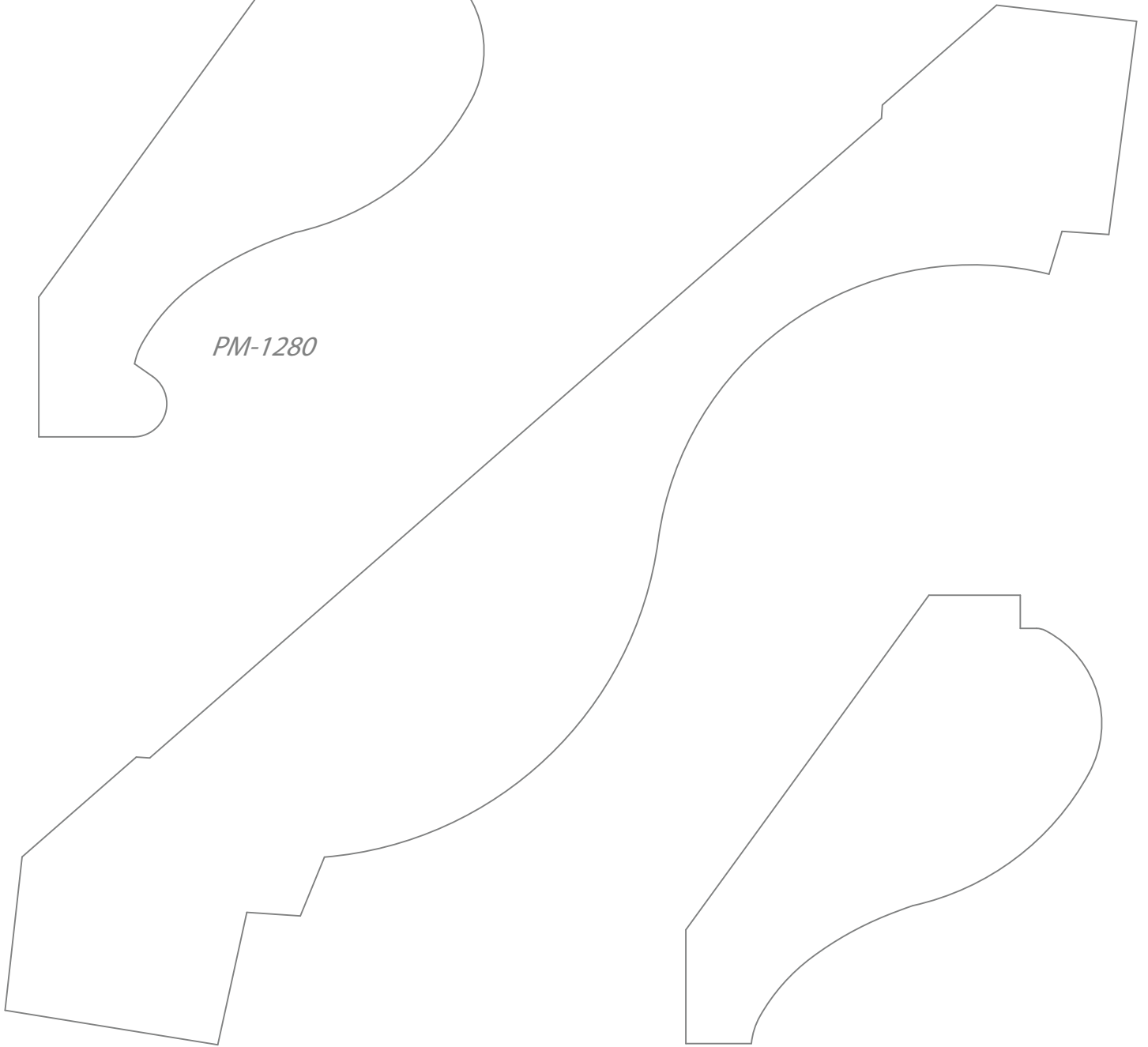

*PM-1238*

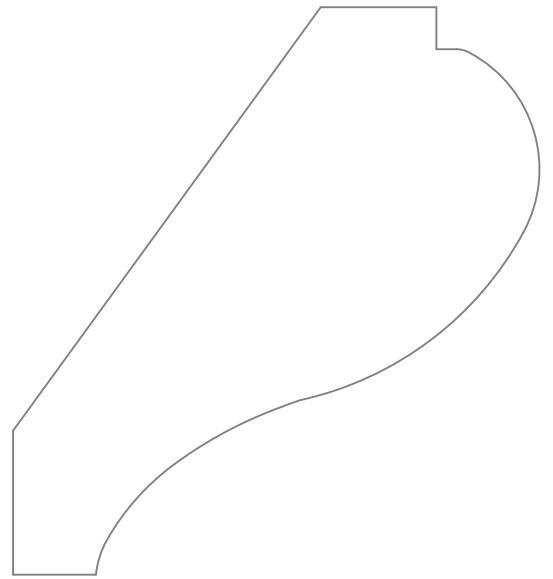

*PM-1278*

*PIERCE & PIERCE MILLWORK*

*FULL SCALE*

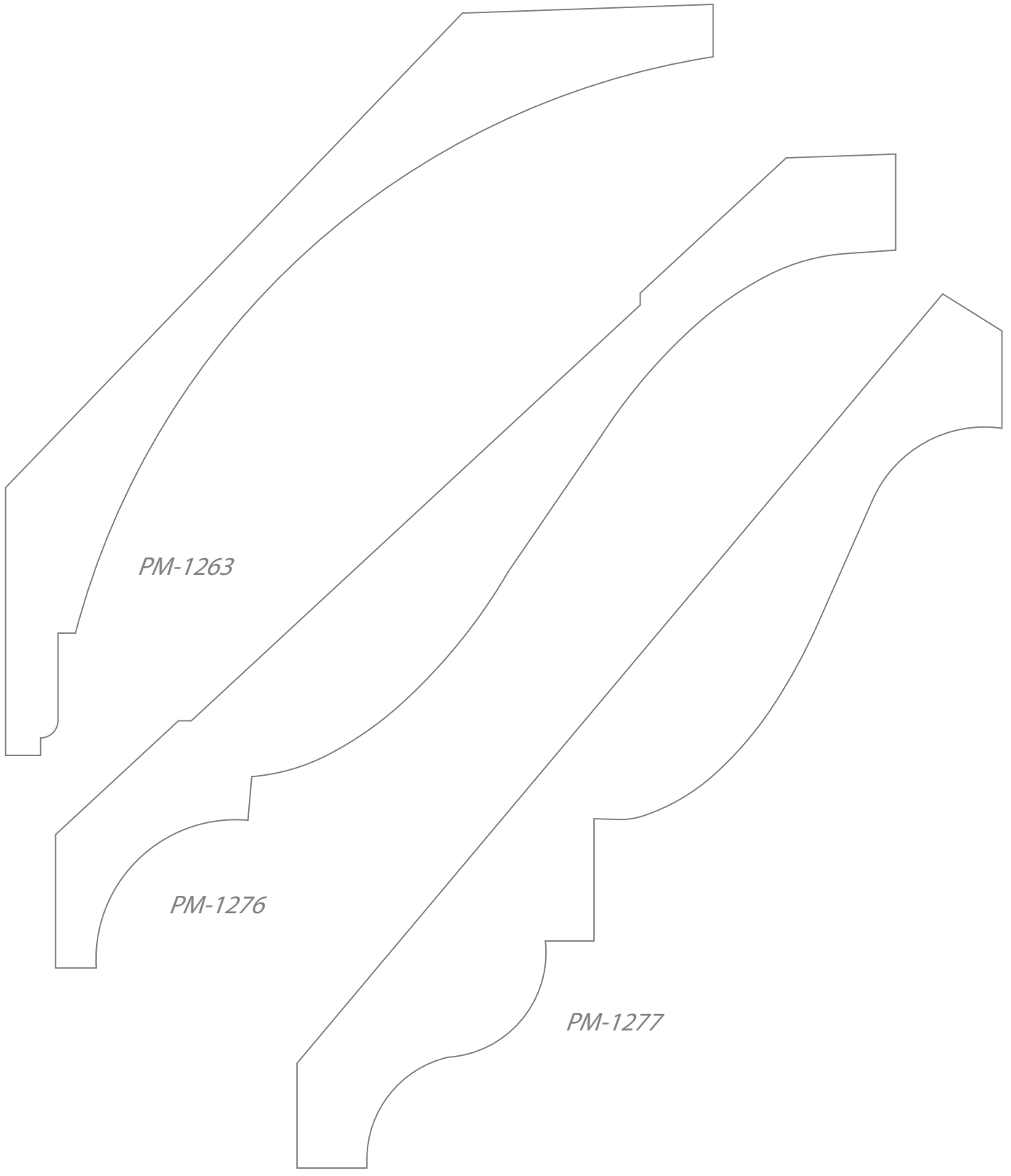

*PM-1263*

*PM-1276*

*PM-1277*

*PIERCE & PIERCE MILLWORK*

*FULL SCALE*



*PM-1281*

*PM-1295*

*PIERCE & PIERCE MILLWORK*

*FULL SCALE*

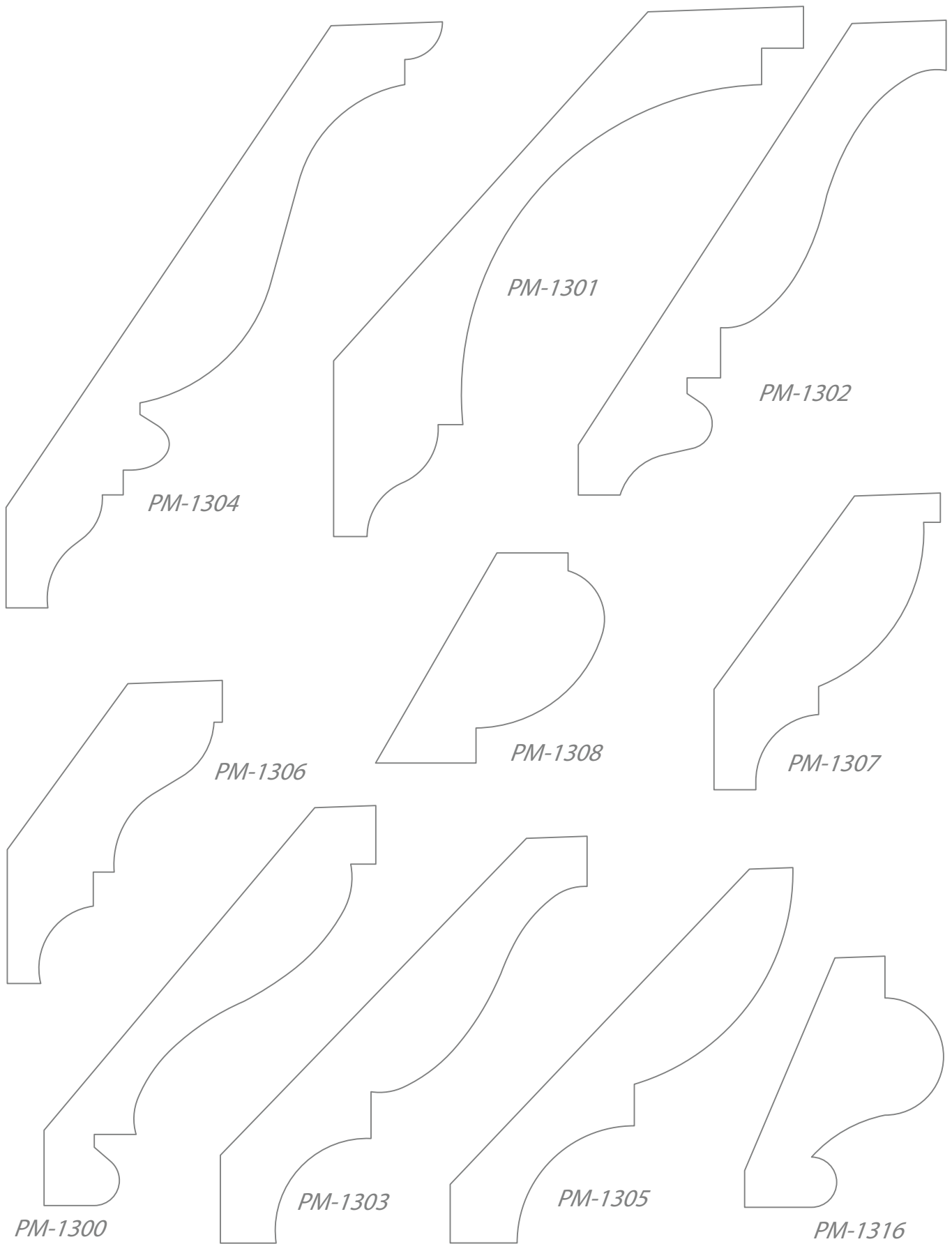

*PIERCE & PIERCE MILLWORK*

*FULL SCALE*

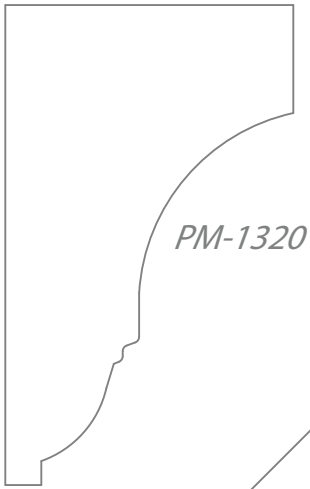

*PM-1320*

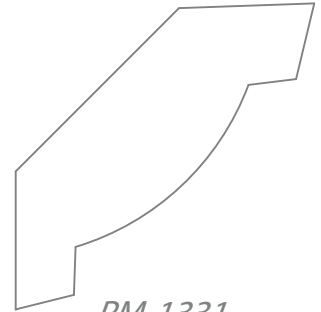

*PM-1331*



*PM-1314*

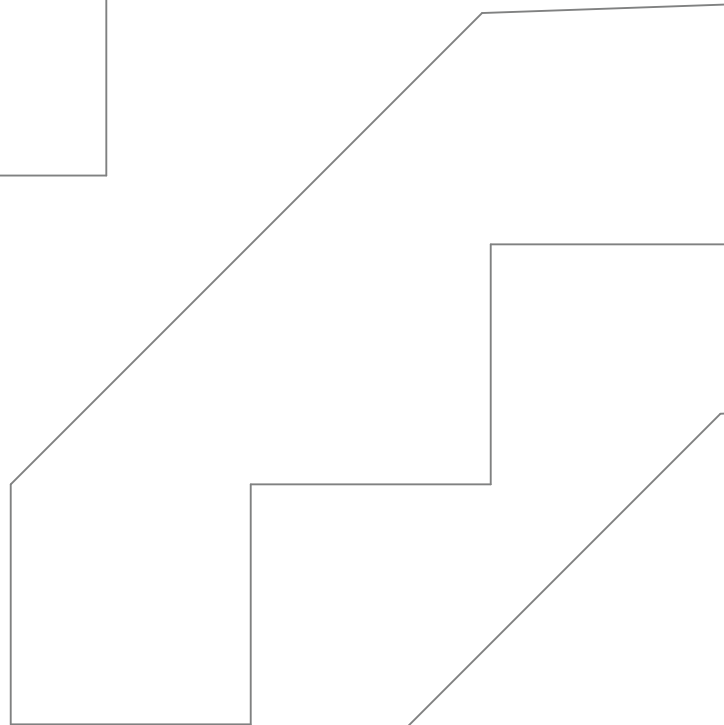

*PM-1313*

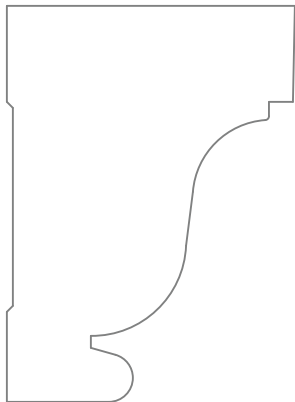

*PM-1344*

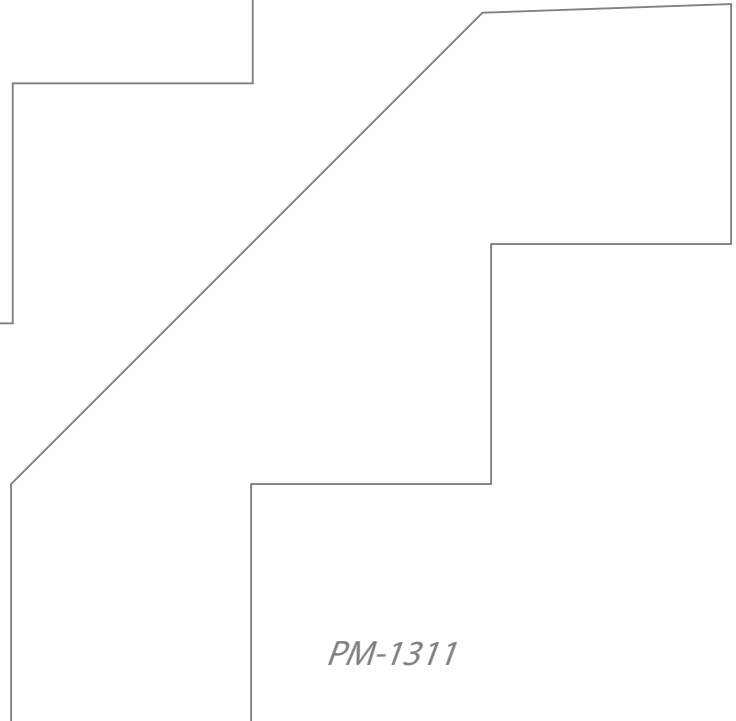

*PM-1311*

*PIERCE & PIERCE MILLWORK*

*FULL SCALE*

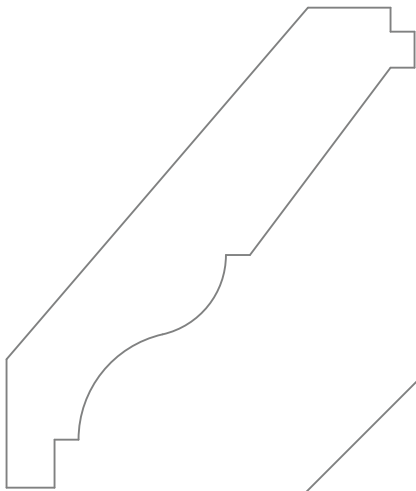

*PM-1310*

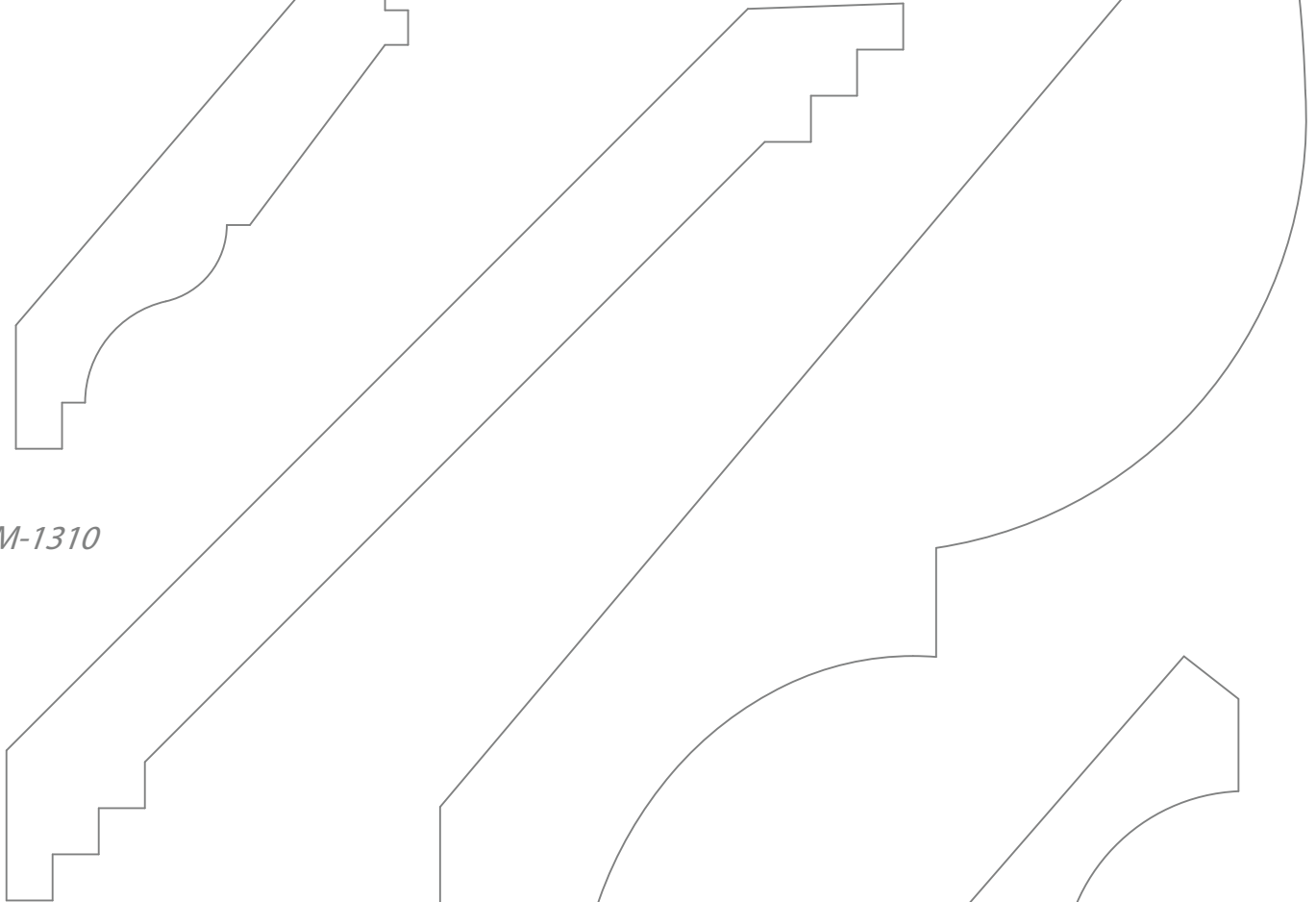

*PM-1312*

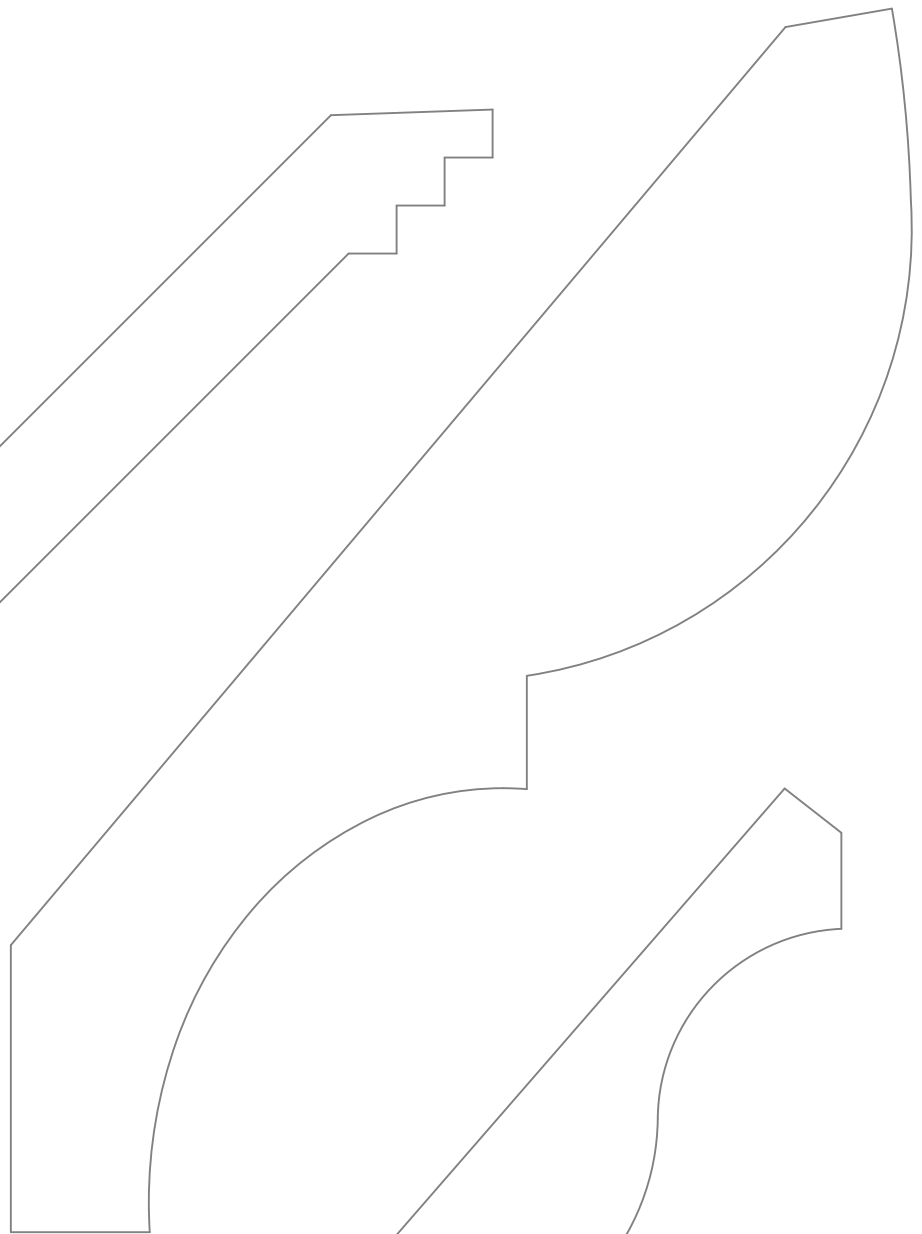

*PM-1333*

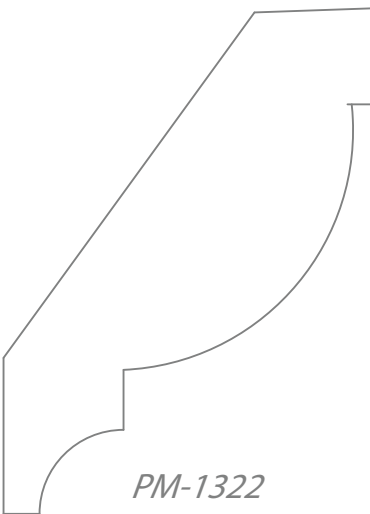

*PM-1322*

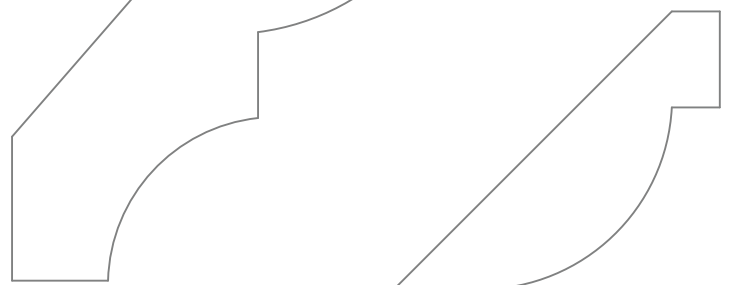

*PM-1315*

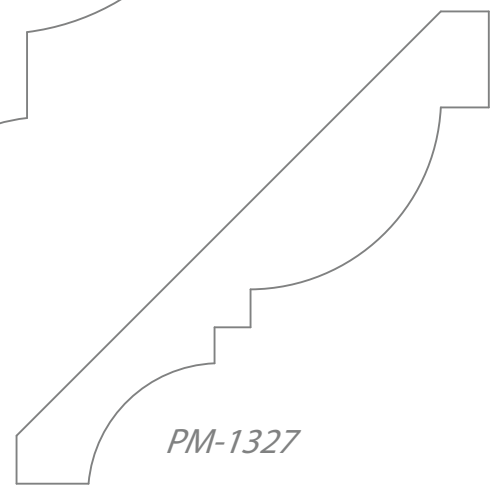

*PM-1327*

*PIERCE & PIERCE MILLWORK*

*FULL SCALE*

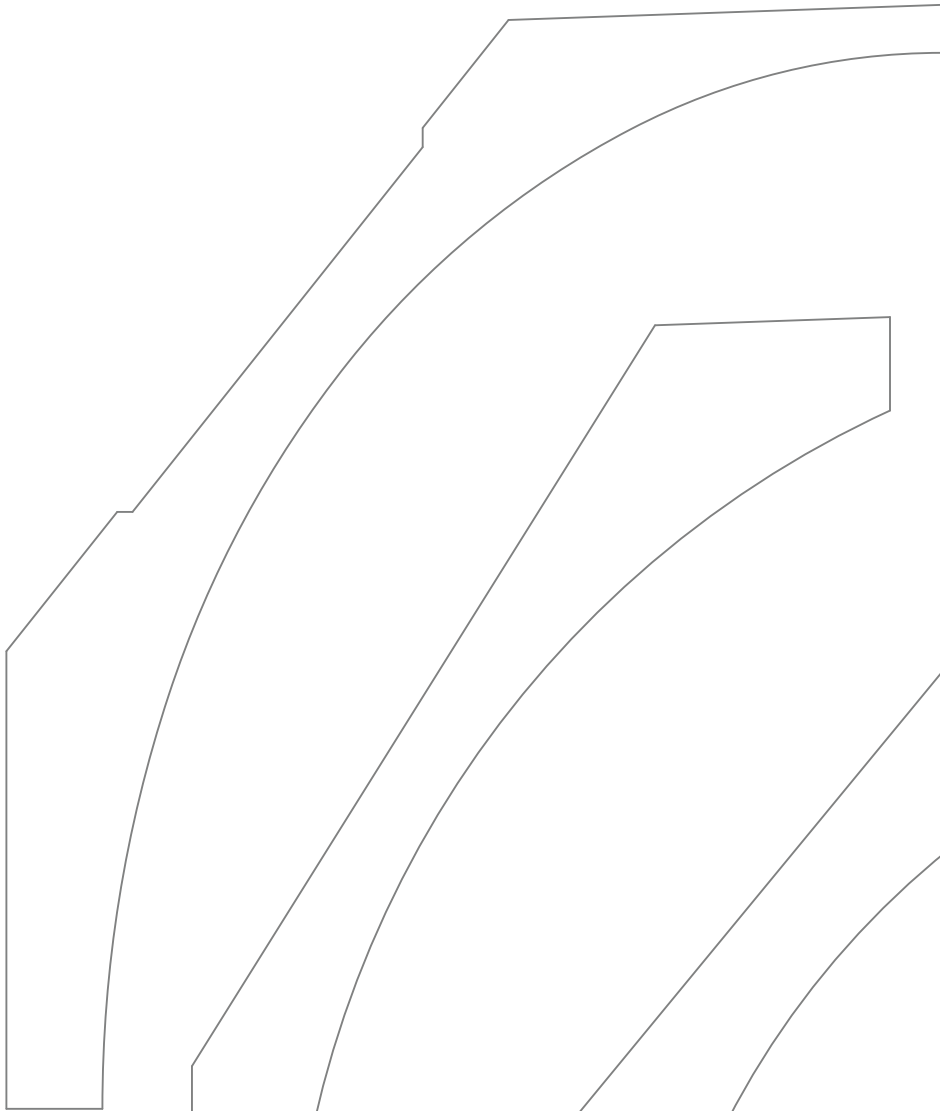

*PM-1326*



*PM-1317*

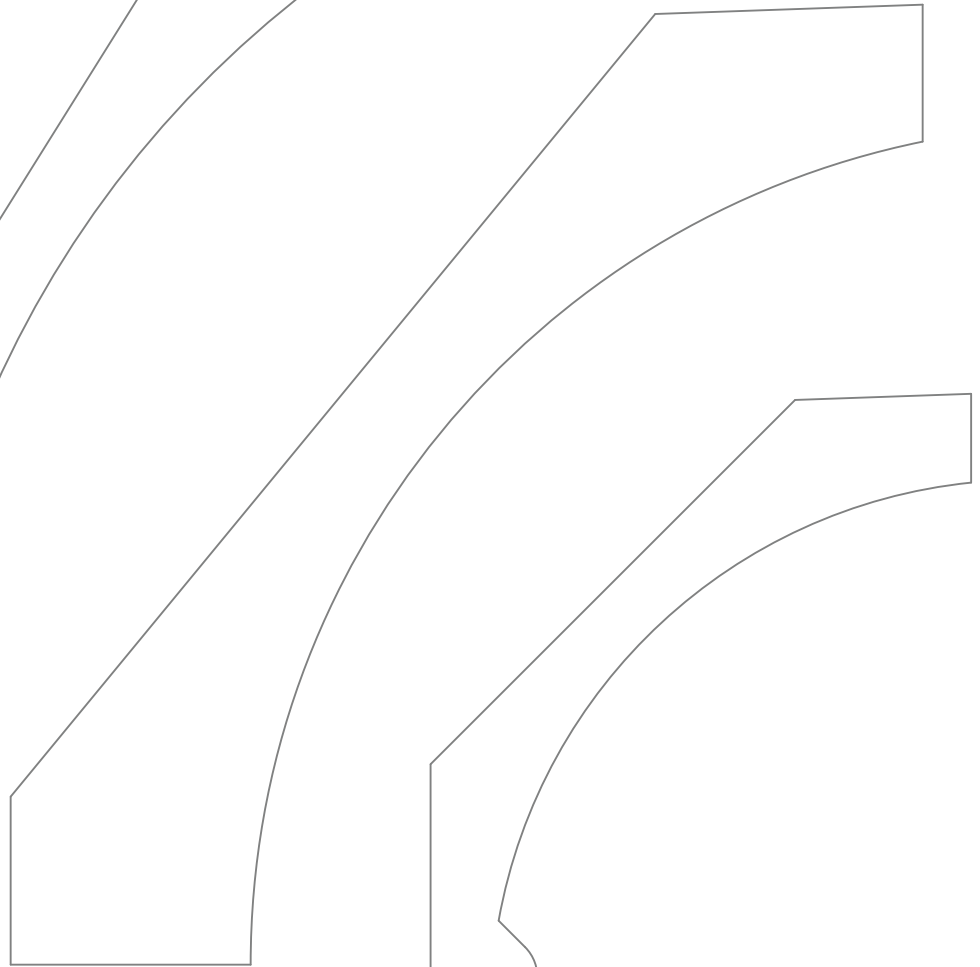

*PM-1330*

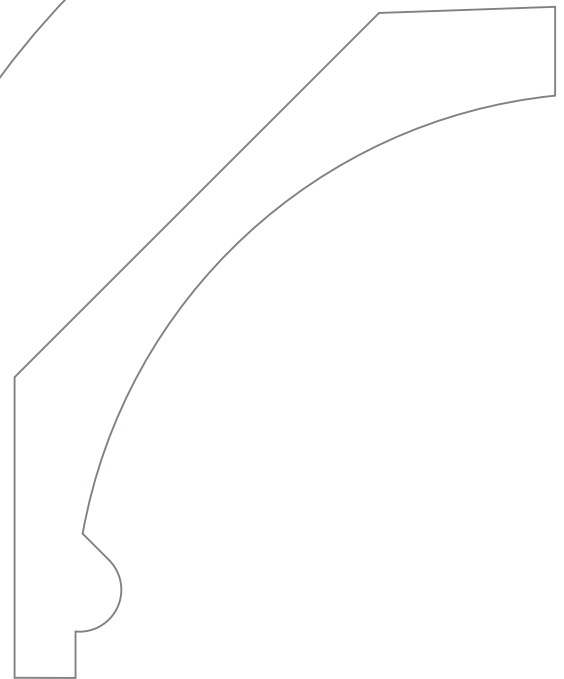

*PM-1329*



*PIERCE & PIERCE MILLWORK*

*FULL SCALE*

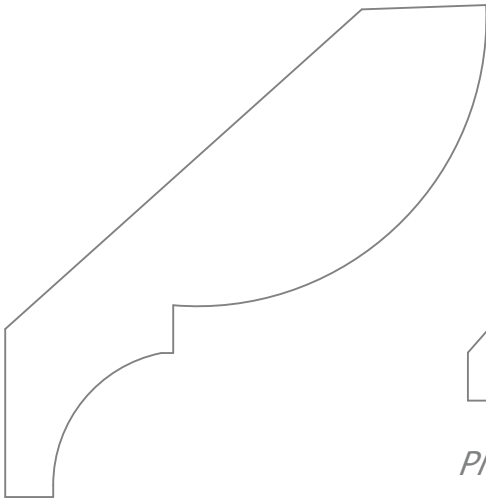

*PM-1318*

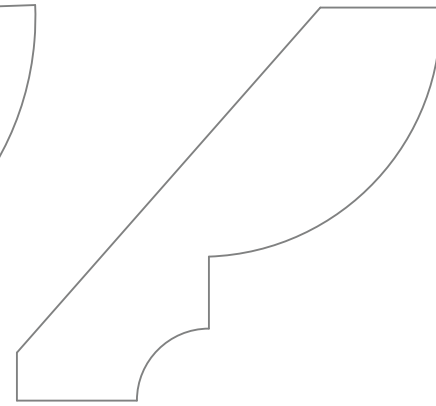

*PM-1324*

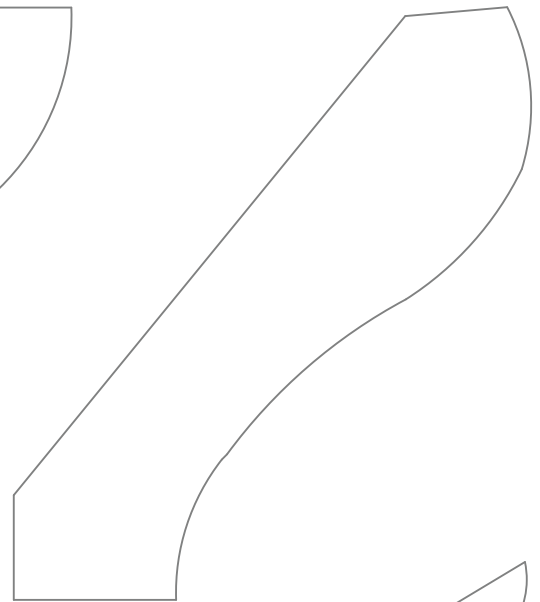

*PM-1334*

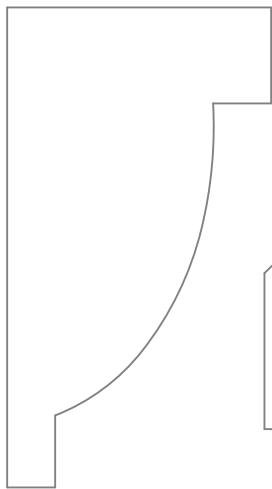

*PM-1335*

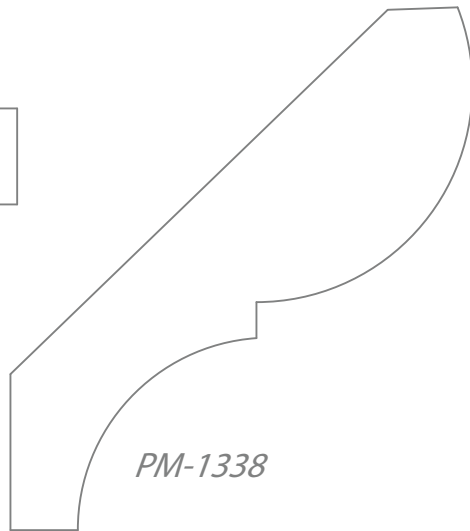

*PM-1338*

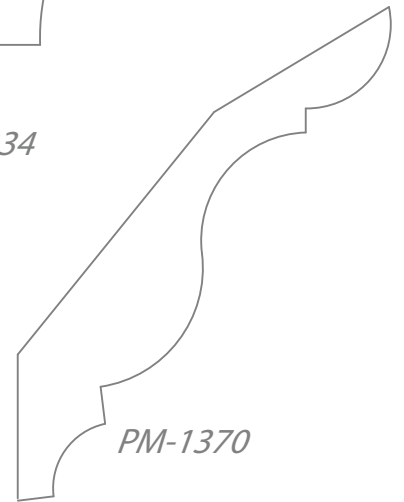

*PM-1370*

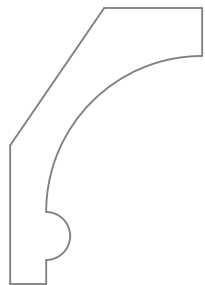

*PM-1365*

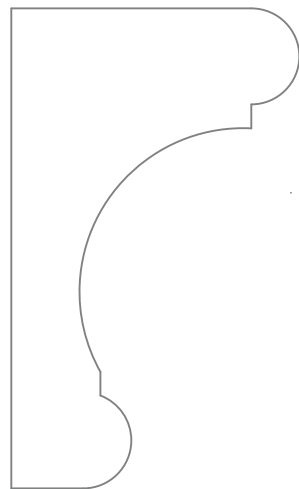

*PM-1381*

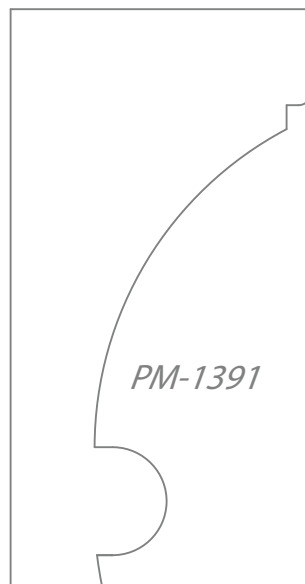

*PM-1391*

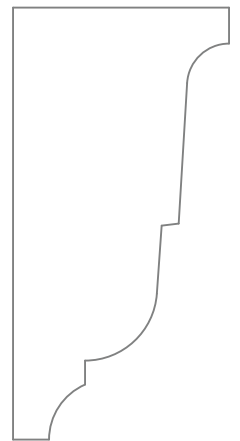

*PM-1386*

*PIERCE & PIERCE MILLWORK*

*FULL SCALE*

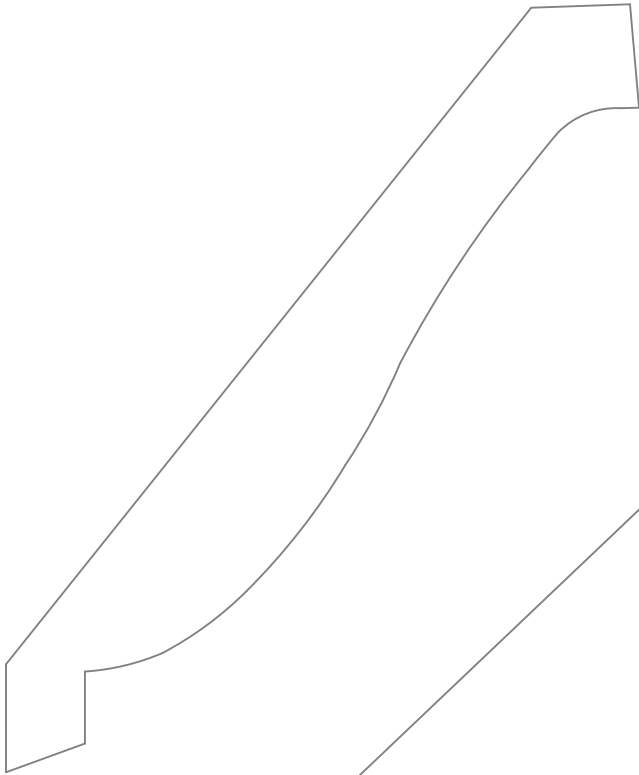

*PM-1349*



*PM-1328*

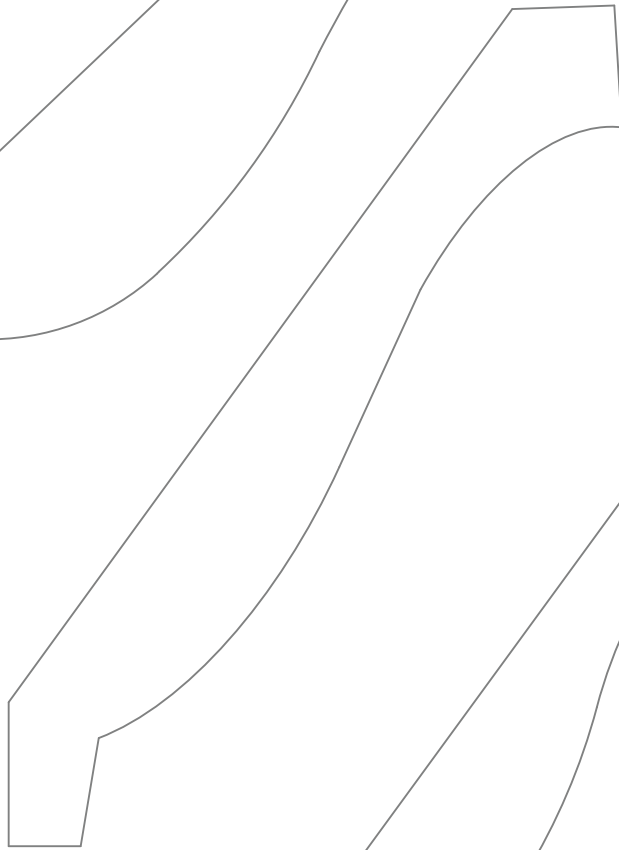

*PM-1373*



*PM-1350*

*PIERCE & PIERCE MILLWORK*

*FULL SCALE*

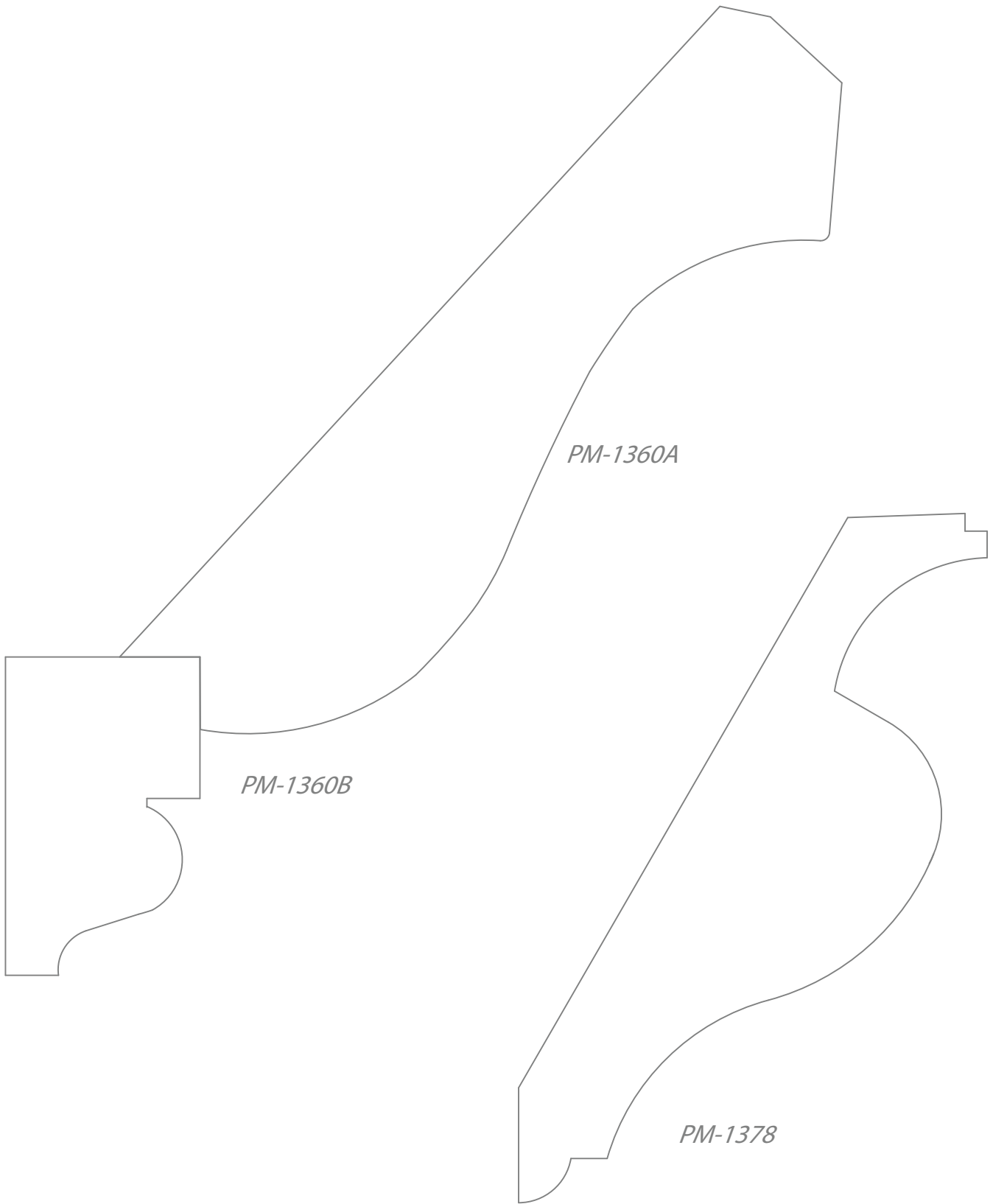

*PIERCE & PIERCE MILLWORK*

*FULL SCALE*



*PM-1362*

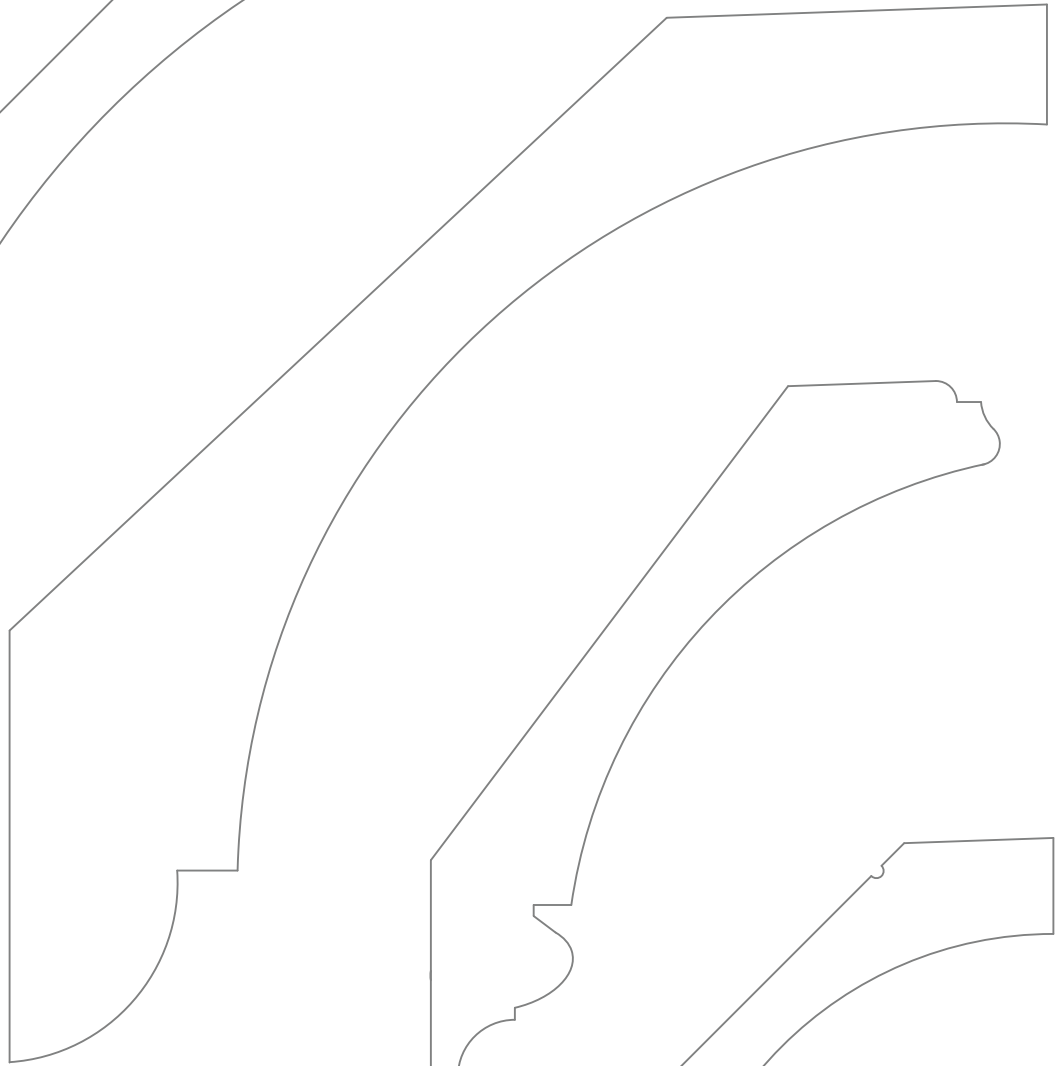

*PM-1376*

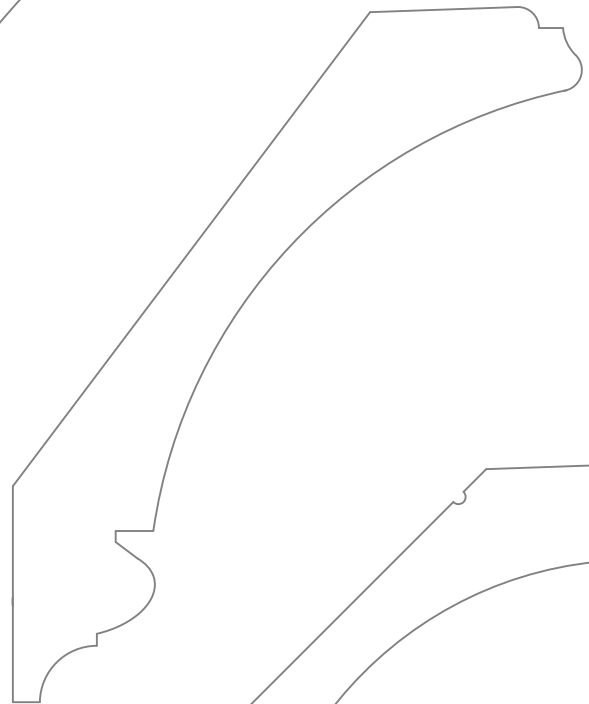

*PM-1377*

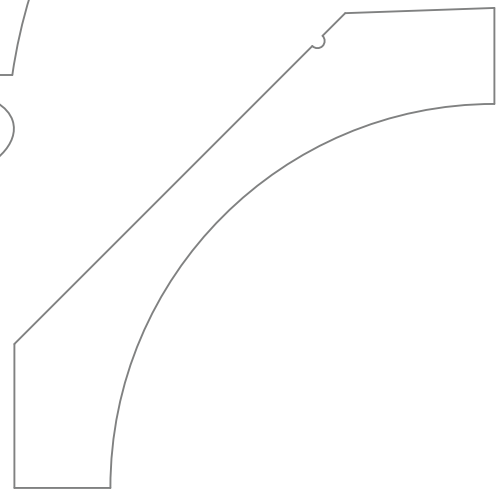

*PM-1385*

*PIERCE & PIERCE MILLWORK*

*FULL SCALE*

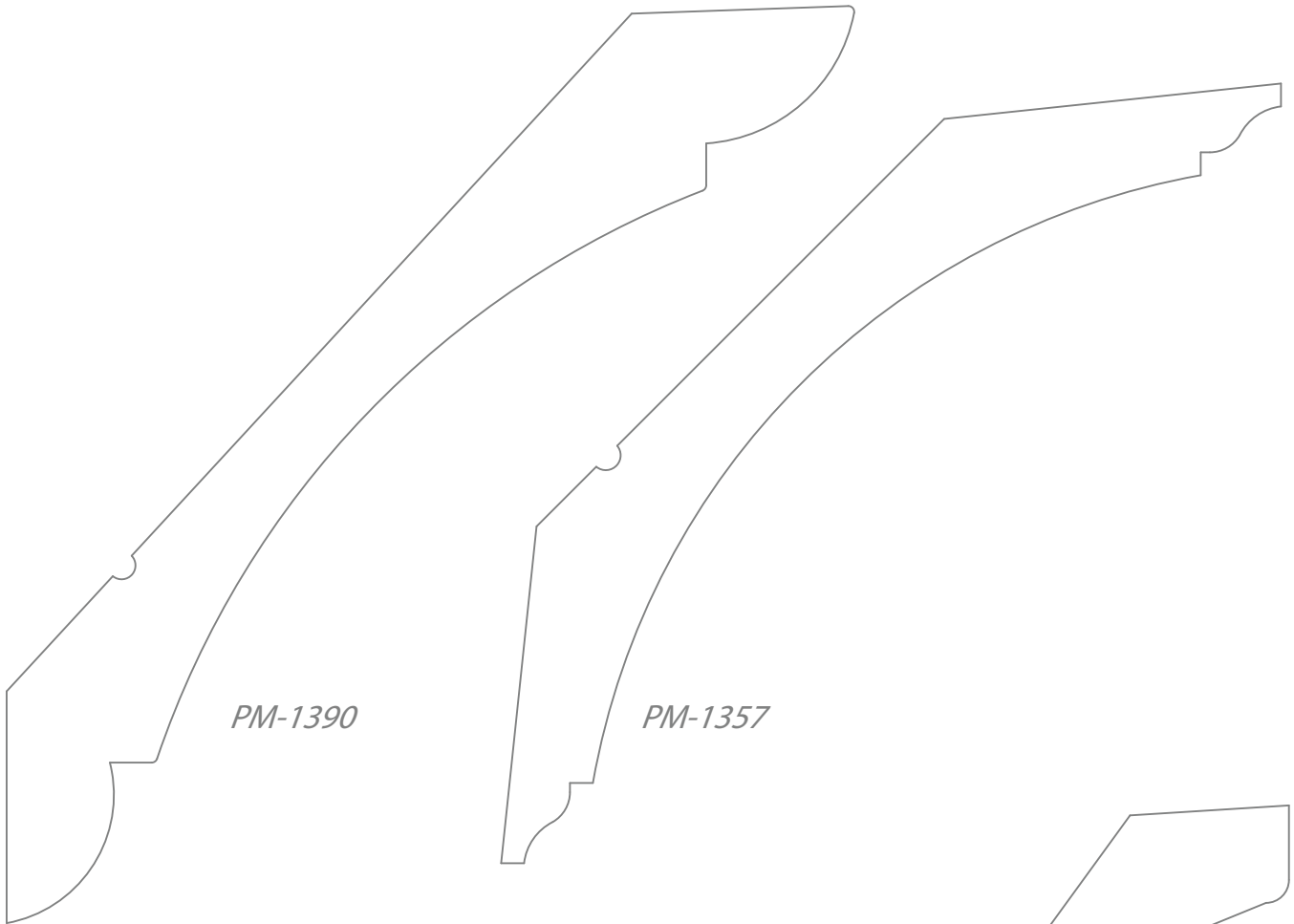

*PM-1390*

*PM-1357*

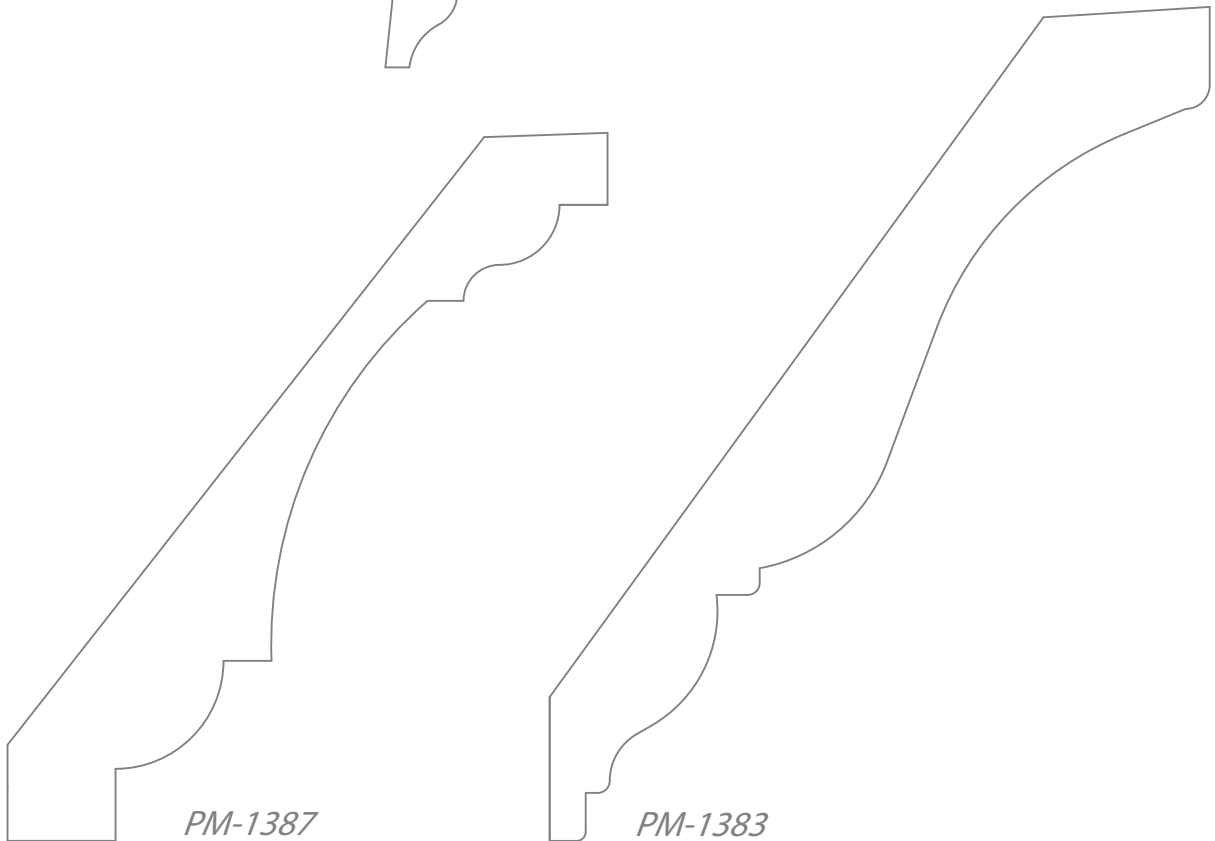

*PM-1387*

*PM-1383*

# PIERCE & PIERCE MILLWORK

FULL SCALE

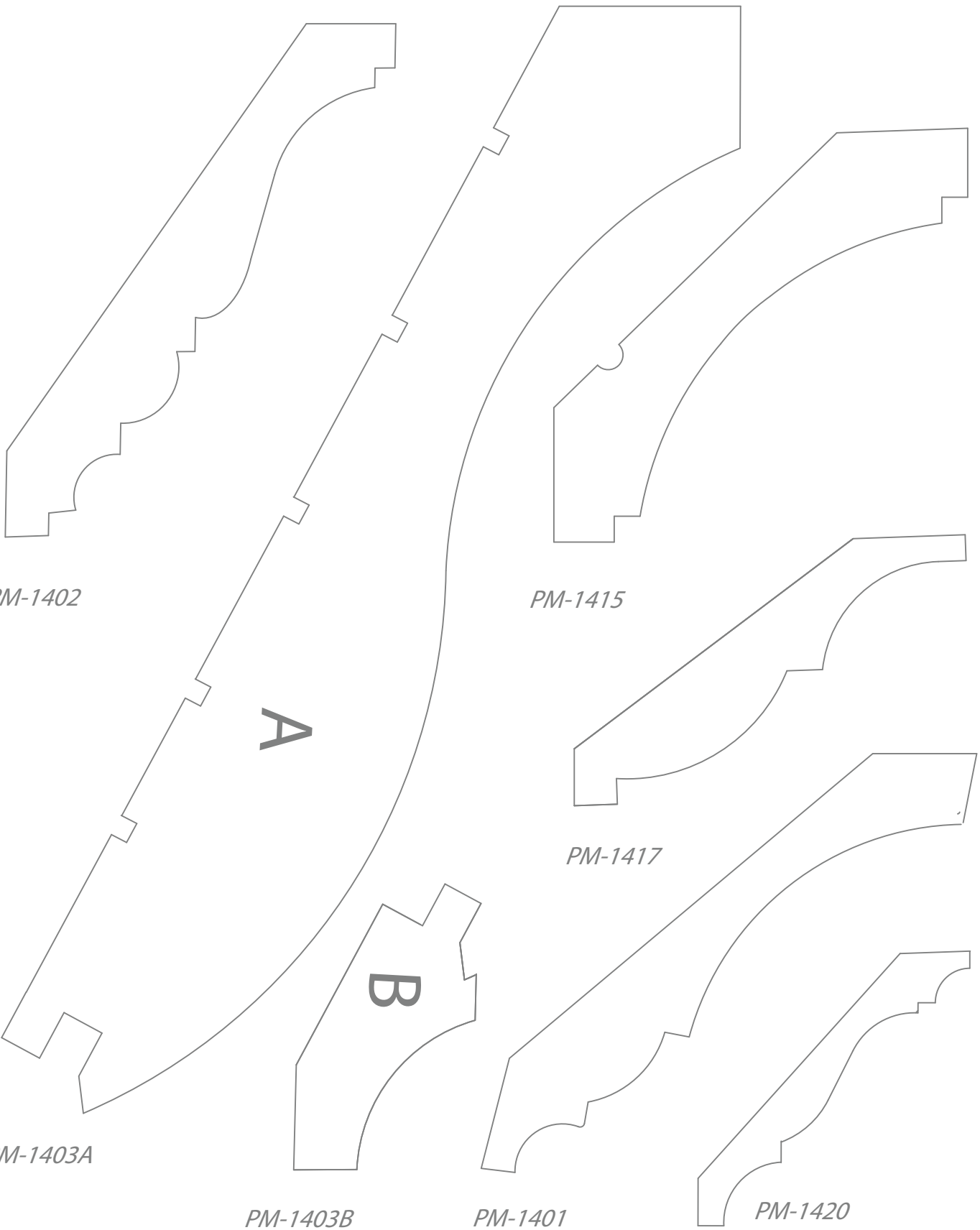

*PIERCE & PIERCE MILLWORK*

*FULL SCALE*

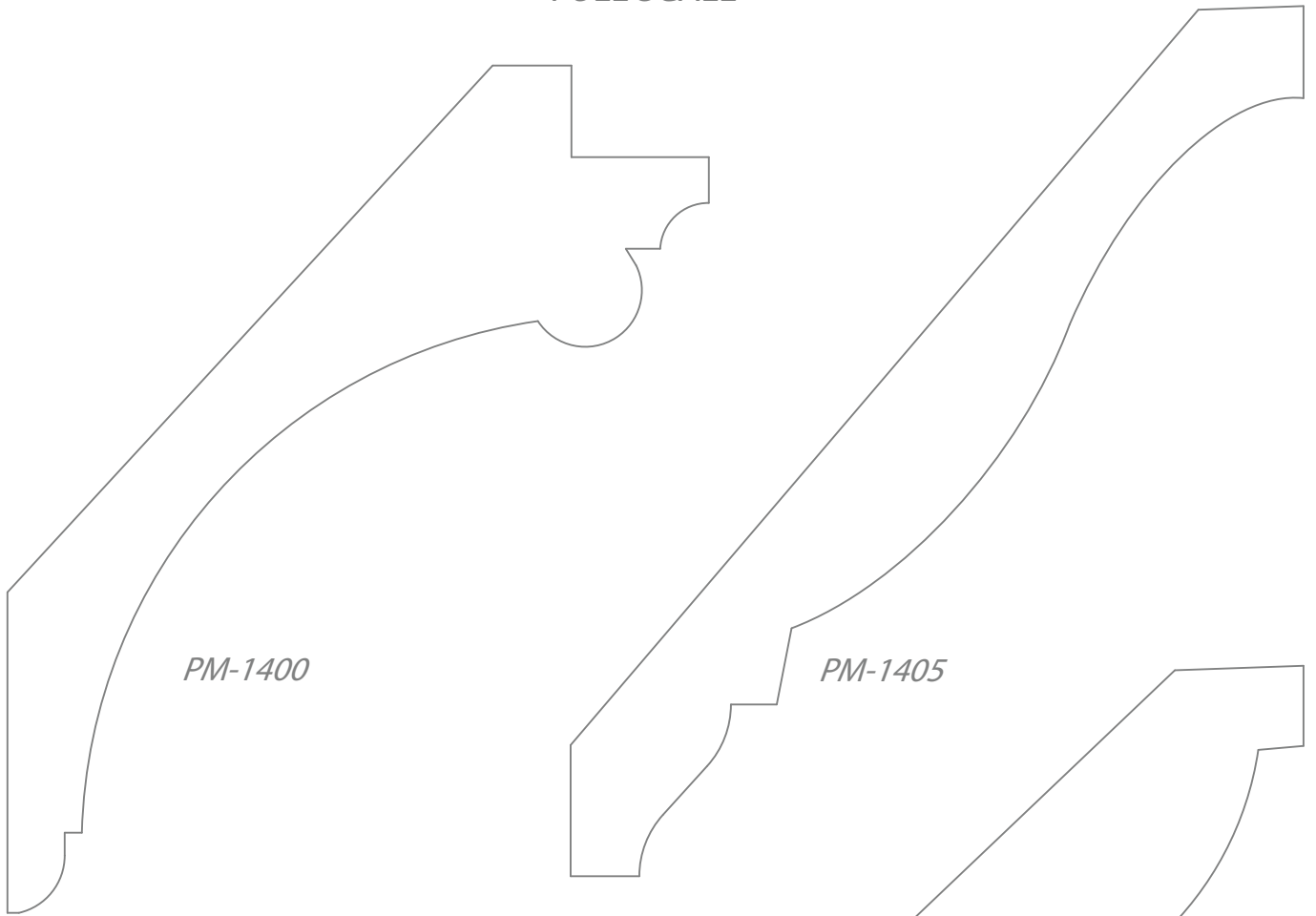

*PM-1400*

*PM-1405*

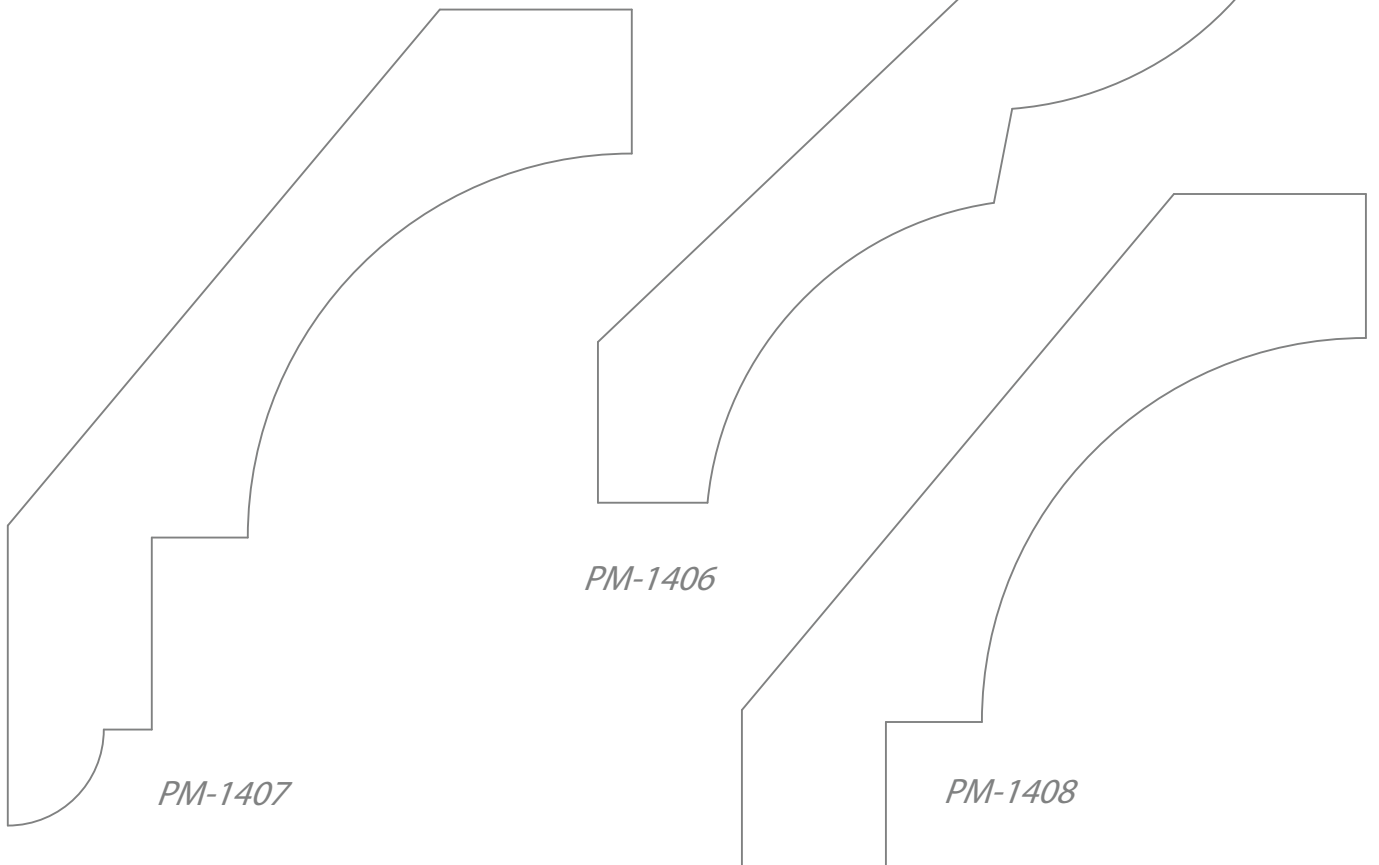

*PM-1406*

*PM-1407*

*PM-1408*

*PIERCE & PIERCE MILLWORK*

*FULL SCALE*

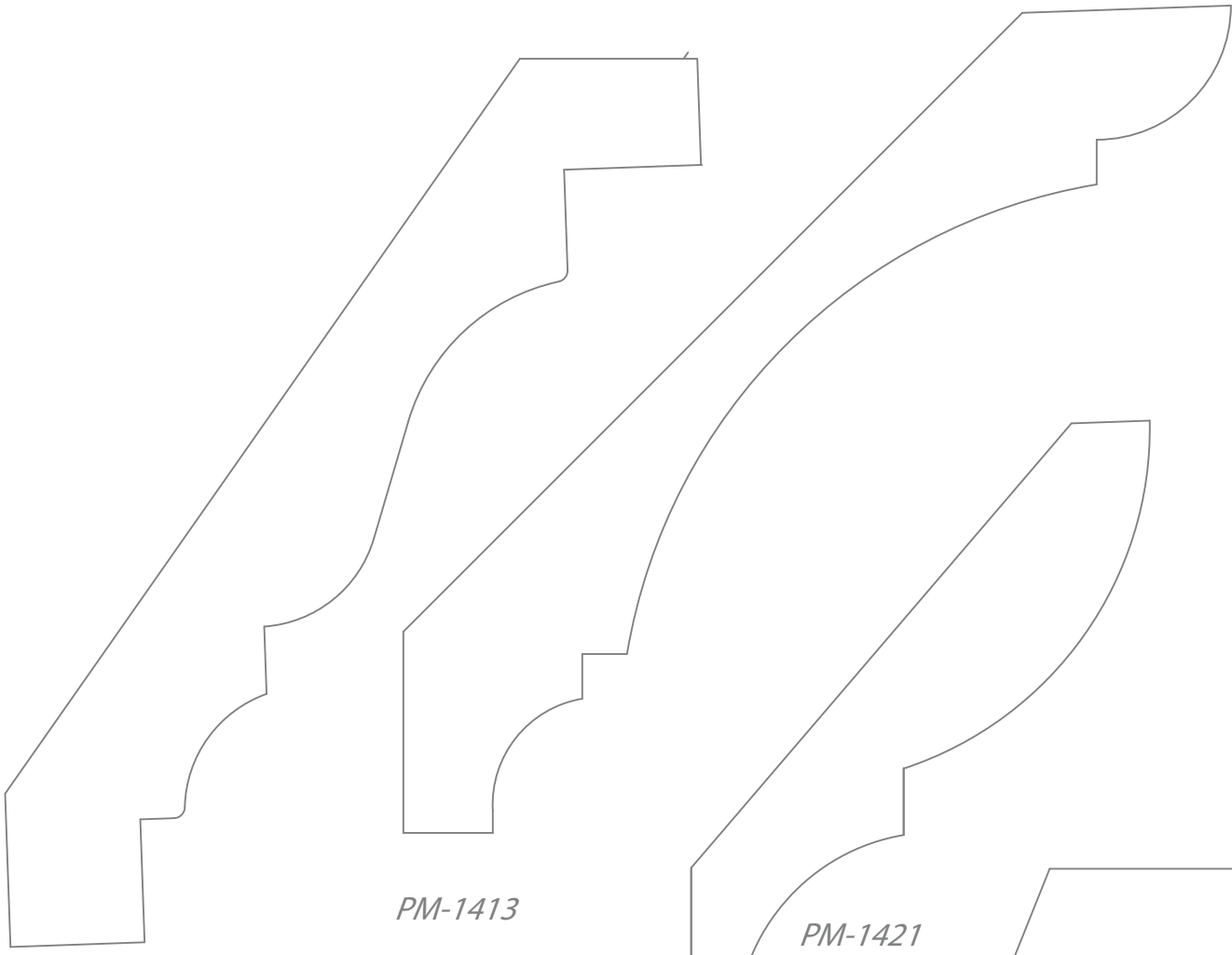

*PM-1410*

*PM-1413*

*PM-1421*

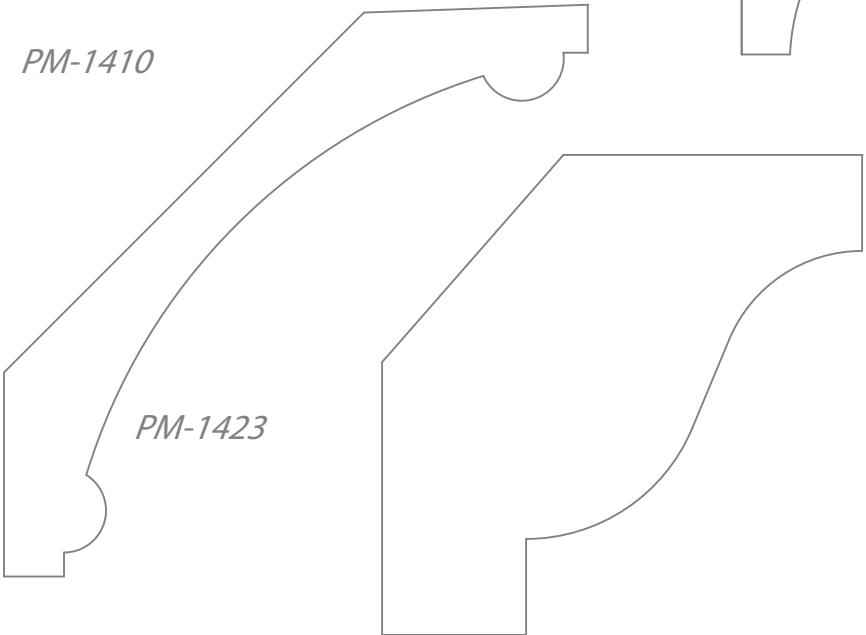

*PM-1423*

*PM-1422*

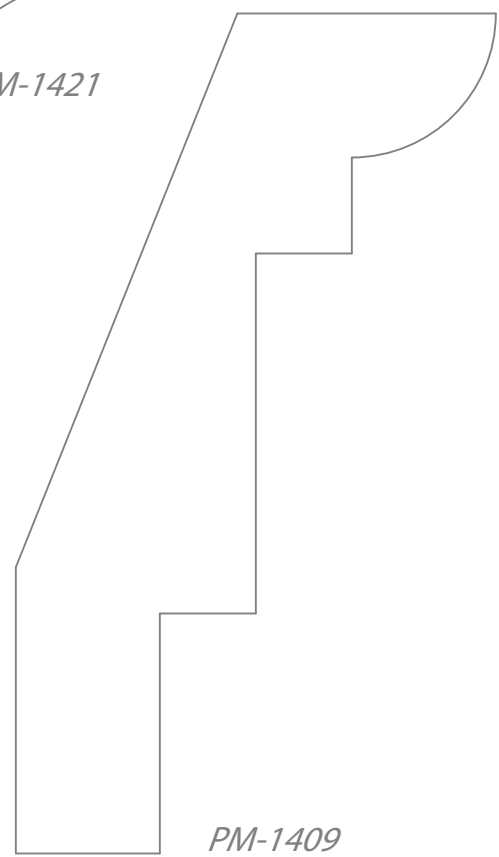

*PM-1409*



*PIERCE & PIERCE MILLWORK*

*FULL SCALE*

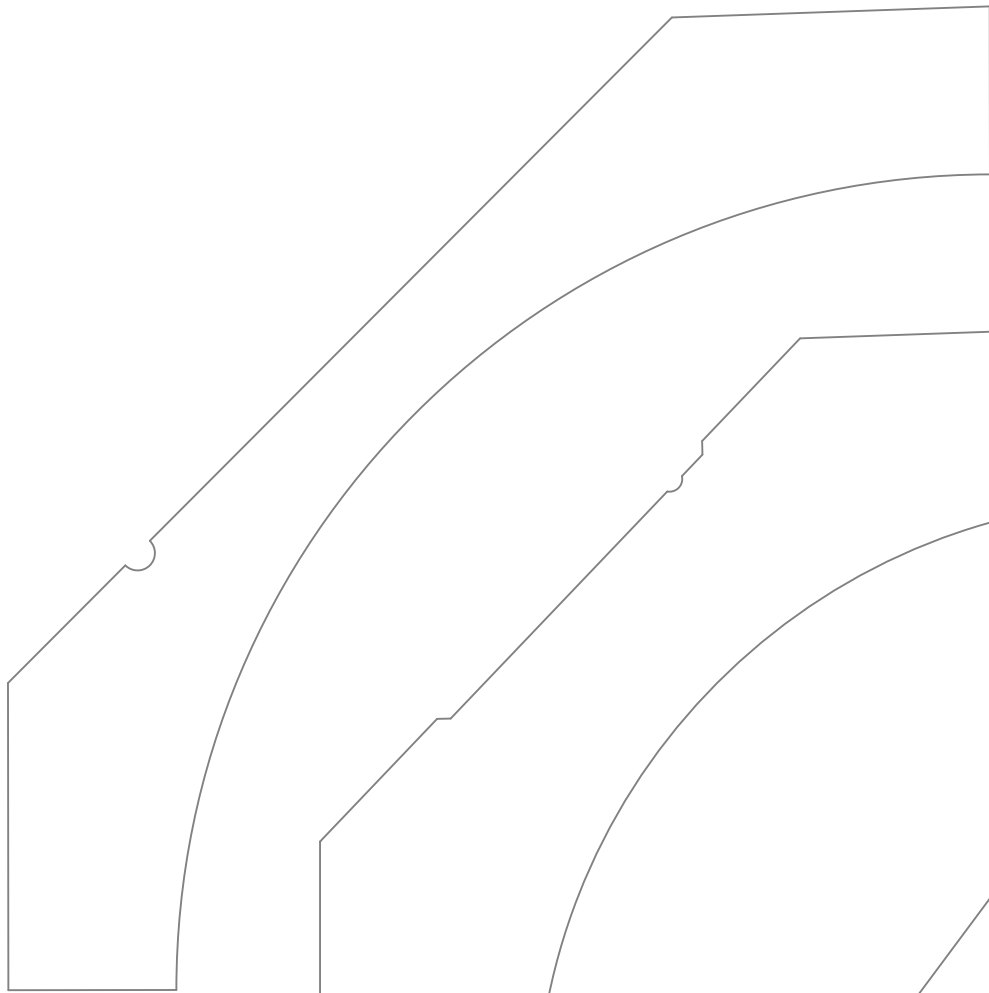

*PM-1419*

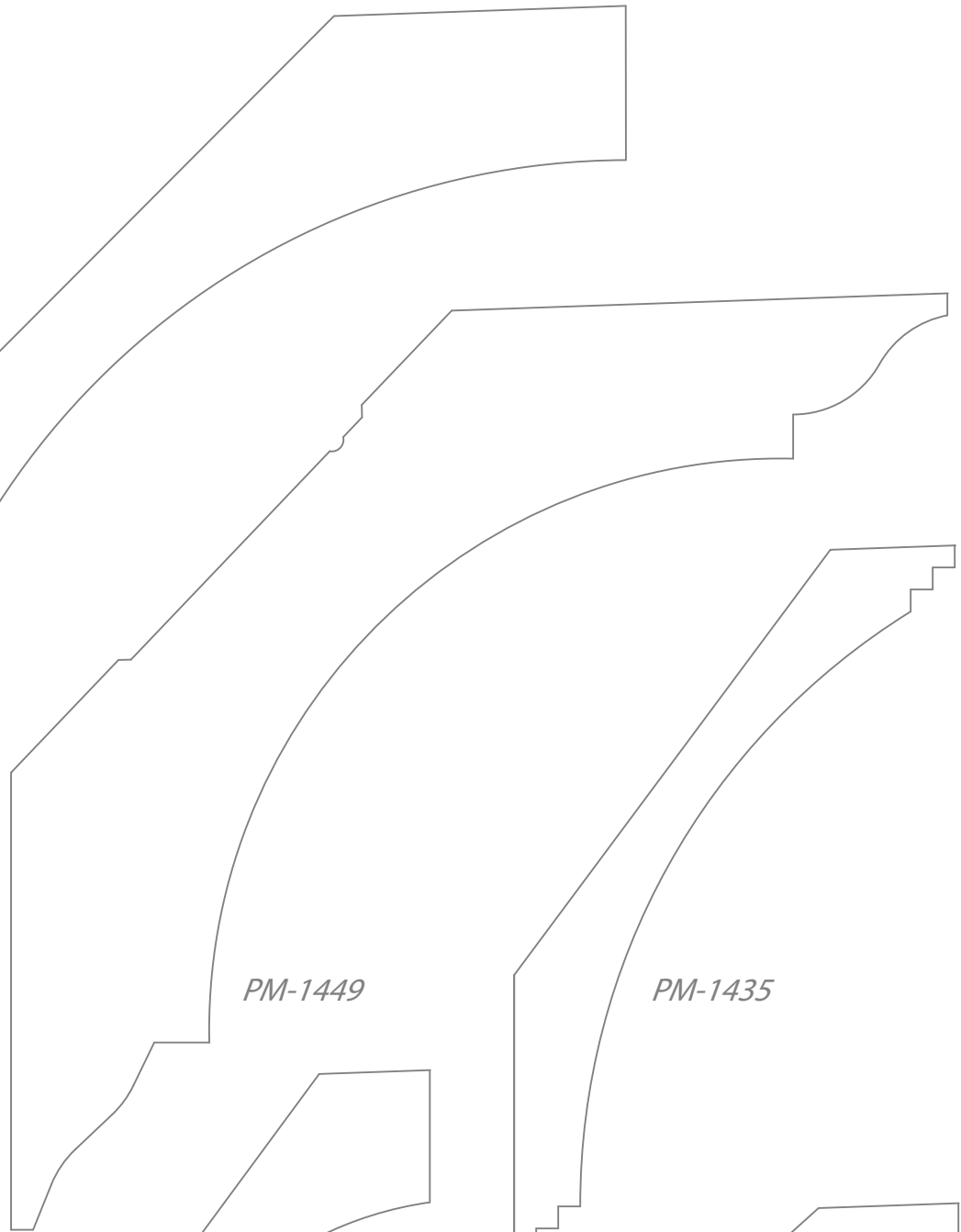

*PM-1449*

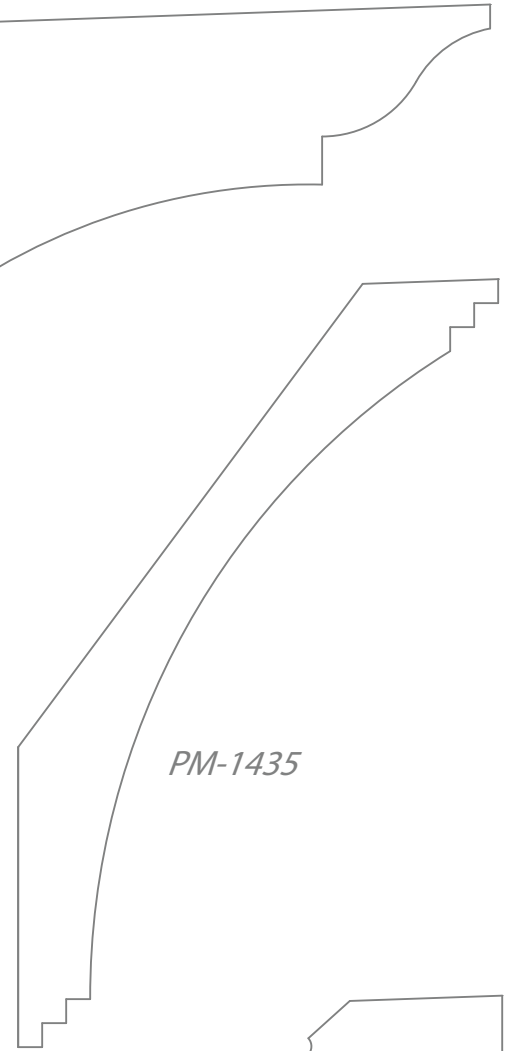

*PM-1435*

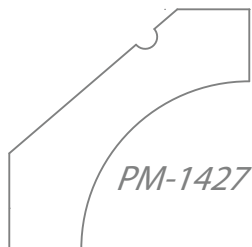

*PM-1427*

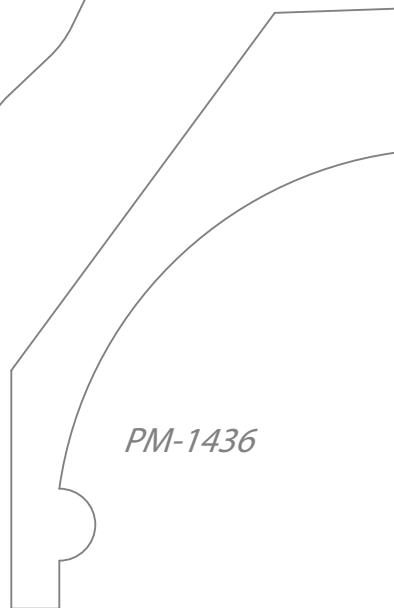

*PM-1436*

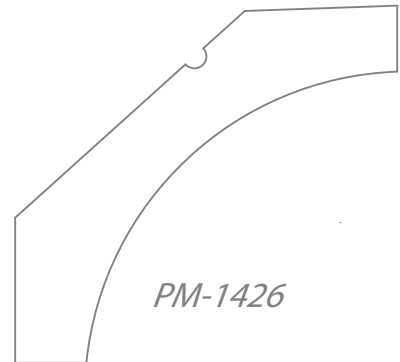

*PM-1426*

*PIERCE & PIERCE MILLWORK*

*FULL SCALE*

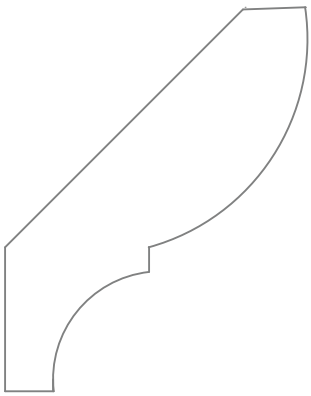

*PM-1432*

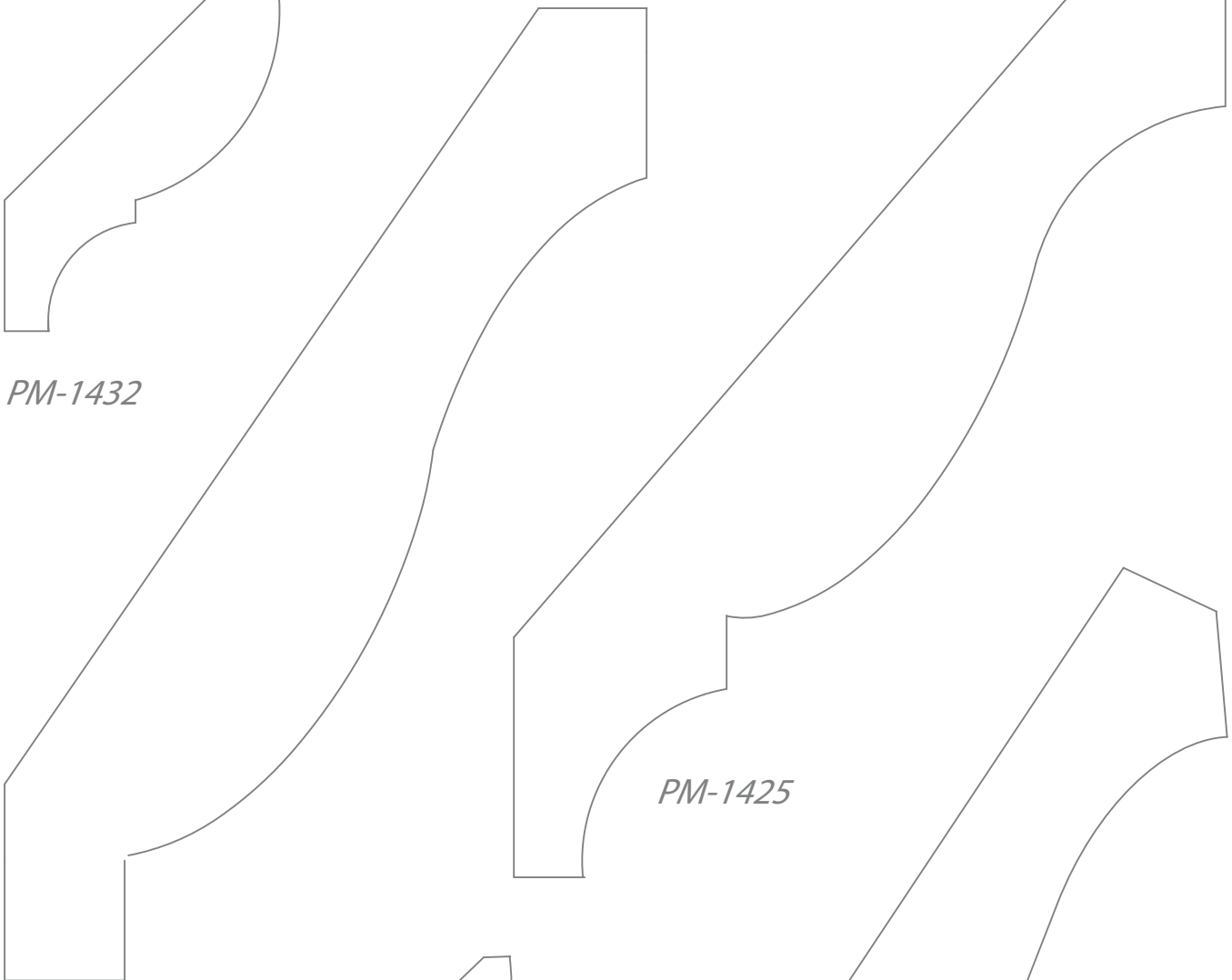

*PM-1425*

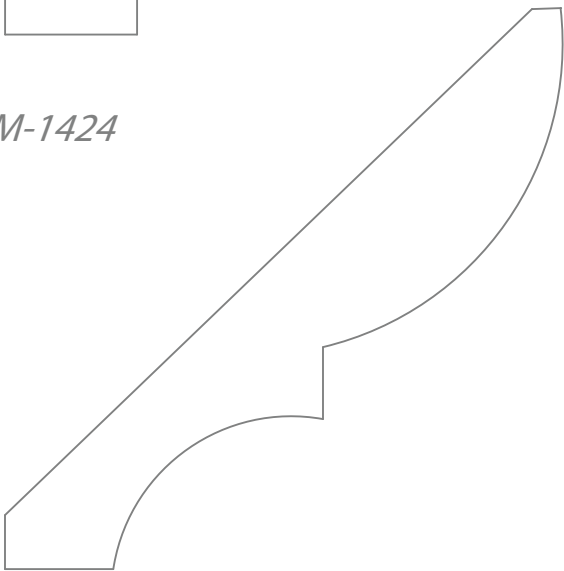

*PM-1424*

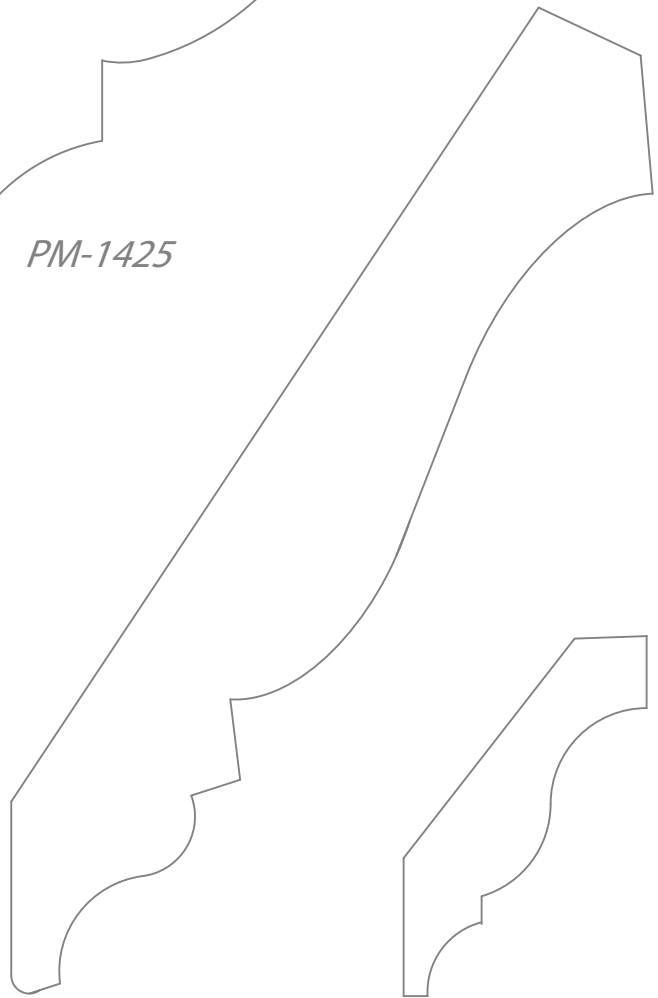

*PM-1429*

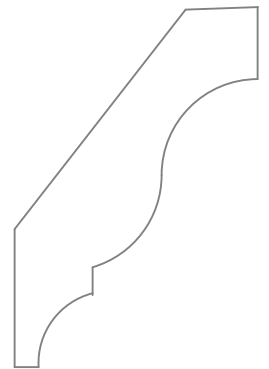

*PM-1438*

*PM-1428*

*PIERCE & PIERCE MILLWORK*

*FULL SCALE*

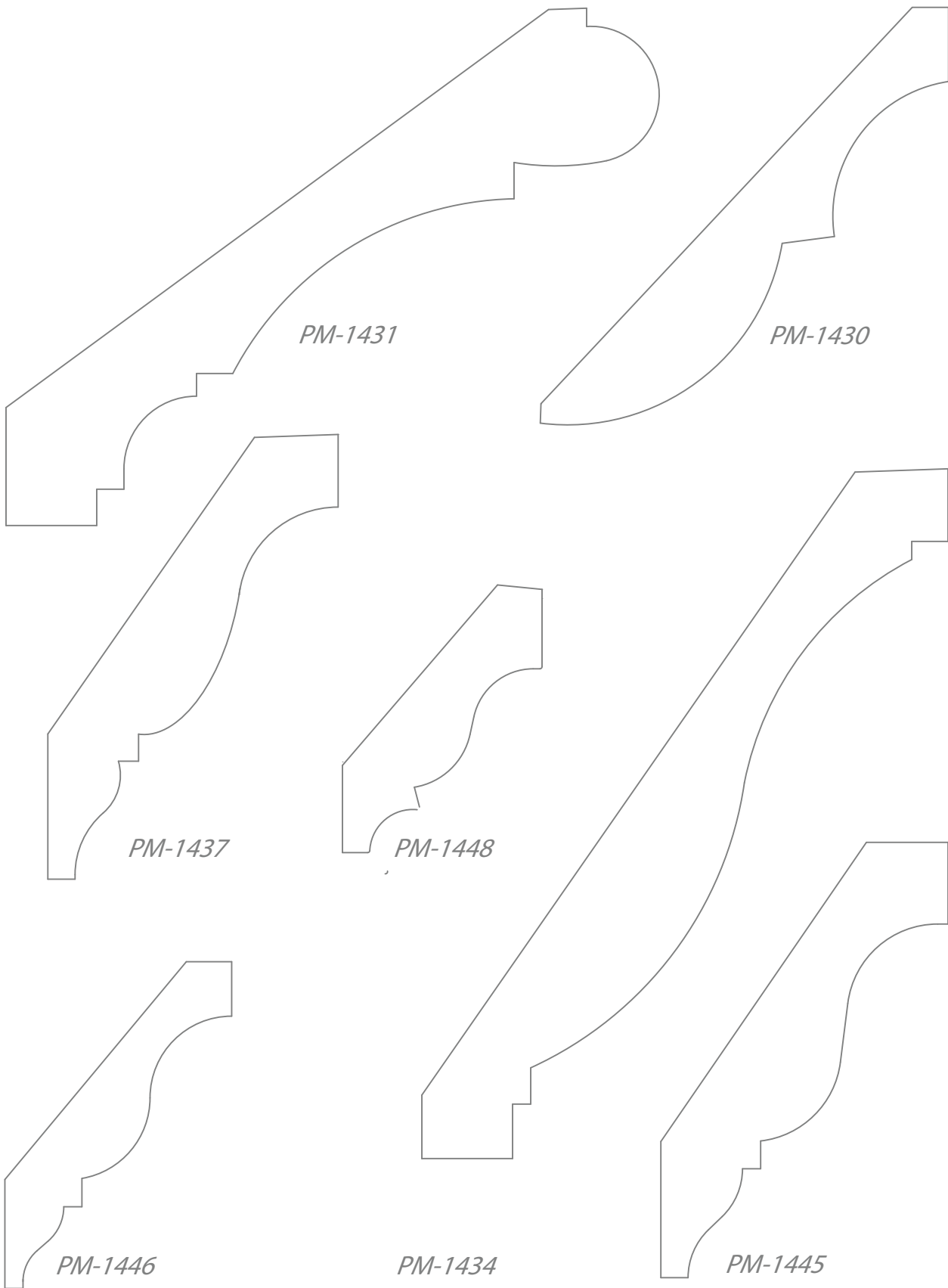

*PIERCE & PIERCE MILLWORK*

*FULL SCALE*

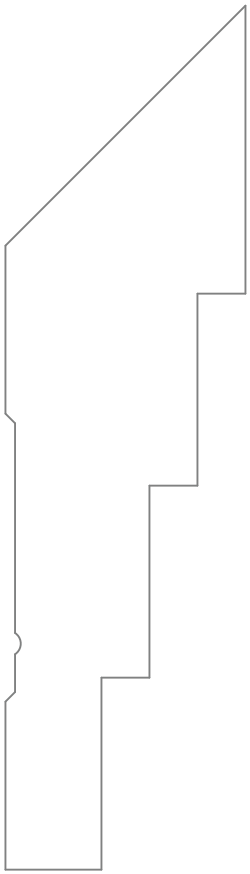

*PM-1441*

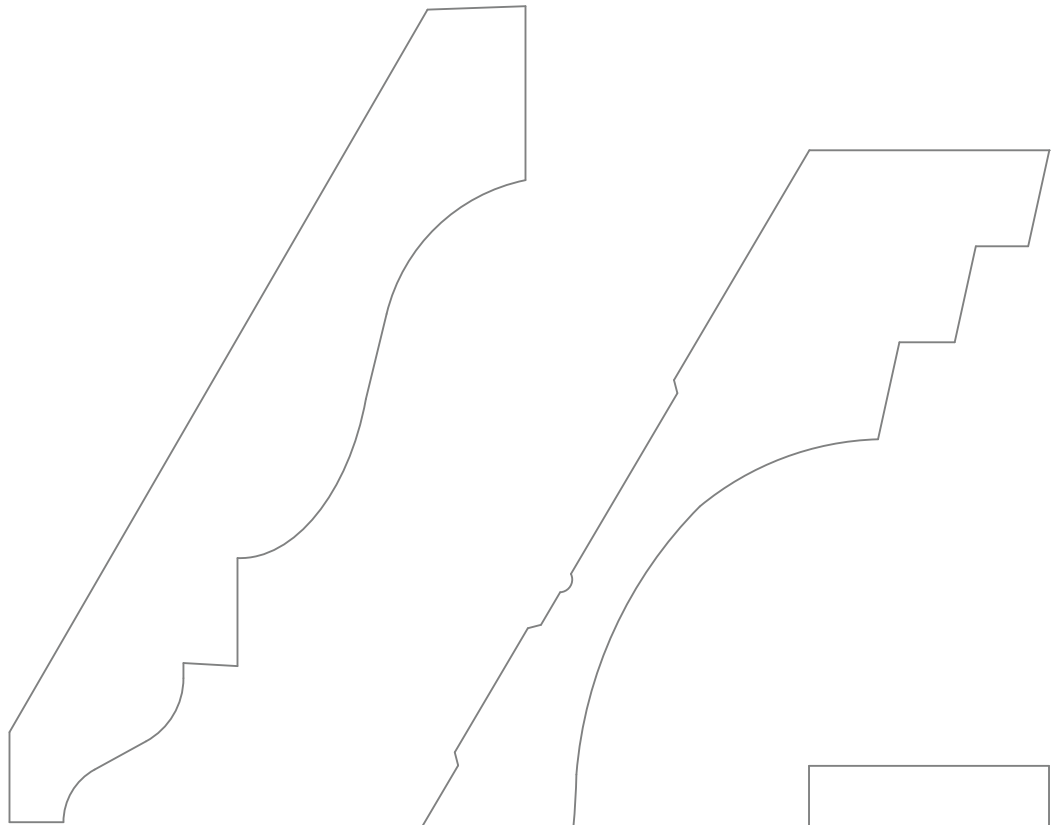

*PM-1444*

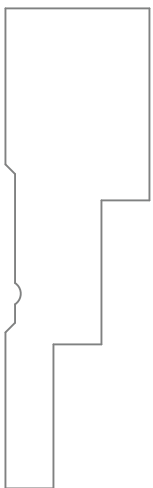

*PM-1440*



*PM-1450*

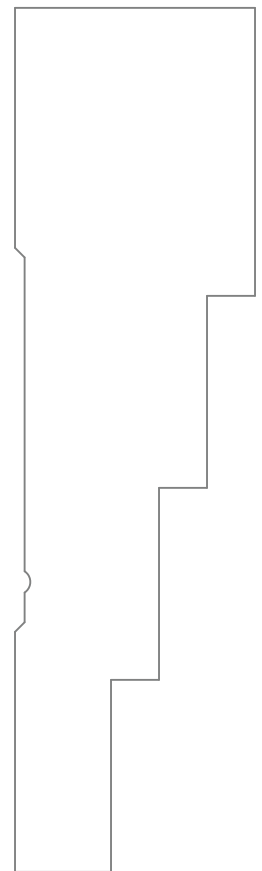

*PM-1439*

*PIERCE & PIERCE MILLWORK*

*FULL SCALE*

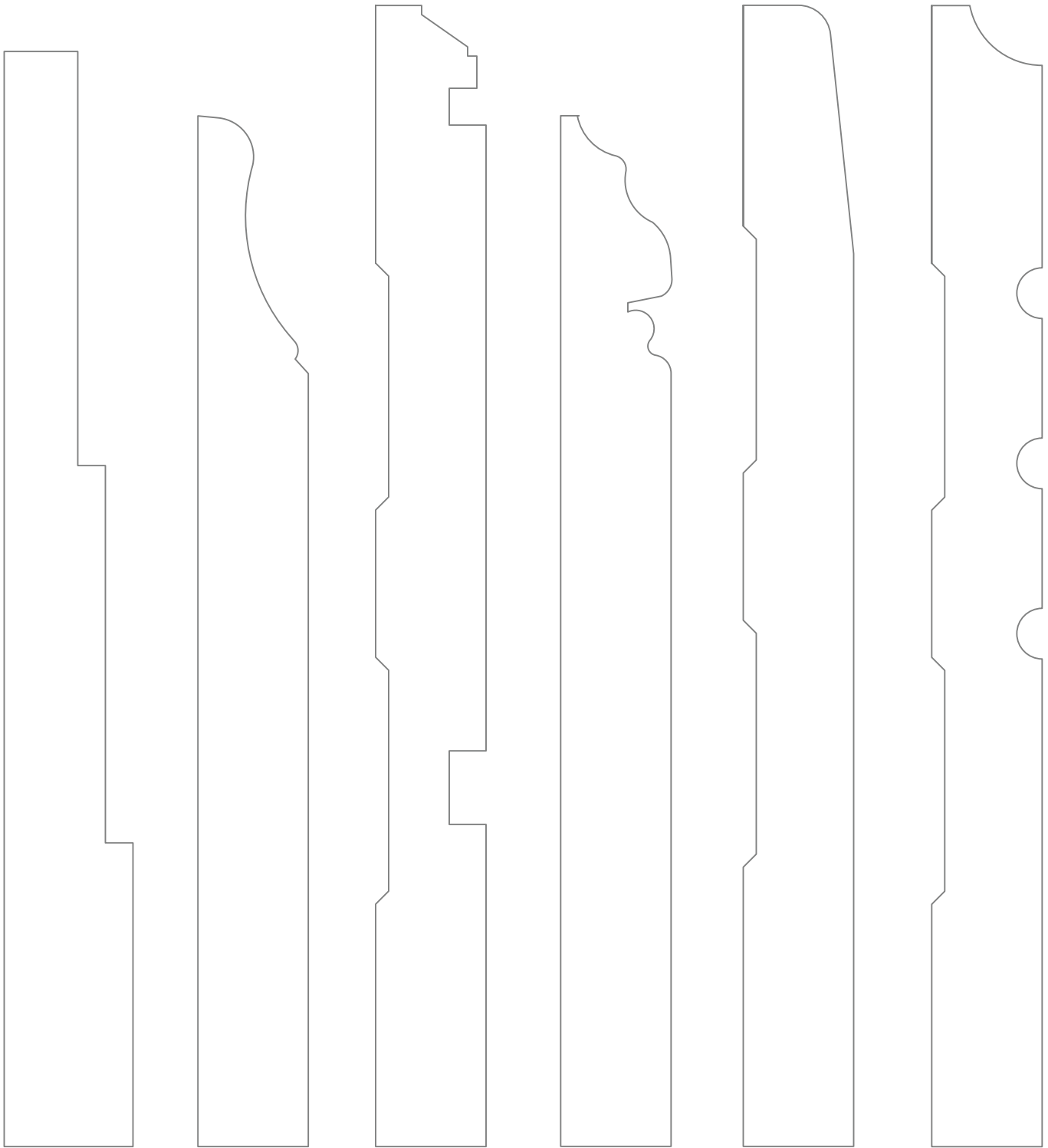

*PM-1501*

*PM-1502*

*PM-1520*

*PM-1503*

*PM-1522*

*PM-1523*

*PIERCE & PIERCE MILLWORK*

*FULL SCALE*

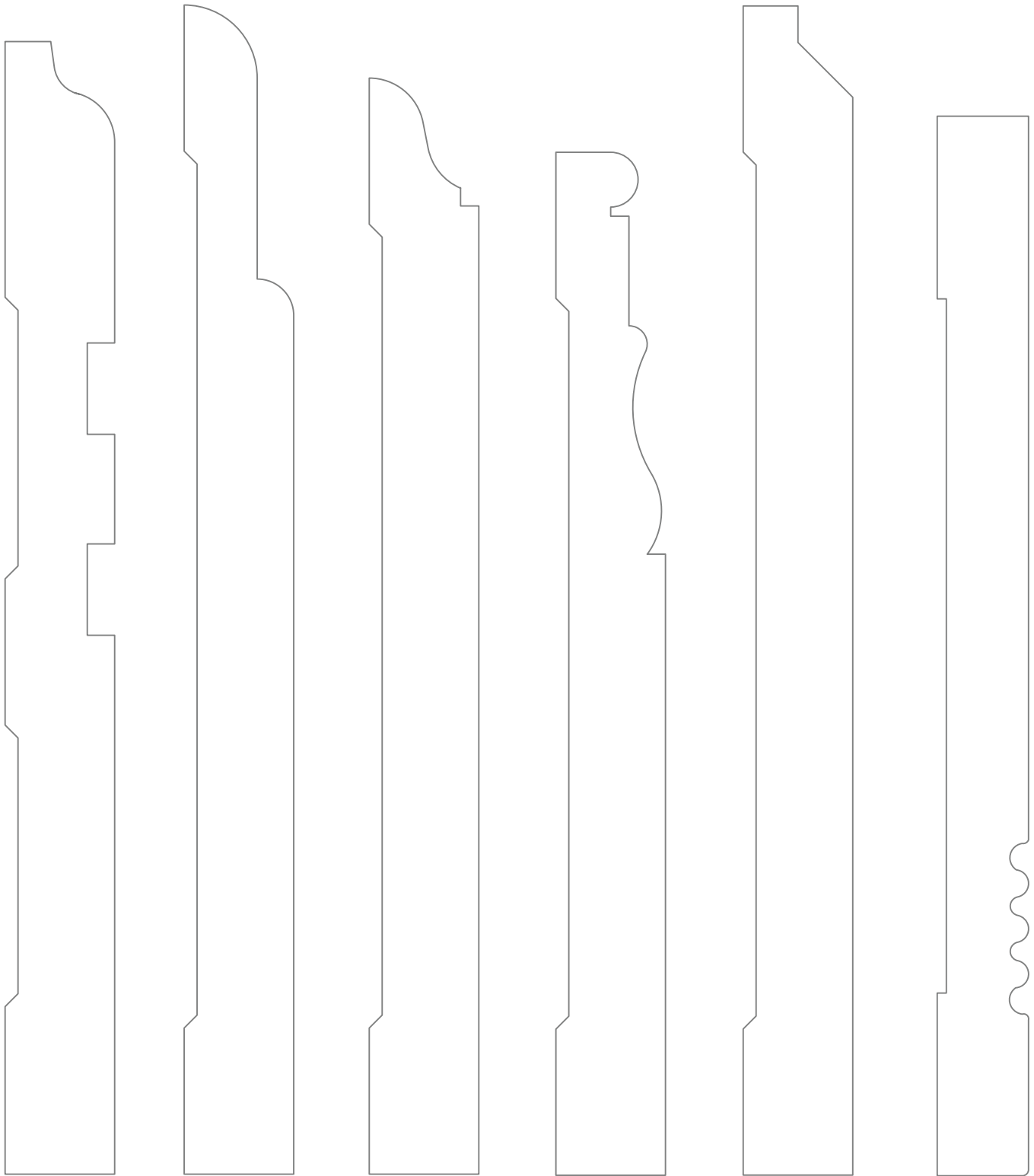

*PM-1525*

*PM-1573*

*PM-1580*

*PM-1583*

*PM-1585*

*PM-1587*

*PIERCE & PIERCE MILLWORK*

*FULL SCALE*



*PM-1598*



*PM-1524*



*PM-1533*

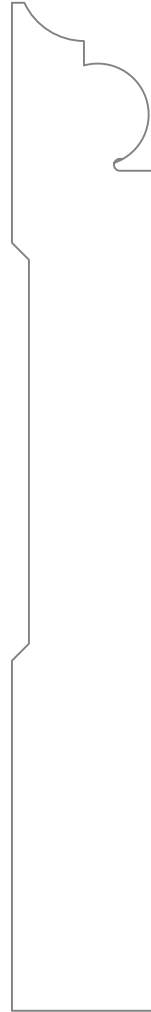

*PM-1537*

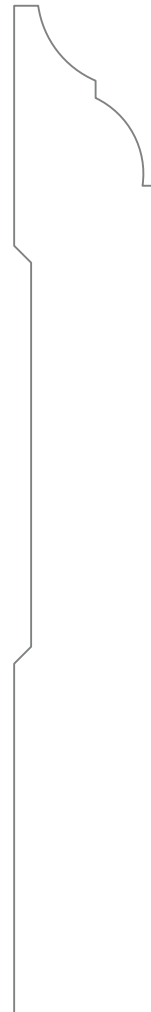

*PM-1538*

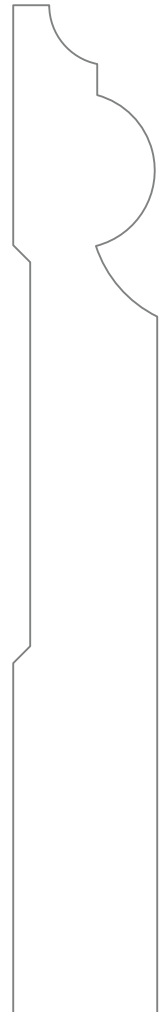

*PM-1539*

*PIERCE & PIERCE MILLWORK*

*FULL SCALE*

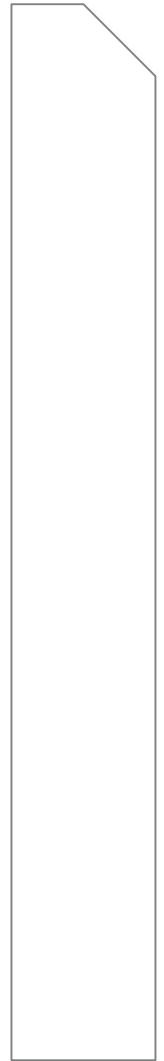
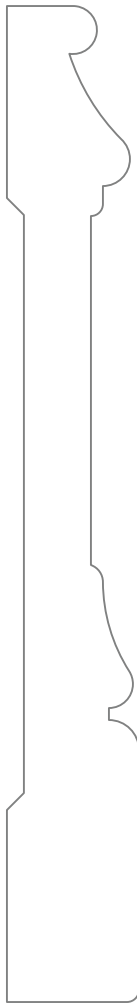

*PM-1540*

*PM-1547*

*PM-1551*

*PM-1562*

*PM-1565*

*PM-1567*



*PIERCE & PIERCE MILLWORK*

*FULL SCALE*



*PM-1572*



*PM-1554*

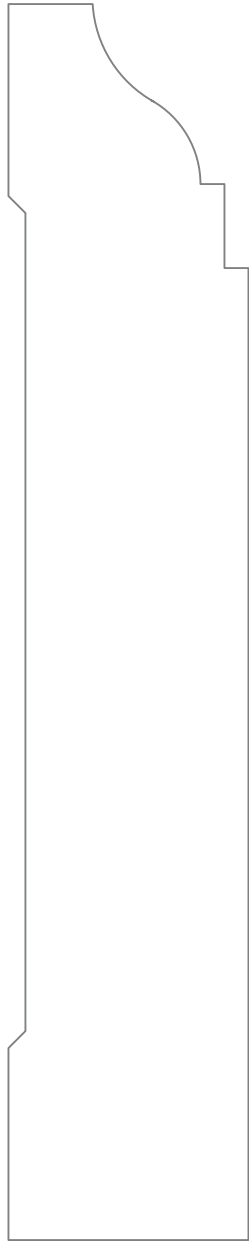

*PM-1578*



*PM-1581*



*PM-1555*



*PM-1557*

*PIERCE & PIERCE MILLWORK*

*FULL SCALE*



*PN-1511*

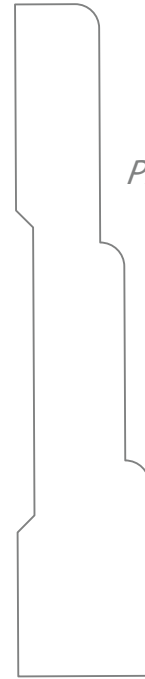

*PM-1599*



*PM-1595*



*PM-1507*



*PM-1588*



*PM-1505*



*PM-1506*

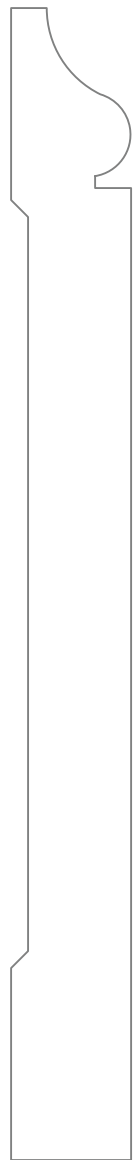

*PM-1577*

# PIERCE & PIERCE MILLWORK

FULL SCALE

PM-1526

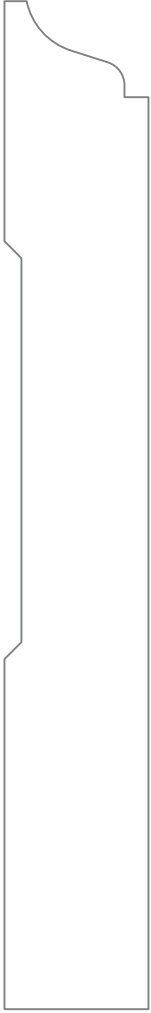

PM-1510



PM-1515



PM-1512

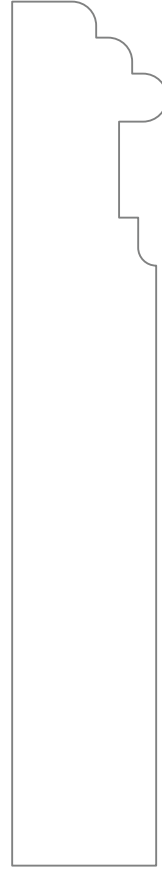

PM-1530

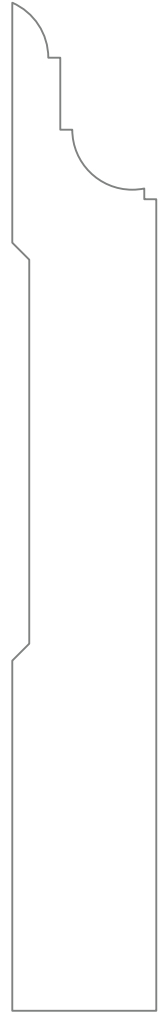

PM-1514



PM-1516



PM-1542



PM-1584



PM-1559

# PIERCE & PIERCE MILLWORK

FULL SCALE

PM-1517

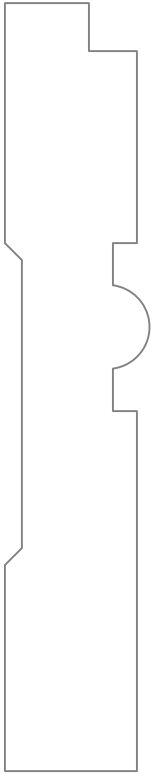

PM-1556



PM-1558



PM-1560

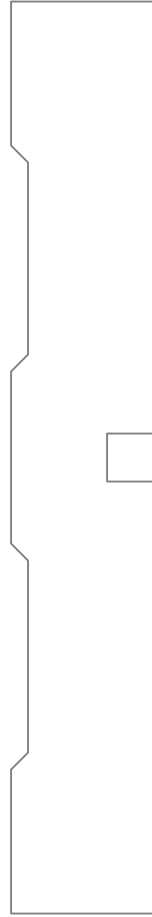

PM-1566

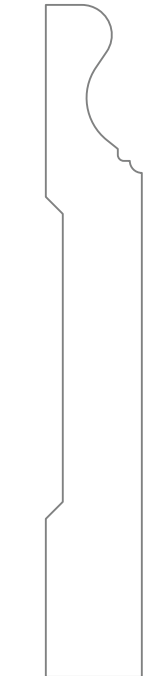
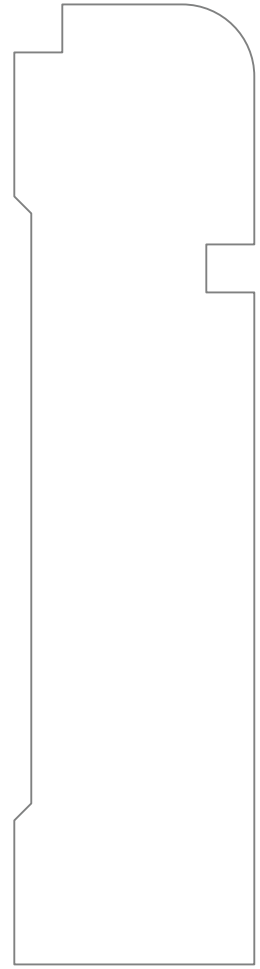

PM-1531



PM-1574



PM-1508



PM-1513



PM-1593

# PIERCE & PIERCE MILLWORK

FULL SCALE

PM-1518



PM-1519



PM-1521



PM-1528

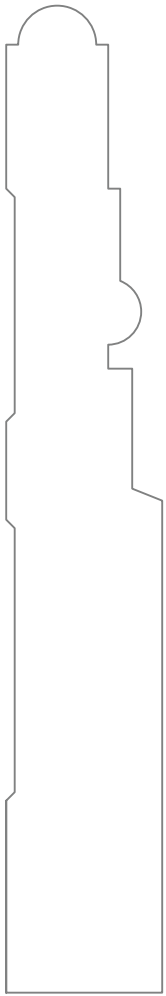
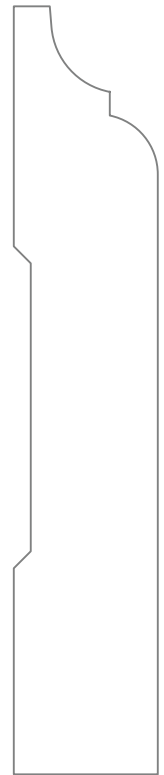

PM-1504



PM-1529

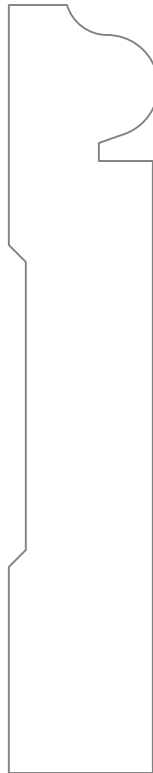

PM-1532



PM-1534

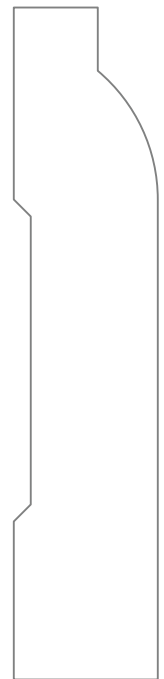

PM-1535

*PIERCE & PIERCE MILLWORK*

*FULL SCALE*



*PM-1536*

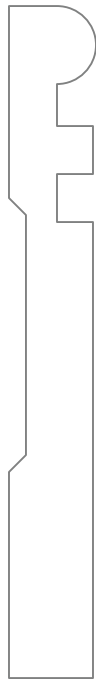

*PM-1541*



*PM-1543*



*PM-1544*



*PM-1545*



*PM-1546*



*PM-1548*

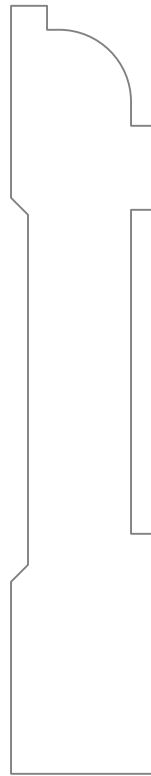

*PM-1549*



*PM-1552*



*PM-1553*

# PIERCE & PIERCE MILLWORK

FULL SCALE

PM-1571



PM-1563

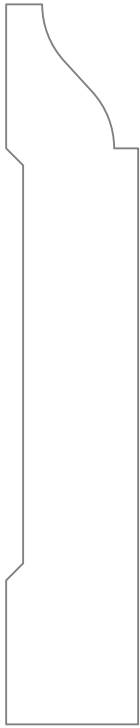

PM-1564



PM-1561



PM-1575 E

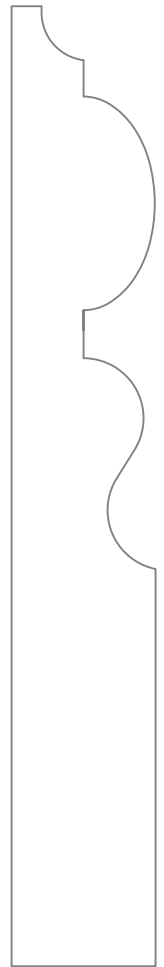

PM-1589



PM-1586



PM-1592



PM-1579

*PIERCE & PIERCE MILLWORK*

*FULL SCALE*

*PM-1594*

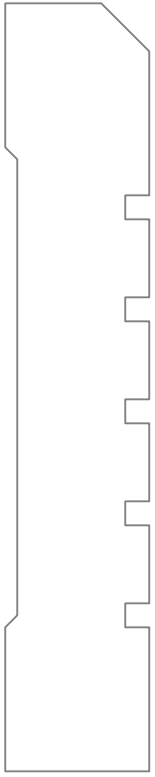

*PM-1596*



*PM-1597*



*PM-1601*



*PM-1603*



*PM-1612*

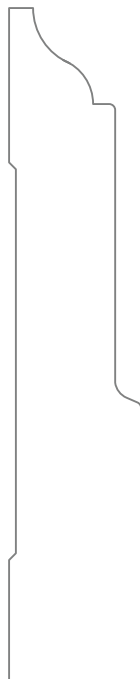

*PM-1640*

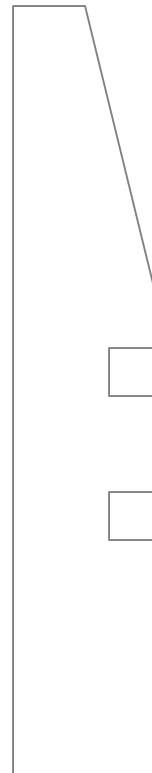

*PM-1620*



*PM-1643*



*PIERCE & PIERCE MILLWORK*

*FULL SCALE*

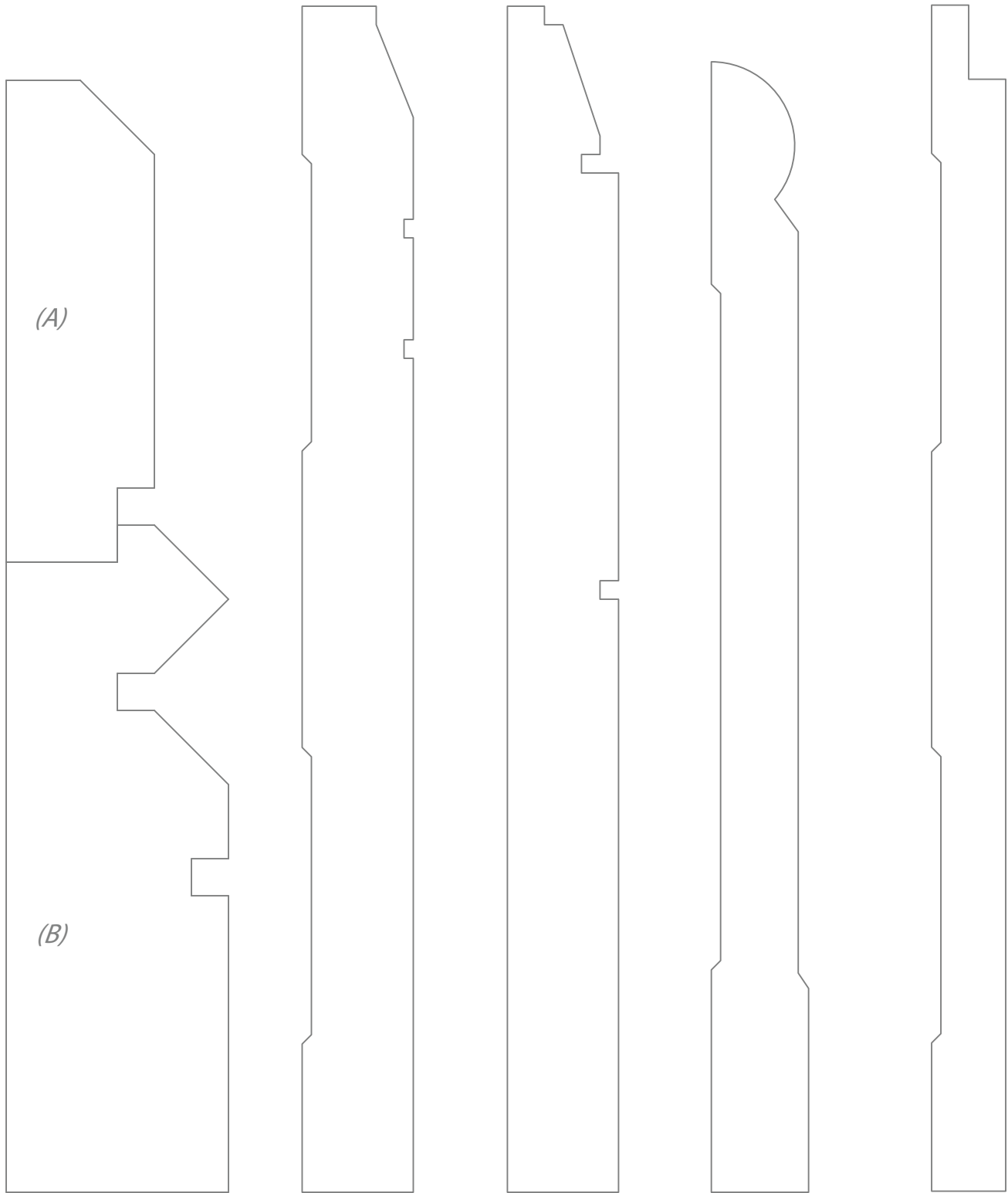

*PM-1600*

*PM-1606*

*PM-1608*

*PM-1614*

*PM-1617*

*PIERCE & PIERCE MILLWORK*

*FULL SCALE*

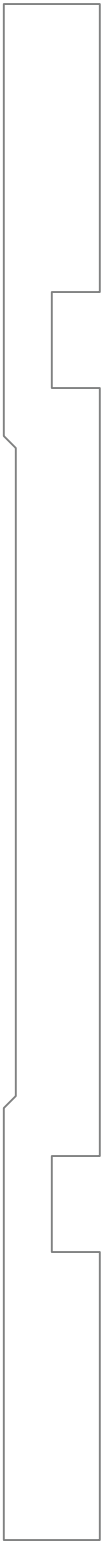

*PM-1618*

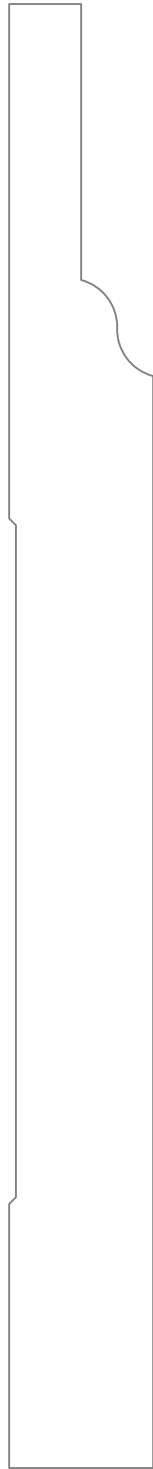

*PM-1641*

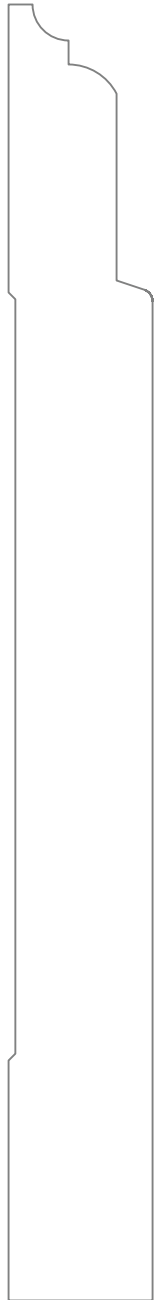

*PM-1644*



*PM-1662*



*PM-1660*

*PIERCE & PIERCE MILLWORK*

*FULL SCALE*

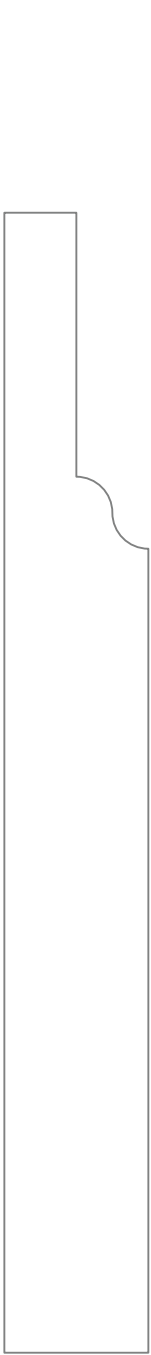

*PM-1647*



*PM-1653*



*PM-1663*



*PM-1617M*

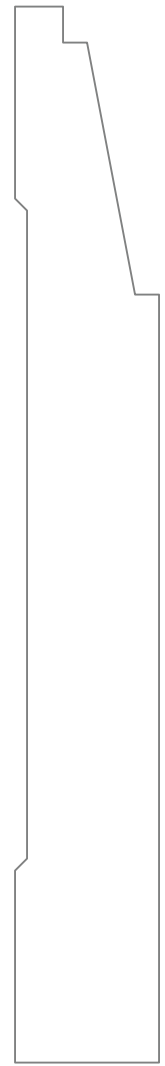

*PM-1664*

*PIERCE & PIERCE MILLWORK*

*FULL SCALE*



*PM-1666*



*PM-1605*



*PM-1670*



*PM-1672*

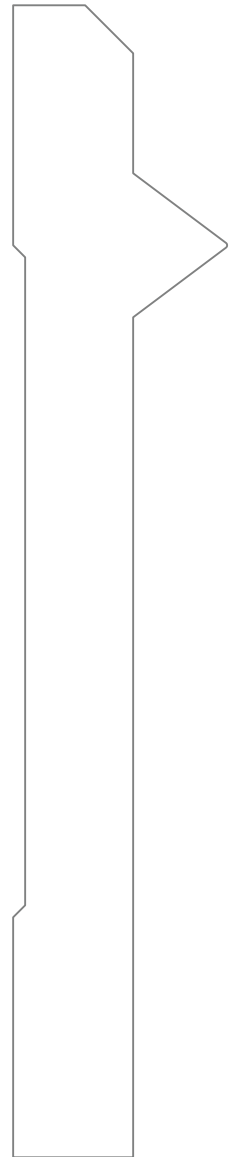

*PM-1673*

*PIERCE & PIERCE MILLWORK*

*FULL SCALE*

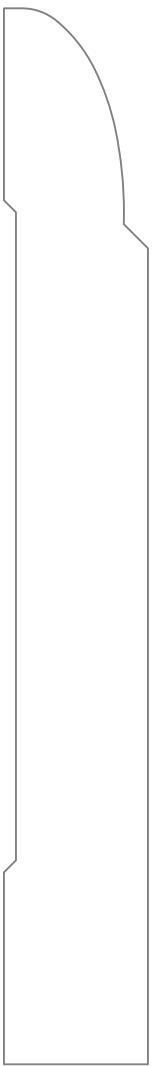

*PM-1675*

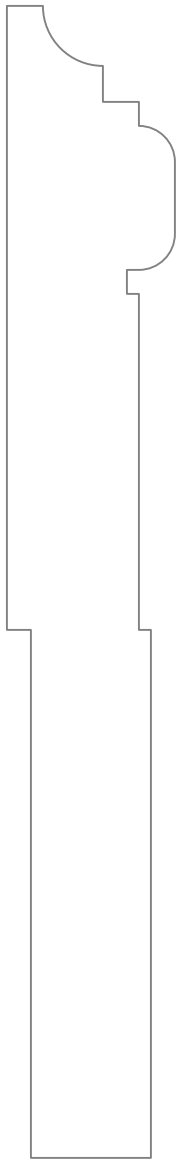

*PM-1602*

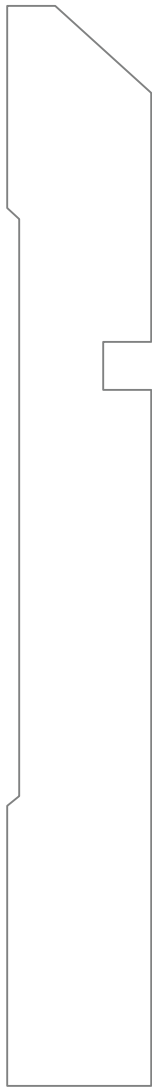

*PM-1604*



*PM-1607*



*PM-1609*

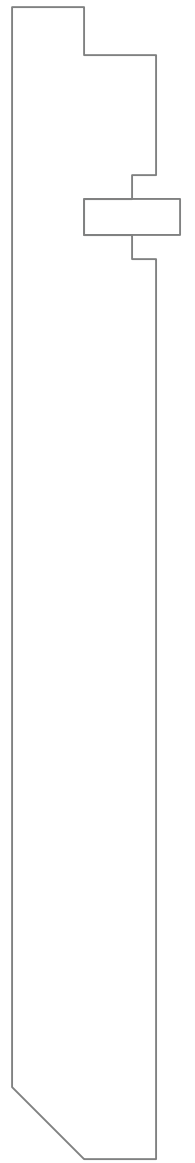

*PM-1610*

*PIERCE & PIERCE MILLWORK*

*FULL SCALE*

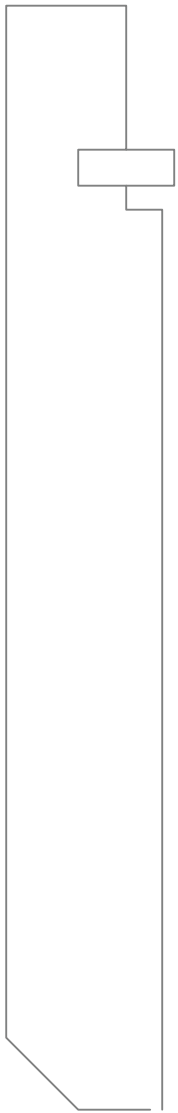

*PM-1611*



*PM-1621*

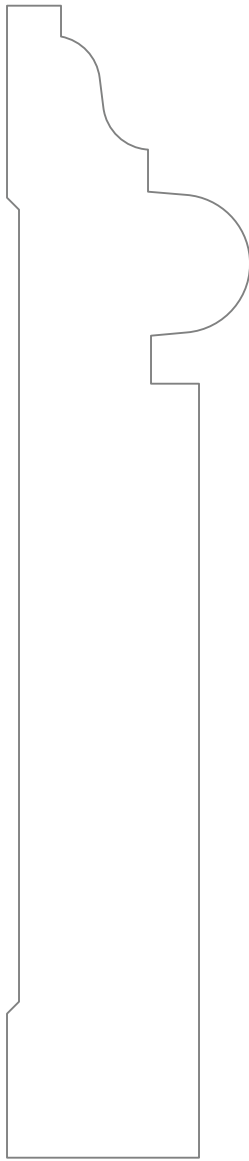

*PM-1624*



*PM-1627*

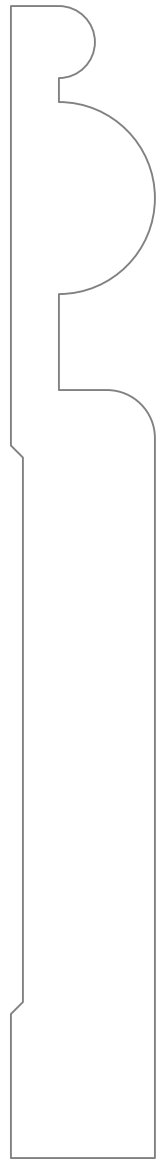

*PM-1632*

*PIERCE & PIERCE MILLWORK*

*FULL SCALE*

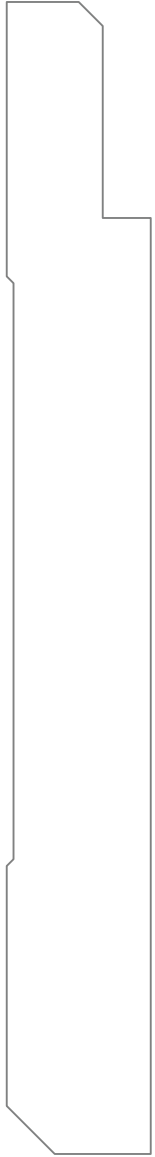

*PM-1636*



*PM-1639*



*PM-1654*

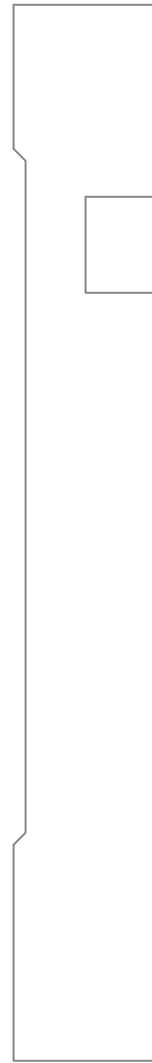

*PM-1650*

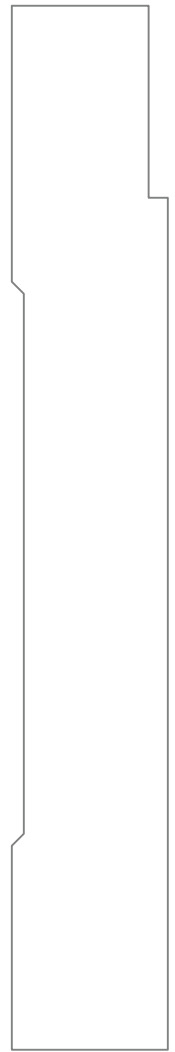

*PM-1651*

*PIERCE & PIERCE MILLWORK*

*FULL SCALE*

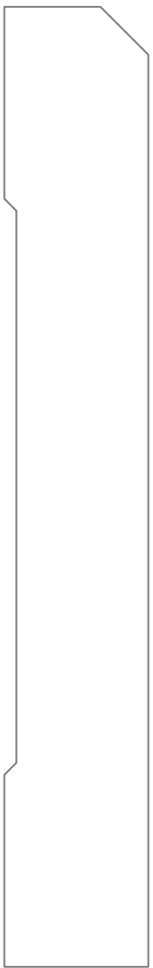

*PM-1669*



*PM-1656*



*PM-1628*

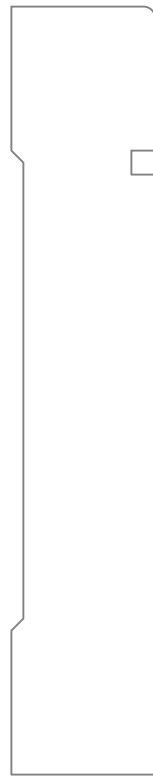

*PM-1613*



*PM-1615*



*PIERCE & PIERCE MILLWORK*

*FULL SCALE*

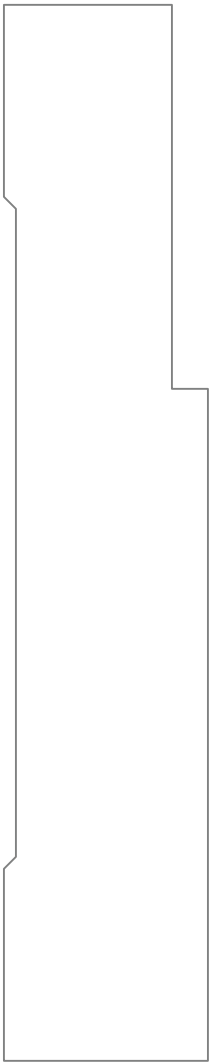

*PM-1616*

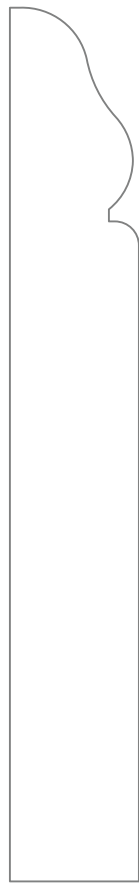

*PM-1623*



*PM-1625*



*PM-1626*

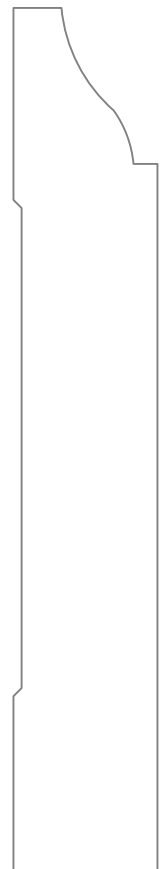

*PM-1629*

*PIERCE & PIERCE MILLWORK*

*FULL SCALE*

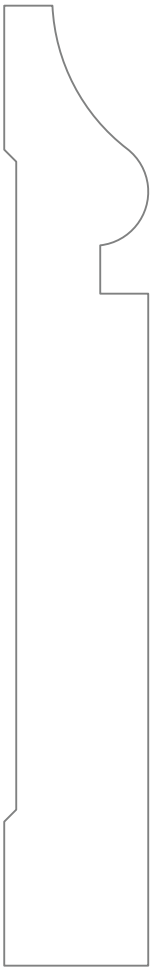

*PM-1630*



*PM-1631*



*PM-1634*

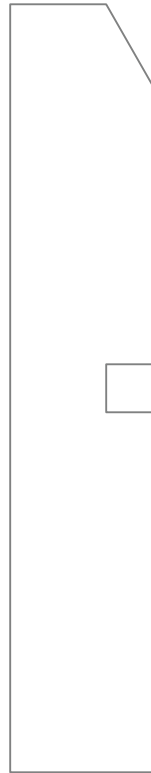

*PM-1637*



*PM-1638*

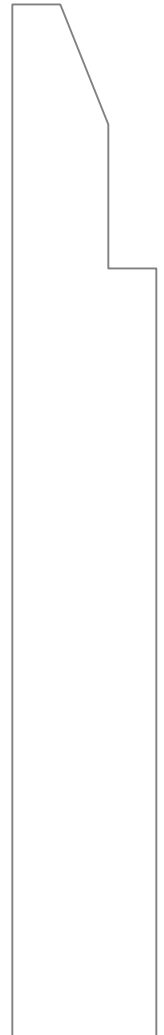

*PM-1645*

*PIERCE & PIERCE MILLWORK*

*FULL SCALE*

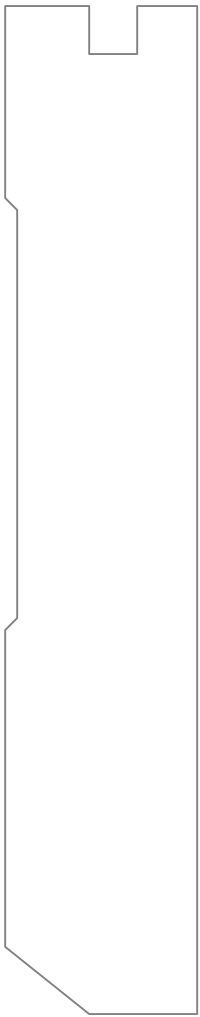

*PM-1646*



*PM-1648*



*PM-1655*

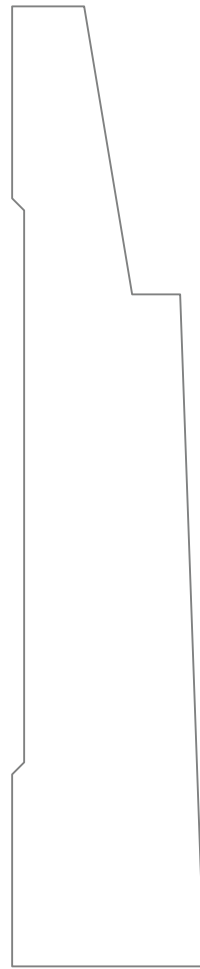

*PM-1657*

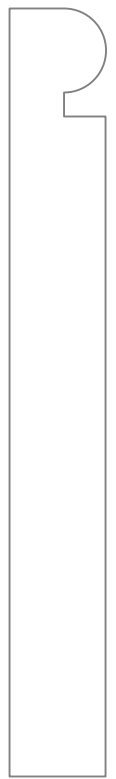

*PM-1671*

*PIERCE & PIERCE MILLWORK*

*FULL SCALE*

*PM-1667*

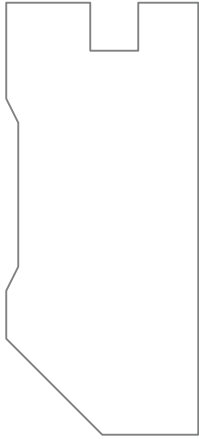

*PM-1668*

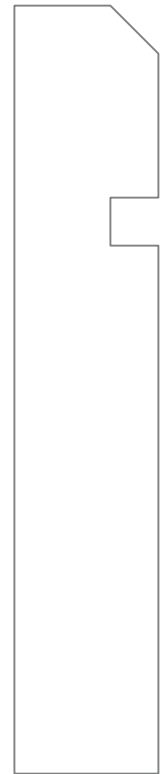
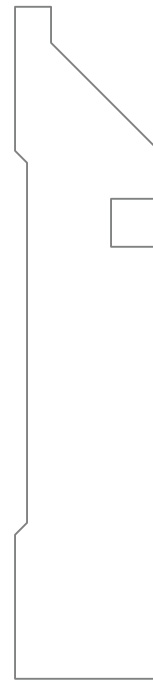
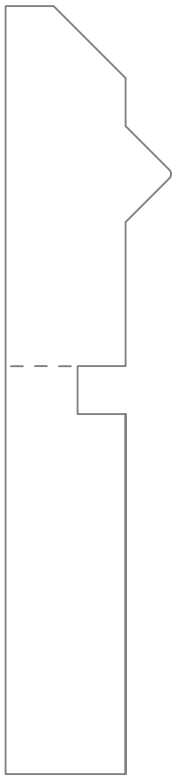

*PM-1674*

*PM-1659*

*PM-1661*

*PM-1665*

*PM-1649*

*PIERCE & PIERCE MILLWORK*

*FULL SCALE*

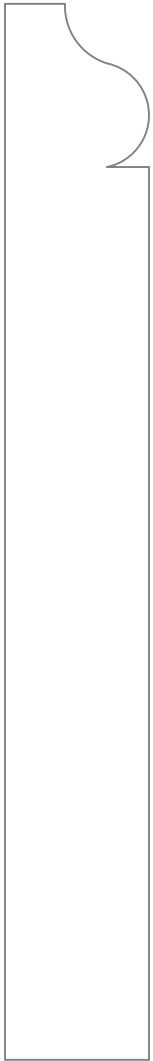

*PM-1723*



*PM-1710*



*PM-1715*

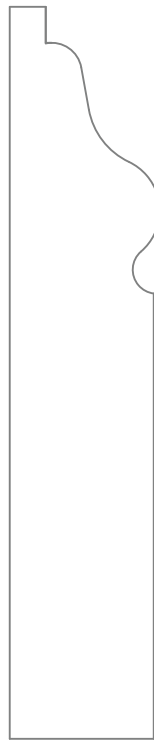

*PM-1717*

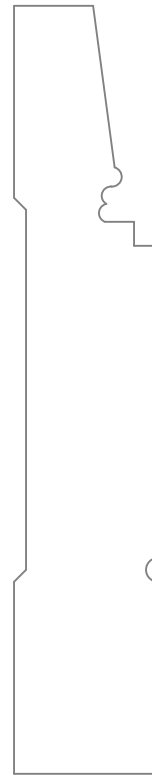

*PM-1718*



*PM-1724*

*PIERCE & PIERCE MILLWORK*

*FULL SCALE*

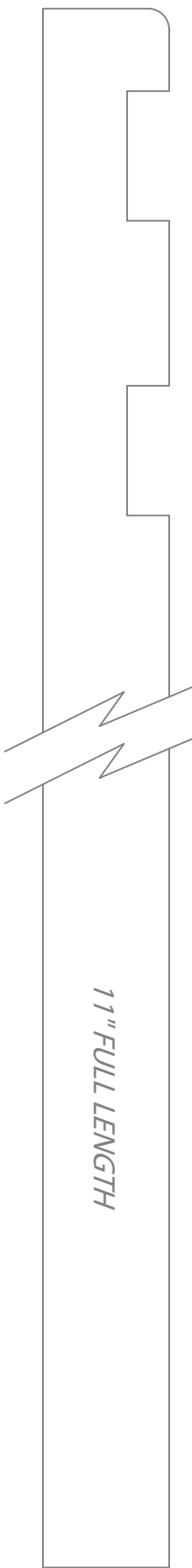

*11" FULL LENGTH*

*PM-1728*

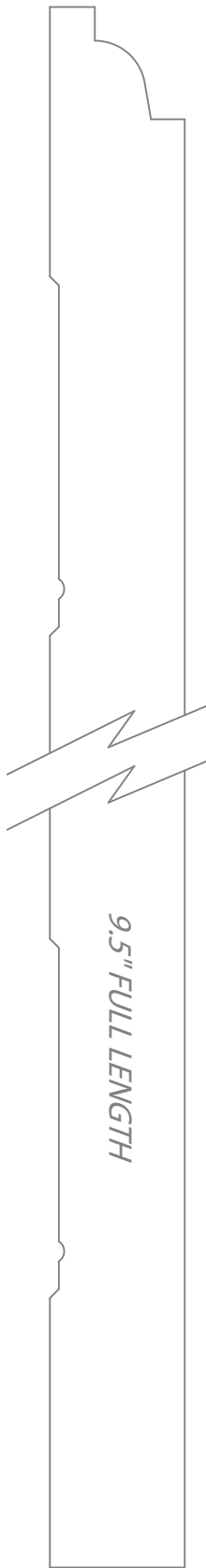

*9.5" FULL LENGTH*

*PM-1732*



*PM-1719*



*PM-1720*



*PM-1711*

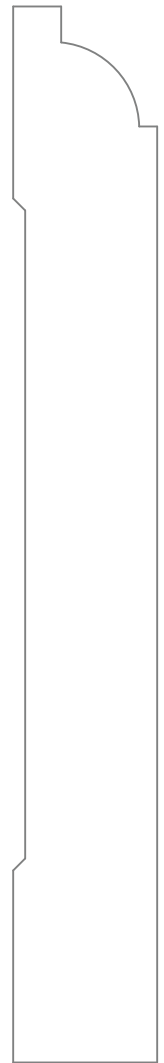

*PM-1734*

*PIERCE & PIERCE MILLWORK*

*FULL SCALE*

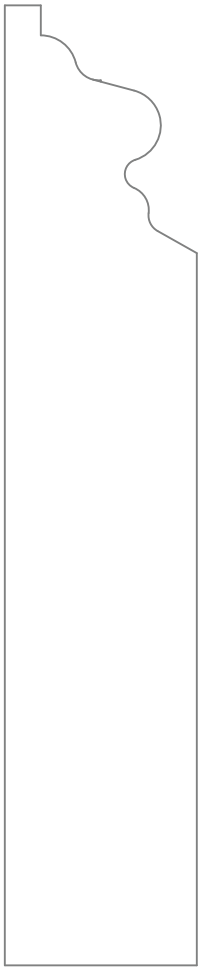

*PM-1730*



*PM-1755*

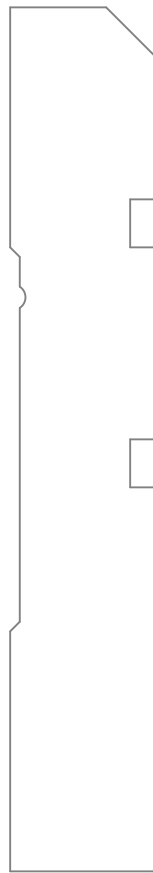

*PM-1746*



*PM-1733*

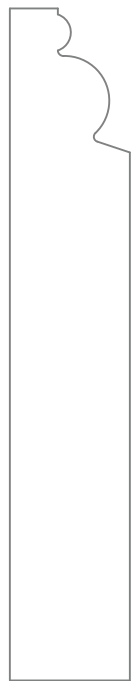

*PM-1736*

*PIERCE & PIERCE MILLWORK*

*FULL SCALE*



*PM-1753*



*PM-1757*



*PM-1740*



*PM-1750*

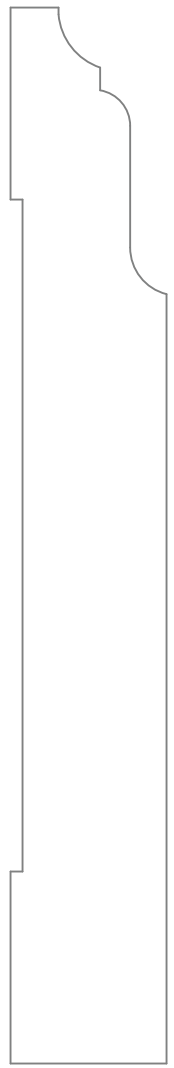

*PM-1735*



# PIERCE & PIERCE MILLWORK

FULL SCALE



*PM-2003*

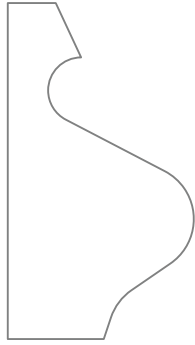

*PM-2004*



*PM-2005*



*PM-2006*

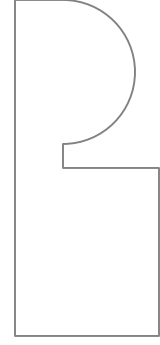

*PM-2007*

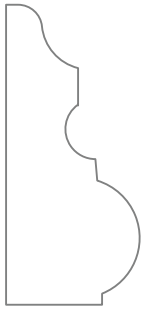

*PM-2009*

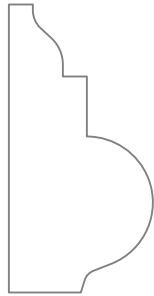

*PM-2010*



*PM-2011*

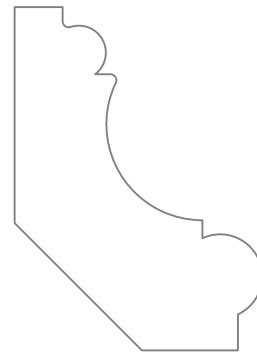

*PM-2012*

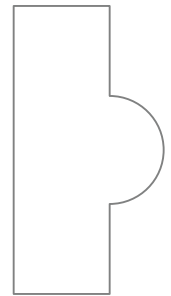

*PM-2013*

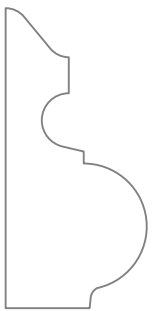

*PM-2016*

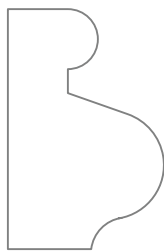

*PM-2017*



*PM-2018*



*PM-2019*



*PM-2020*

# PIERCE & PIERCE MILLWORK

FULL SCALE

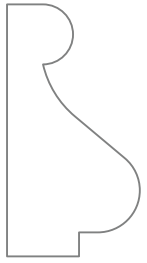

PM-2021



PM-2022

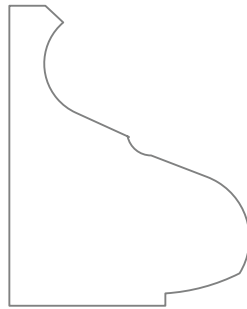

PM-2023



PM-2024

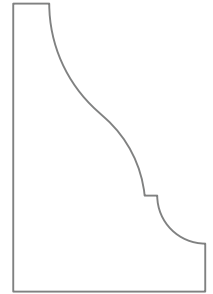

PM-2025

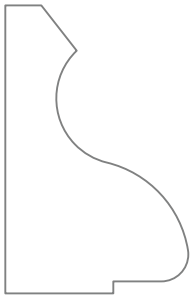

PM-2026

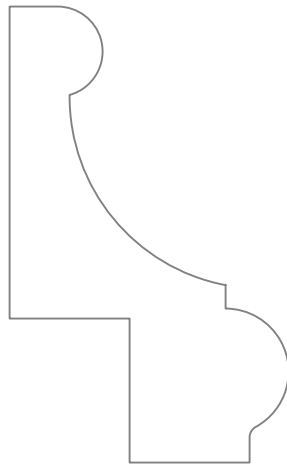

PM-2028

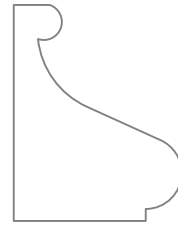

PM-2030



PM-2031

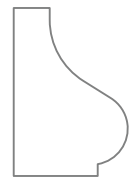

PM-2032

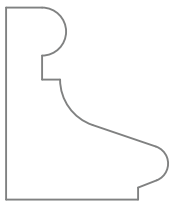

PM-2033

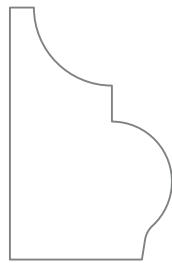

PM-2034



PM-2035



PM-2036



PM-2037

# PIERCE & PIERCE MILLWORK

FULL SCALE

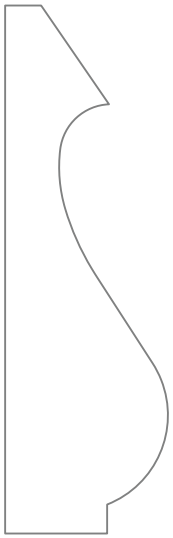

PM-2038

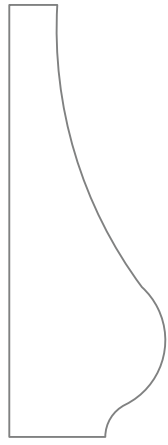

PM-2039

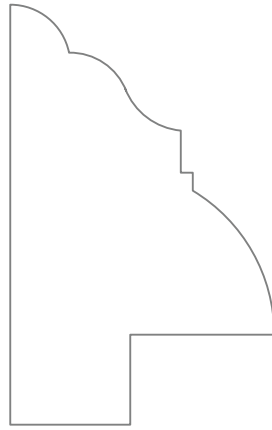

PM-2051



PM-2048

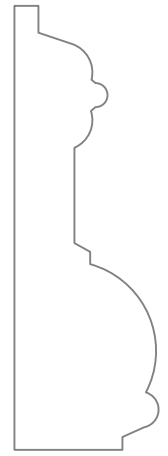

PM-2045

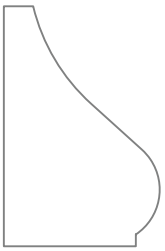

PM-2041



PM-2046

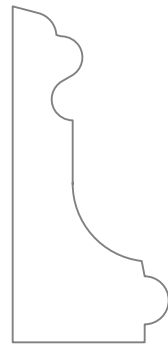

PM-2047



PM-2049



PM-2050

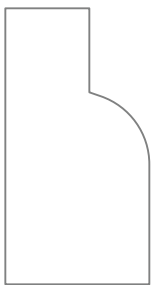

PM-2040

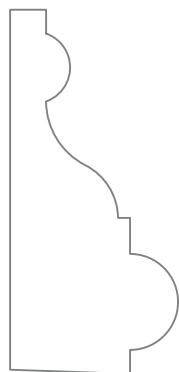

PM-2052

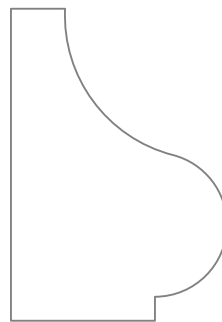

PM-2053

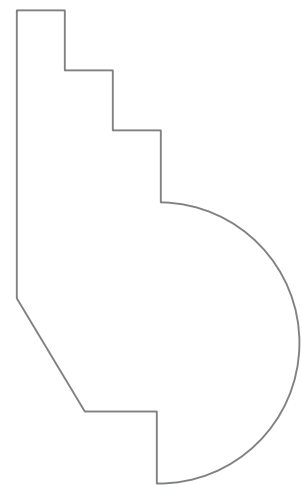

PM-2055

# PIERCE & PIERCE MILLWORK

FULL SCALE

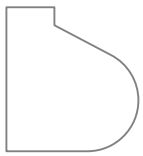

PM-2057

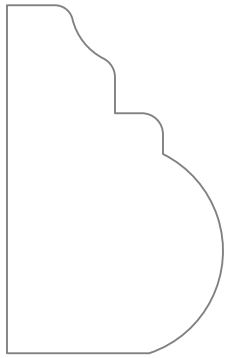

PM-2058

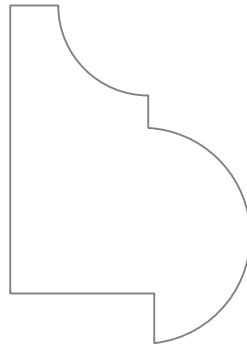

PM-2059

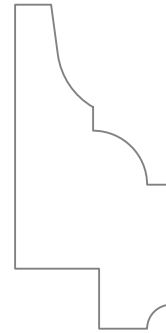

PM-2060



PM-2061

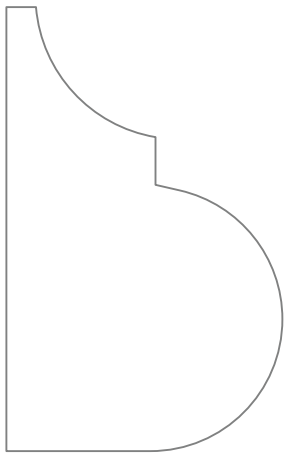

PM-2062

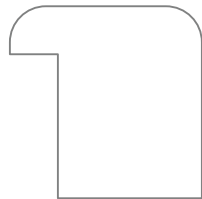

PM-2063

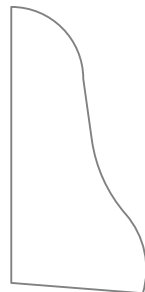

PM-2064

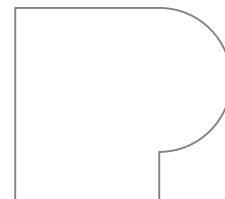

PM-2066



PM-2067

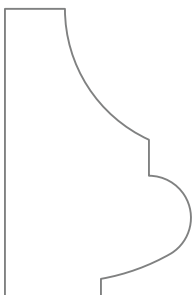

PM-2069



PM-2070



PM-2071



PM-2072



PM-2073

*PIERCE & PIERCE MILLWORK*

*FULL SCALE*

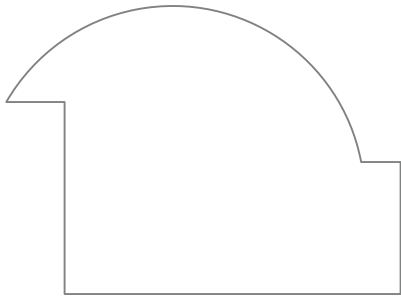

*PM-2076*



*PM-2081*



*PM-2084*



*PM-2088*



*PM-2099*

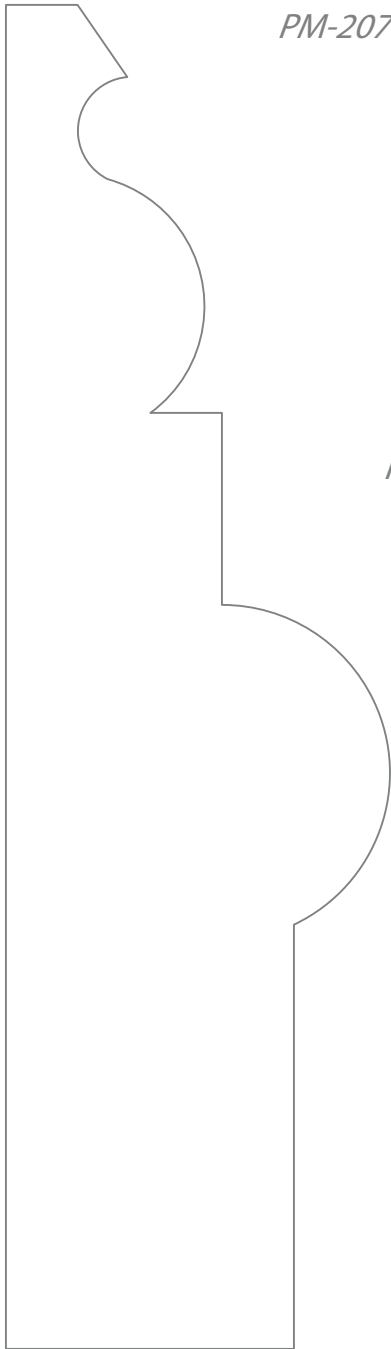

*PM-2075*

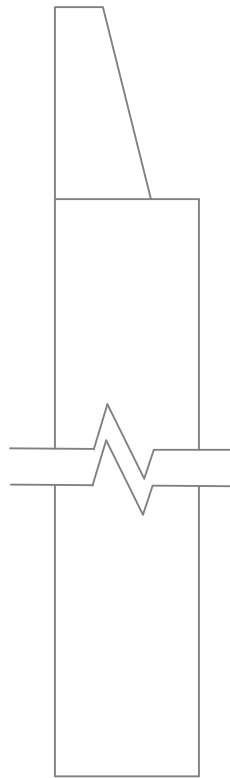

*PM-2080*

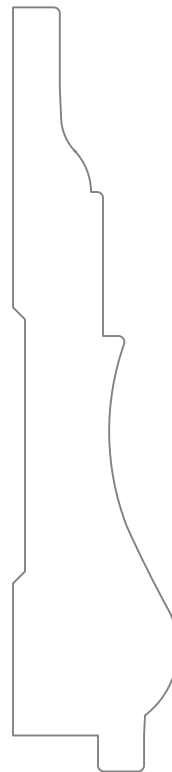

*PM-2098*

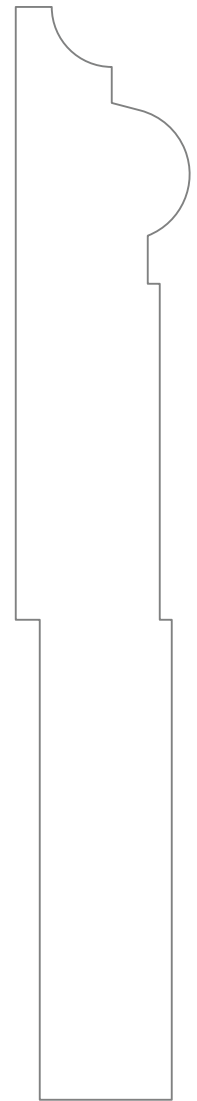

*PM-2085*

# PIERCE & PIERCE MILLWORK

FULL SCALE



PM-2074



PM-2077



PM-2078



PM-2082



PM-2083

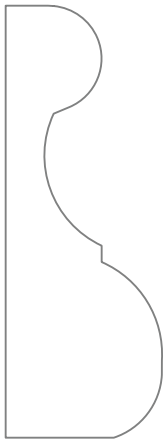

PM-2079

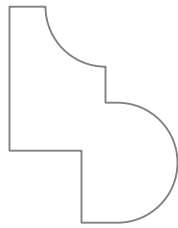

PM-2086

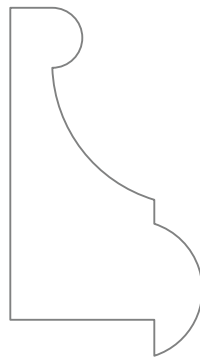

PM-2087



PM-2089

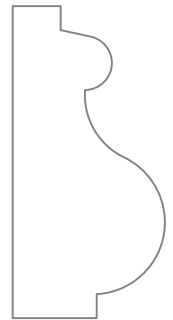

PM-2090

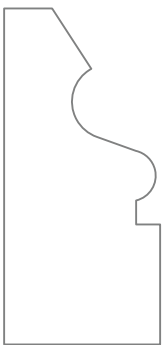

PM-2091

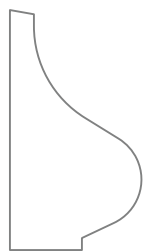

PM-2092



PM-2093



PM-2094

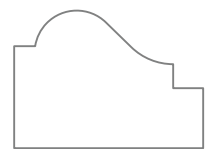

PM-2095

*PIERCE & PIERCE MILLWORK*

*FULL SCALE*

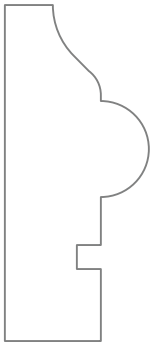

*PM-2100*

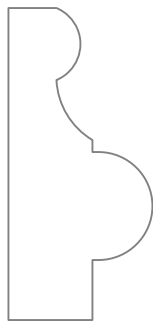

*PM-2101*



*PM-2102*

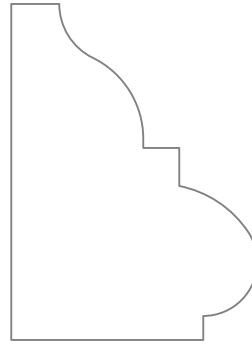

*PM-2103*

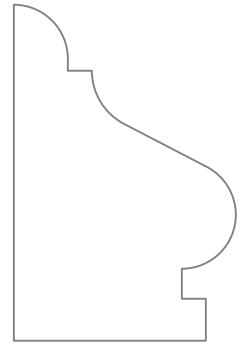

*PM-2104*

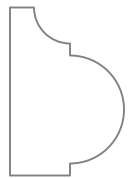

*PM-2105*

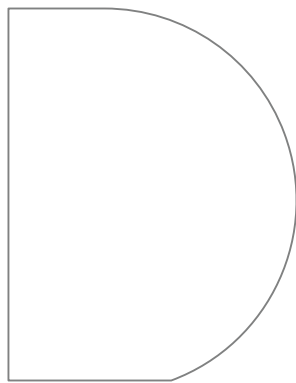

*PM-2107*



*PM-2108*



*PM-2109*

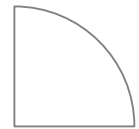

*PM-2110*

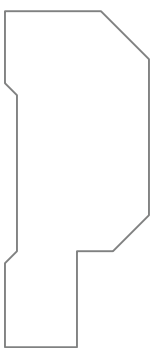

*PM-2111*



*PM-2112*

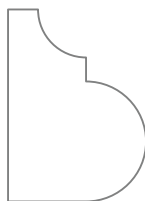

*PM-2113*



*PM-2114*

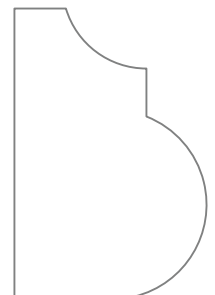

*PM-2115*

# PIERCE & PIERCE MILLWORK

FULL SCALE

SAME AS SBC-2

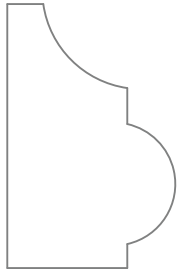

PM-2117

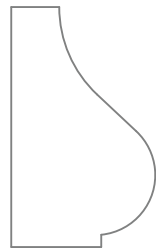

PM-2120



PM-2121

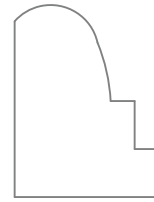

PM-2122

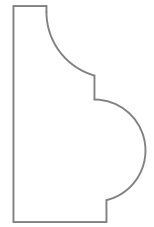

PM-2144

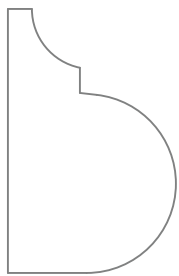

PM-2123



PM-2127



PM-2129



PM-2130

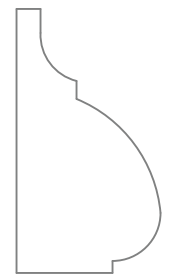

PM-2135

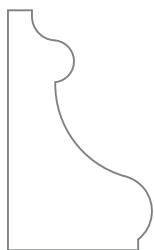

PM-2138

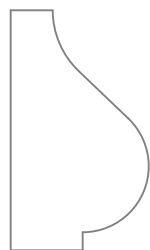

PM-2149

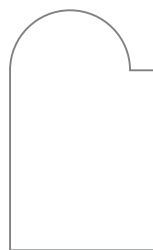

PM-2136



PM-2147



PM-2146



PM-2150

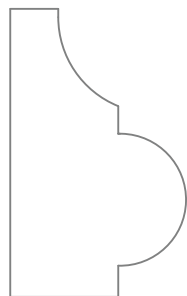

PM-2145

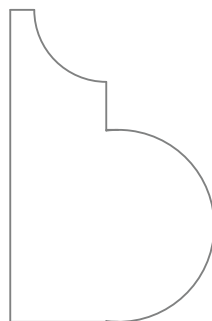

PM-2137



PM-2125

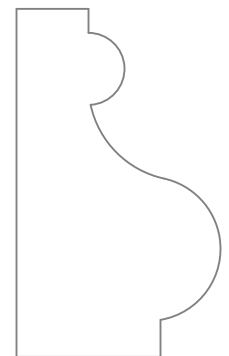

PM-2132



*PIERCE & PIERCE MILLWORK*

*FULL SCALE*

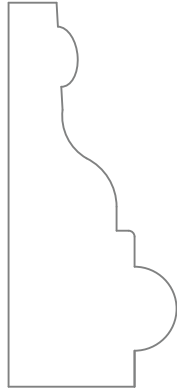

*PM-2131*

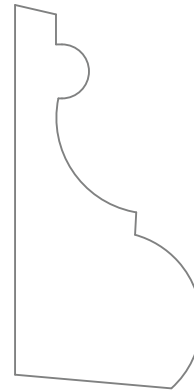

*PM-2140*

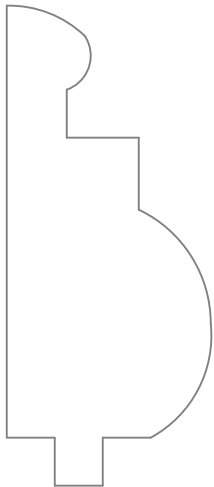

*PM-2133*

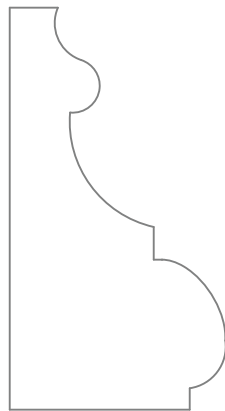

*PM-2141*

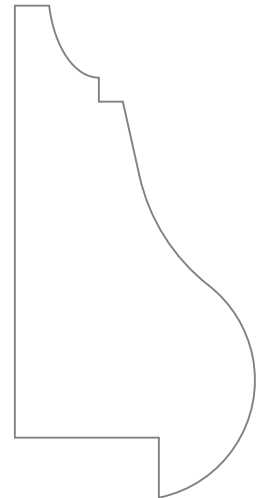

*PM-2119*

*PIERCE & PIERCE MILLWORK*

*FULL SCALE*

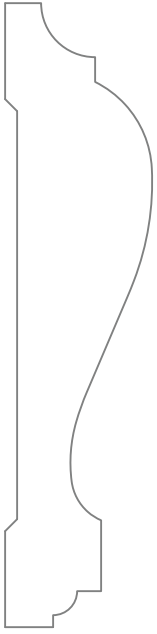

*PM-2522*

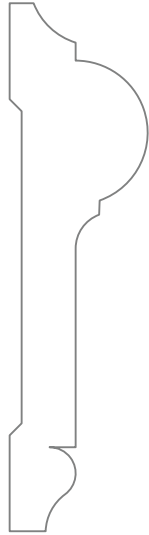

*PM-2528*

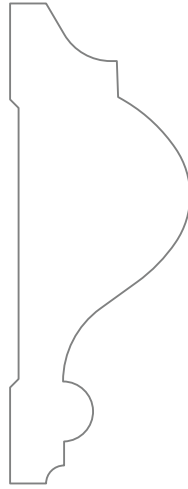

*PM-2529*



*PM-2530*

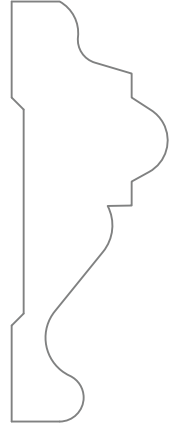

*PM-2532*

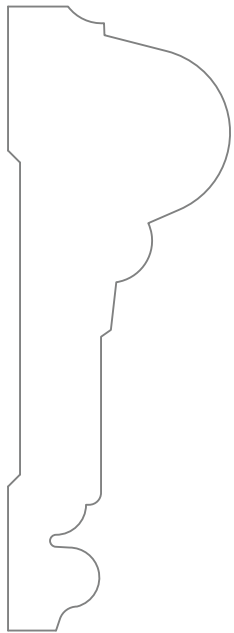

*PM-2543*



*PM-2544*

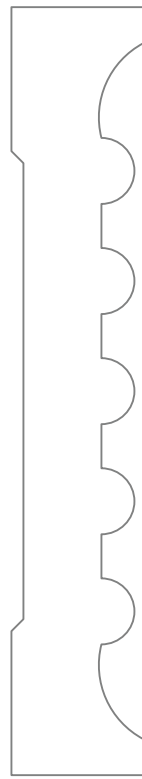

*PM-2545*



*PM-2546*

*PIERCE & PIERCE MILLWORK*

*FULL SCALE*

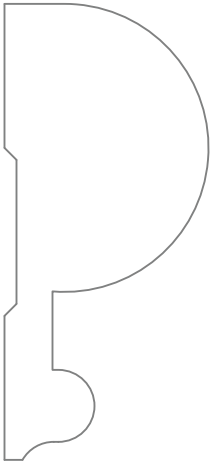

*PM-2533*



*PM-2535*



*PM-2537*

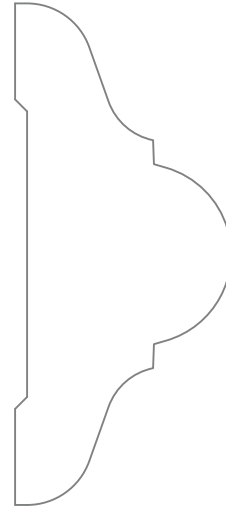

*PM-2540*

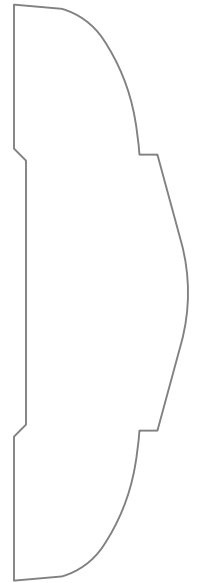

*PM-2542*

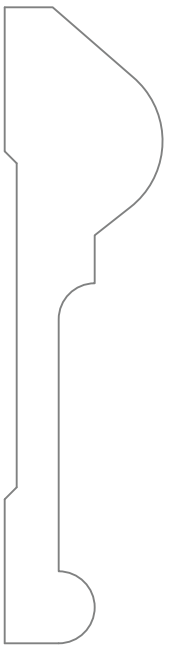

*PM-2547*



*PM-2548*

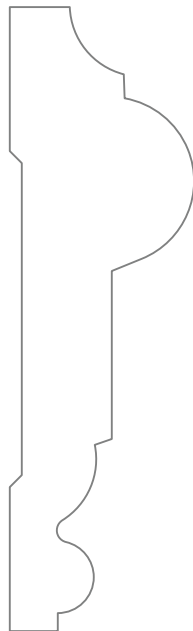

*PM-2549*



*PM-2550*

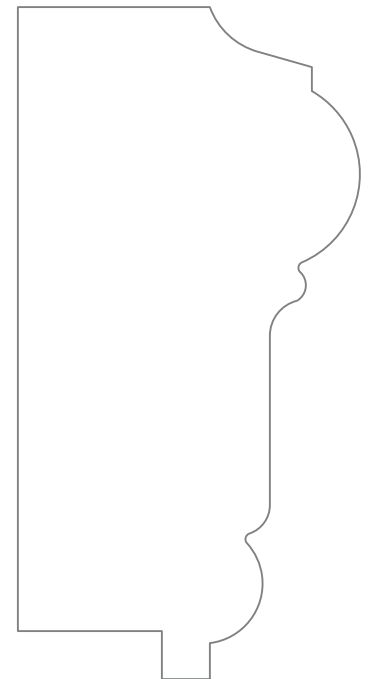

*PM-2551*

*PIERCE & PIERCE MILLWORK*

*FULL SCALE*

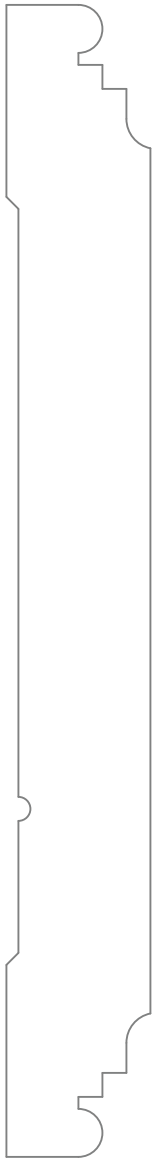

*PM-2576*

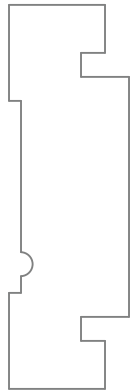

*PM-2505*

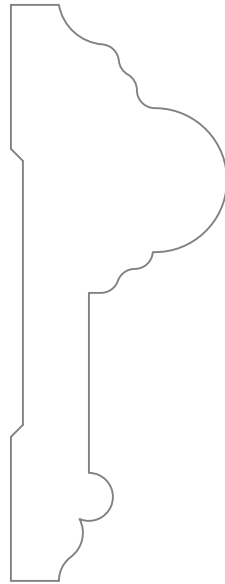

*PM-2538*

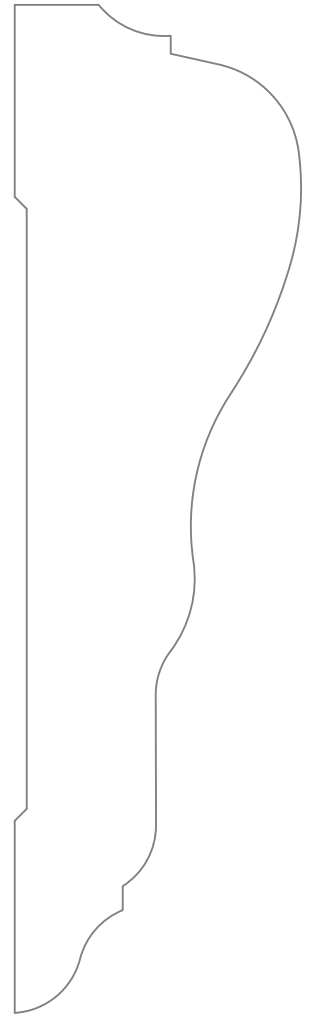

*PM-2559*



*PM-2501*



*PM-2595*

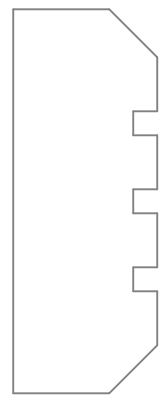

*PM-2598*

*PIERCE & PIERCE MILLWORK*

*FULL SCALE*

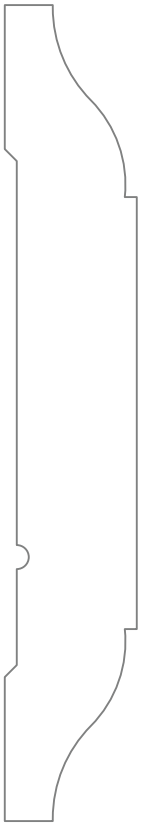

*PM-2552*



*PM-2553*

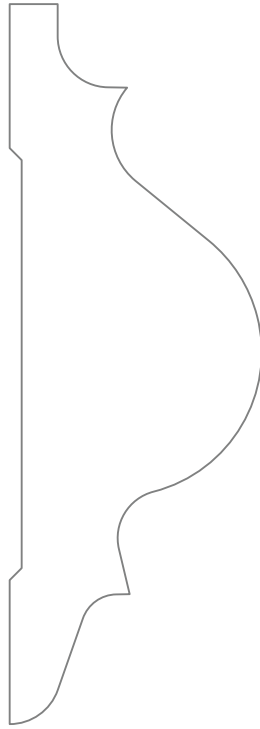

*PM-2554*

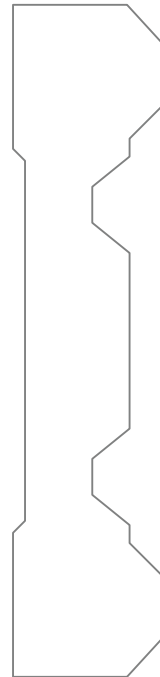

*PM-2556*

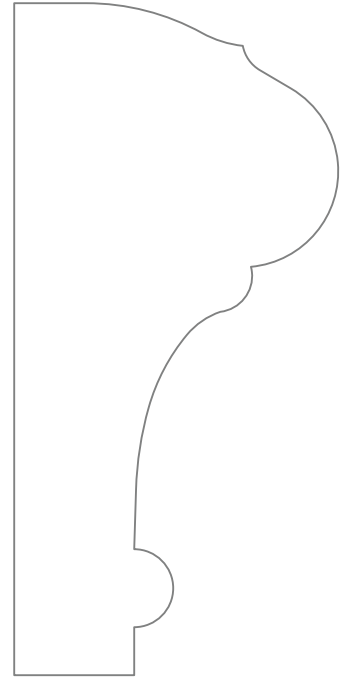

*PM-2557*

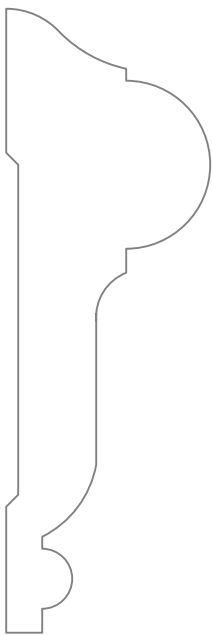

*PM-2582*

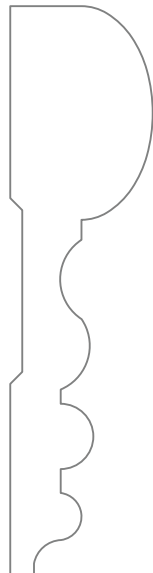

*PM-2585-E*

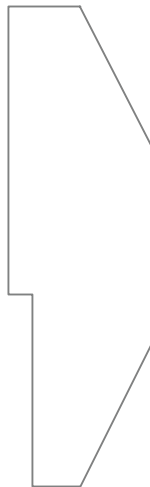

*PN-2594*

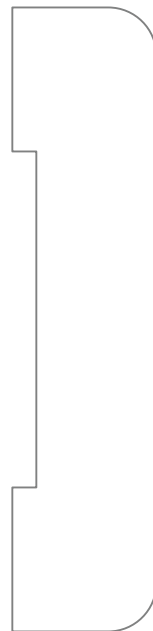

*PM-2596*



*PM-2599*

*PIERCE & PIERCE MILLWORK*

*FULL SCALE*

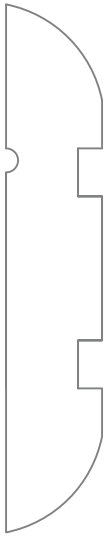

*PM-2600*



*PM-2601*



*PM-2603*



*PM-2604*

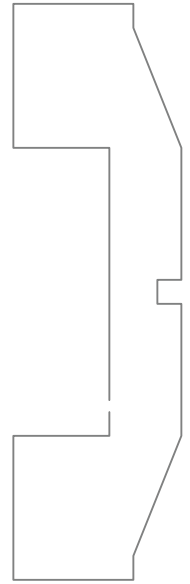

*PM-2605*

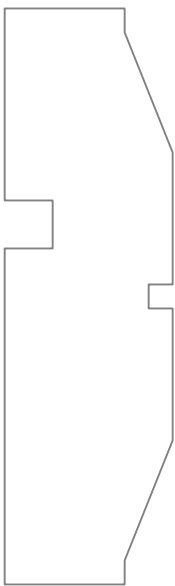

*PM-2606*



*PM-2607*

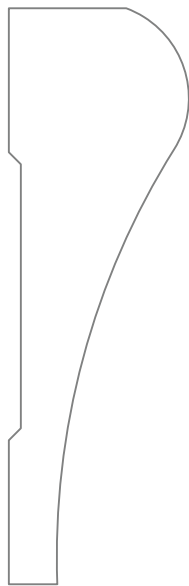

*PM-2609*

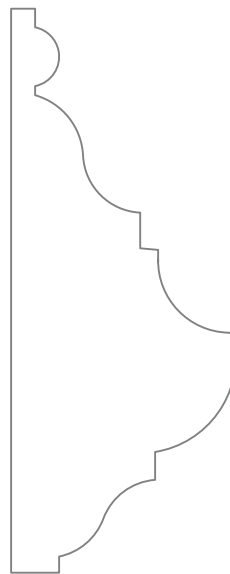

*PM-2610*

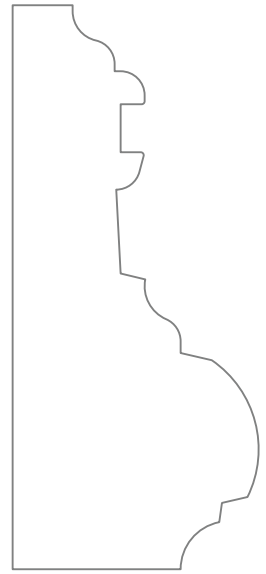

*PM-2611*

*PIERCE & PIERCE MILLWORK*

*FULL SCALE*

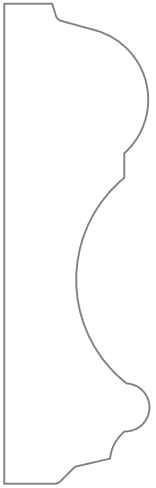

*PM-2617*



*PM-2624*

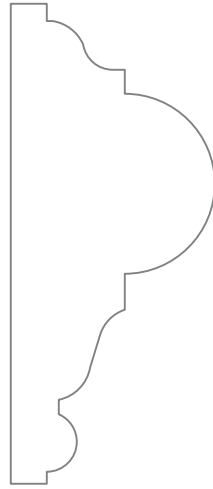

*PM-2629*

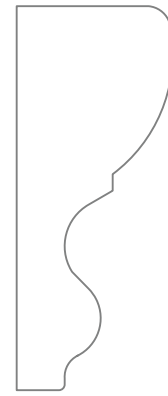

*PM-2635*

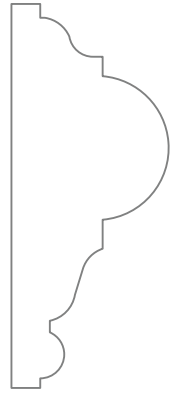

*PM-2642*

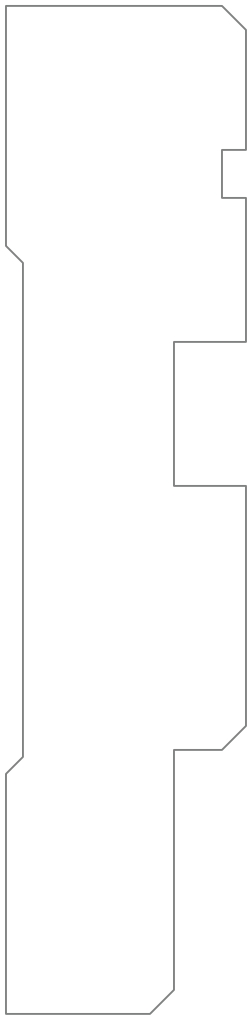

*PM-2602*

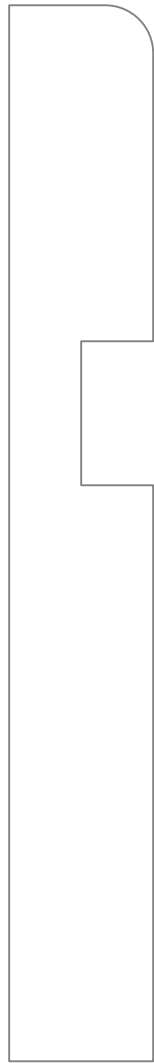

*PM-2616*



*PM-2618*

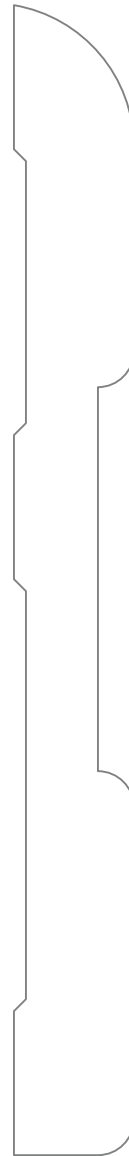

*PM-2613*

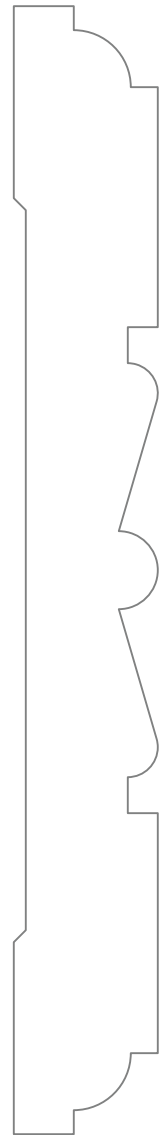

*PM-2608*

*PIERCE & PIERCE MILLWORK*

*FULL SCALE*

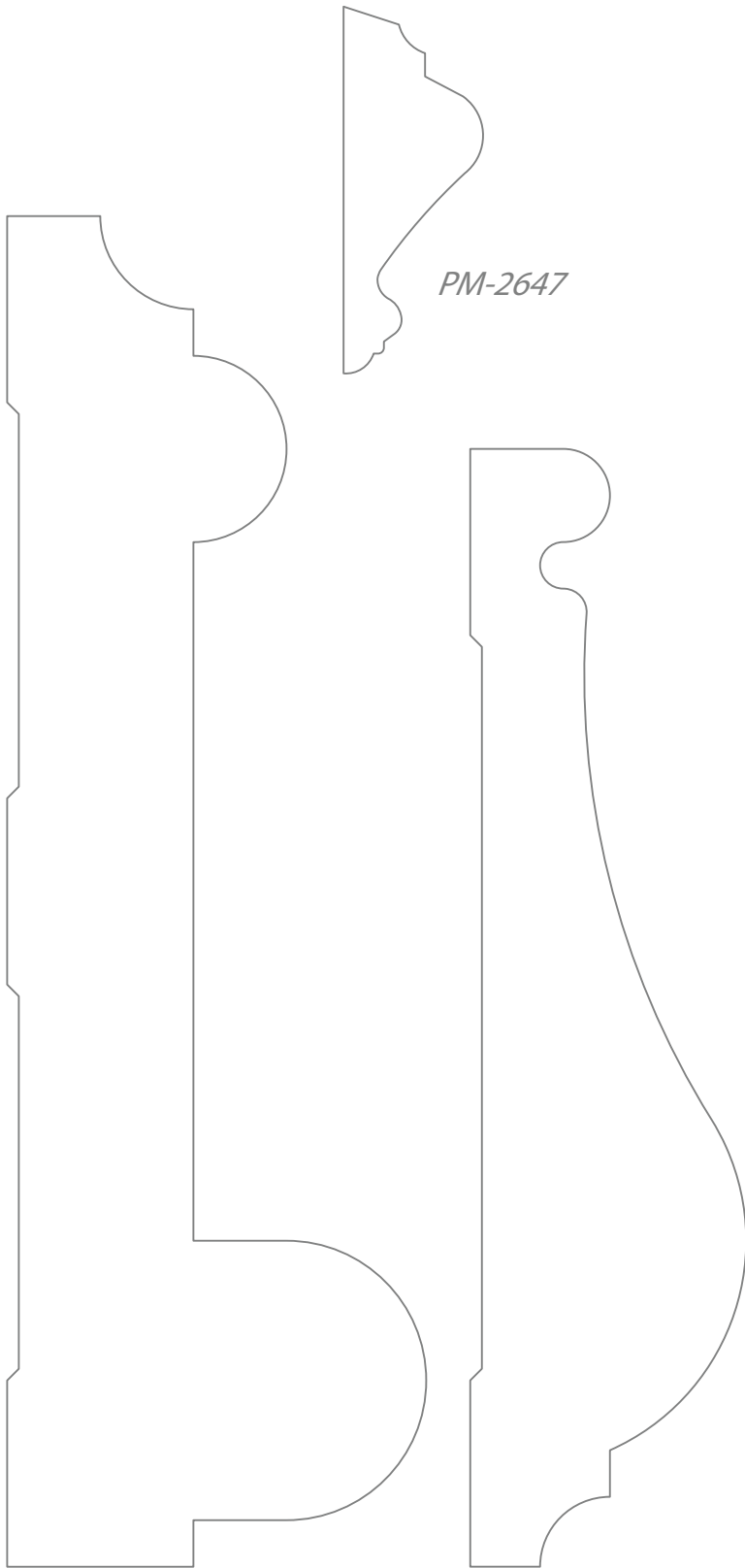

*PM-2647*

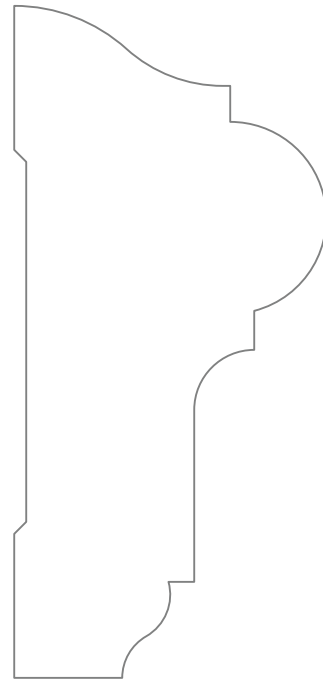

*PM-2643*

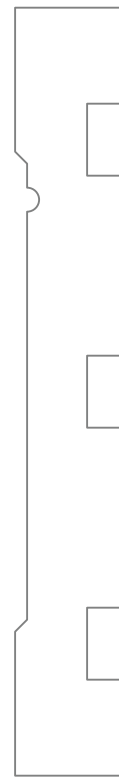

*PM-2636*

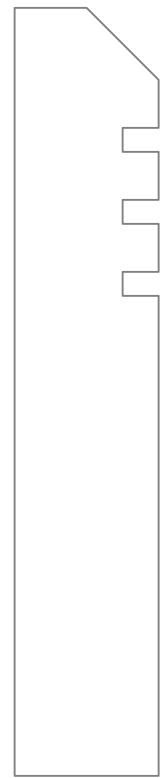

*PM-2612*

*PM-2626*

*PM-2627*



*PIERCE & PIERCE MILLWORK*

*FULL SCALE*

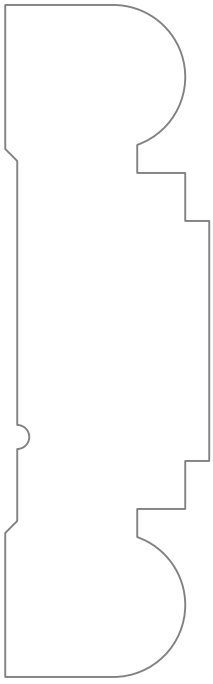

*PM-2614*

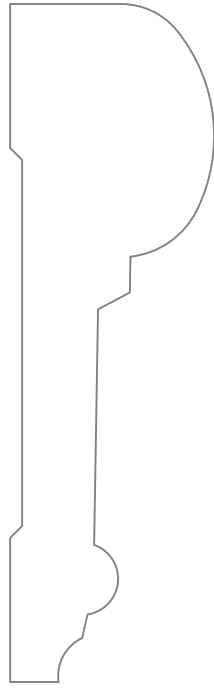

*PM-2615*

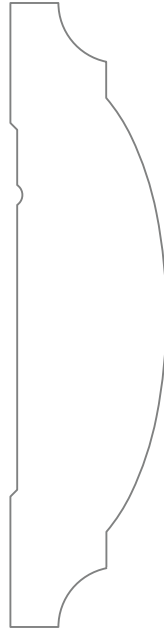

*PM-2620*

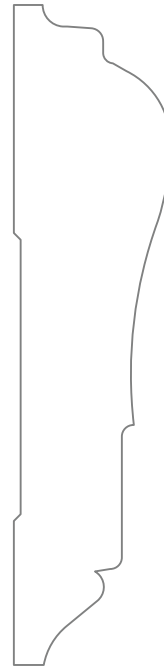

*PM-2623*



*PM-2632*

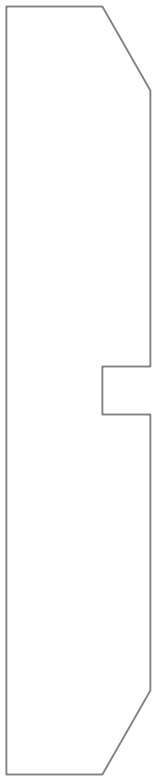

*PM-2619*

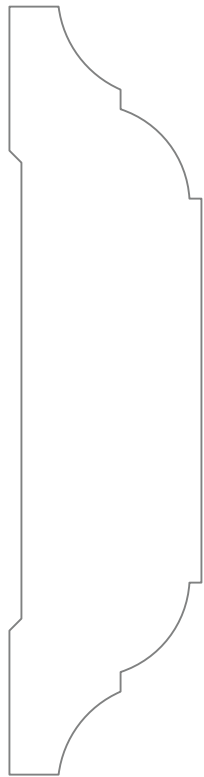

*PM-2631*

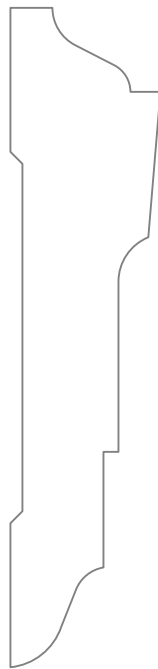

*PM-2641*

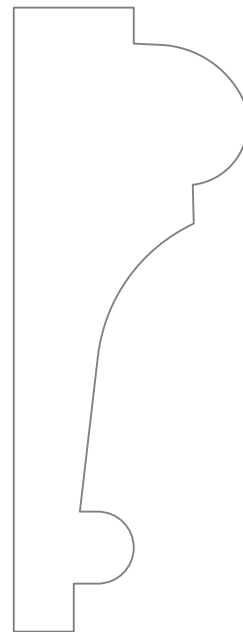

*PM-2644*

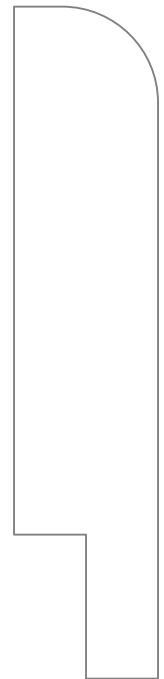

*PM-2646*

*PIERCE & PIERCE MILLWORK*

*FULL SCALE*

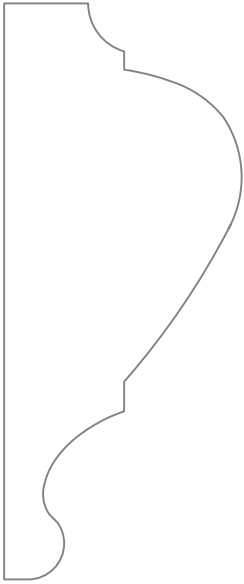

*PM-2628*



*PM-2633*



*PM-2634*

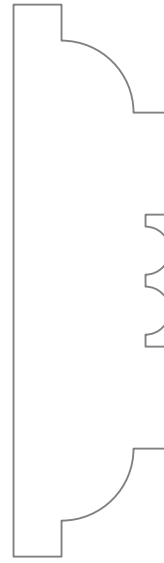

*PM-2637*

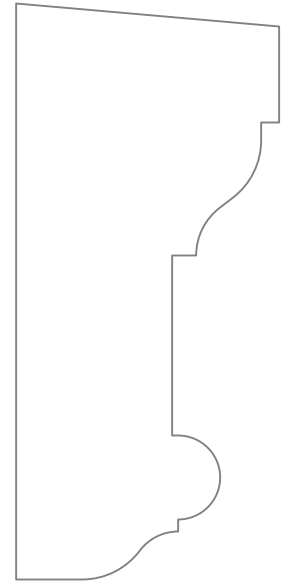

*PM-2638*



*PM-2639*

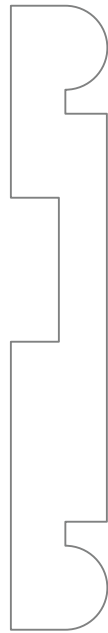

*PM-2640*

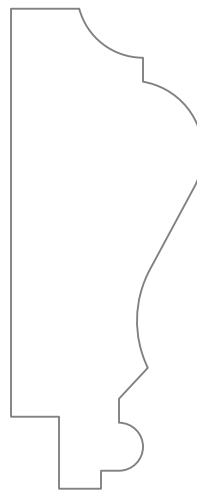

*PM-2645*

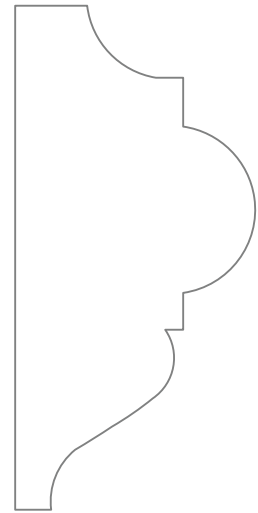

*PM-2648*

*PIERCE & PIERCE MILLWORK*

*FULL SCALE*

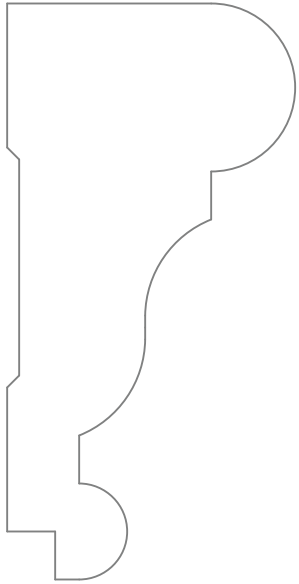

*PM-2649*

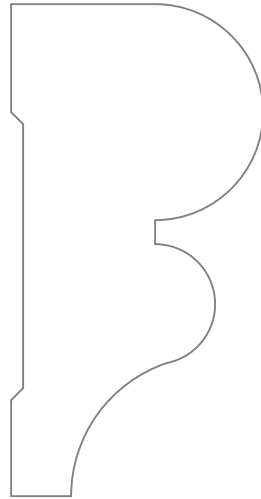

*PM-2650*

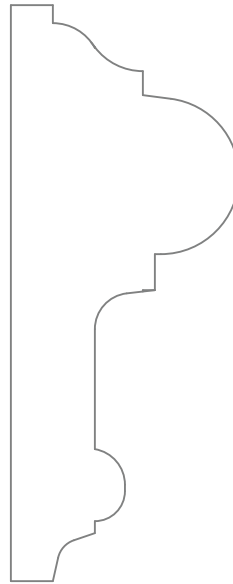

*PM-2678*

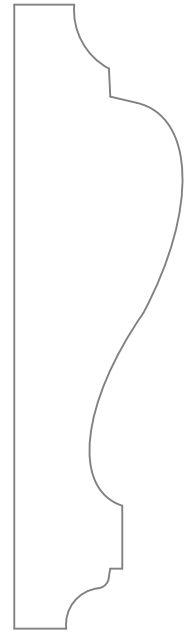

*PM-2659*

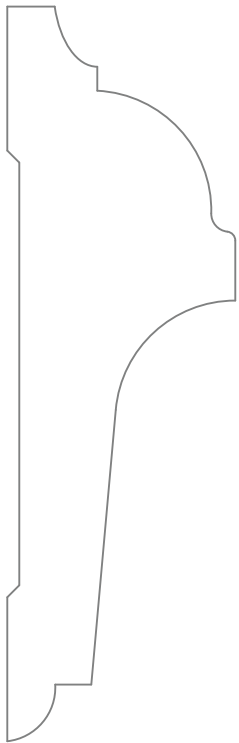

*PM-2654*

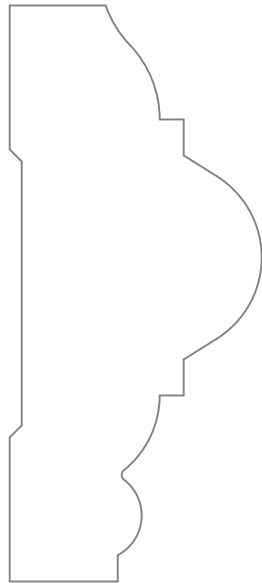

*PM-2656*

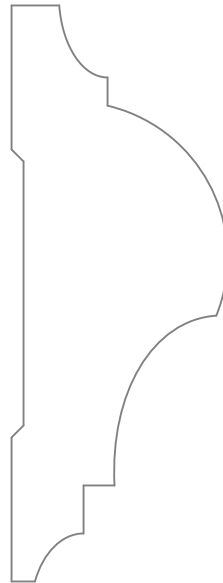

*PM-2653*

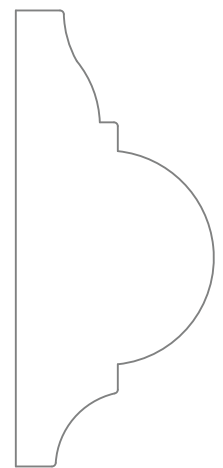

*PM-2651*

*PIERCE & PIERCE MILLWORK*

*FULL SCALE*

*PM-9651B*

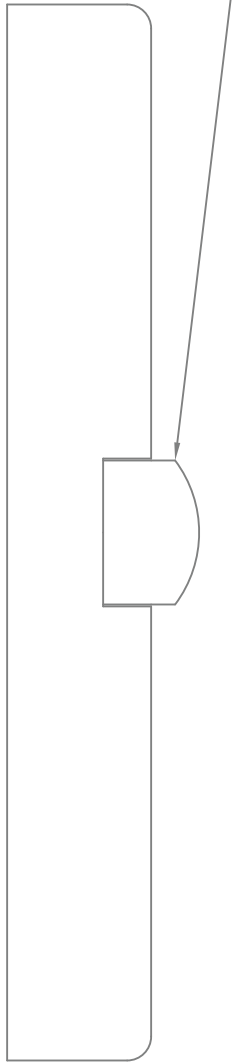

*PM-2671*

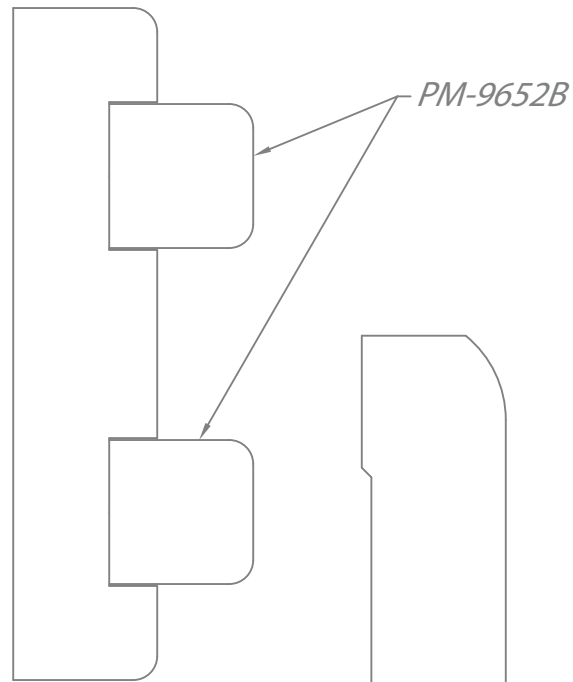

*PM-2672*

*PM-9652B*

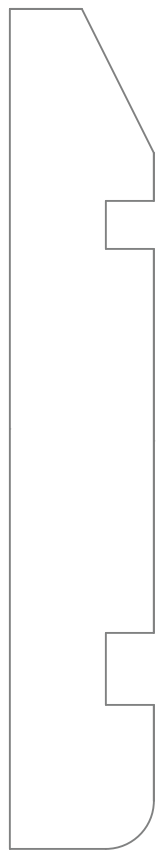

*PM-2661*



*PM-2676*



*PM-2660*

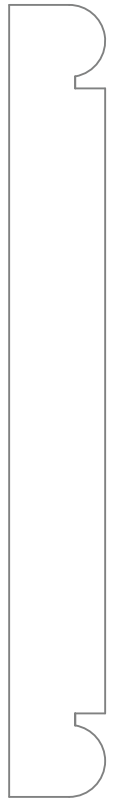

*PM-2666*

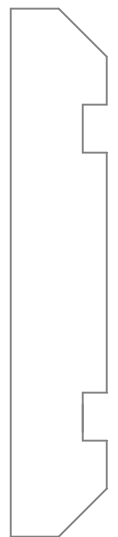

*PM-2662*

*PIERCE & PIERCE MILLWORK*

*FULL SCALE*

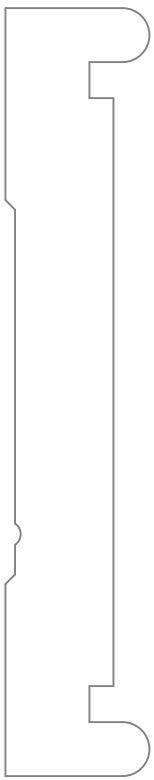

*PM-2677*



*PM-2679*



*PM-2683*

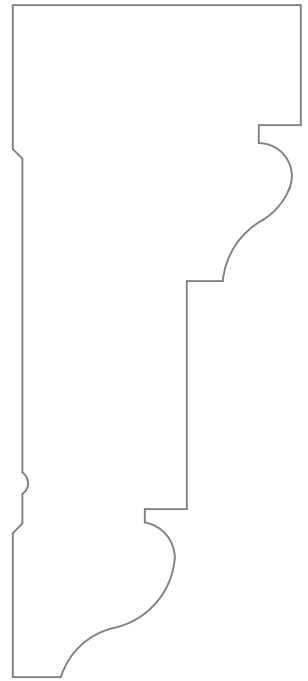

*PM-2680*



*PM-2669*

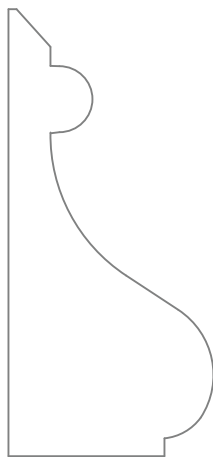

*PM-2663*



*PM-2682*

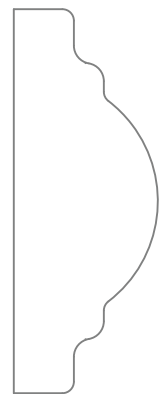

*PM-2686*

# PIERCE & PIERCE MILLWORK

FULL SCALE

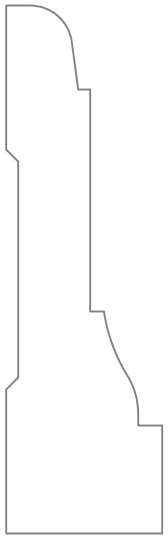

*PM-3001*

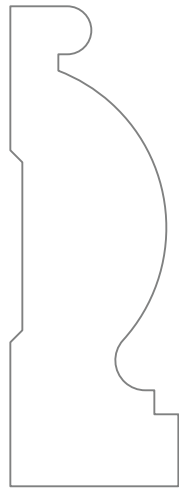

*PM-3002*



*PM-3014*

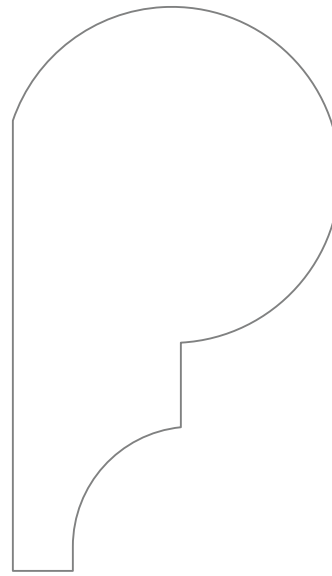

*PM-3051*

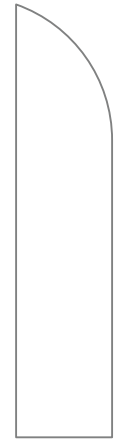

*PM-3093*

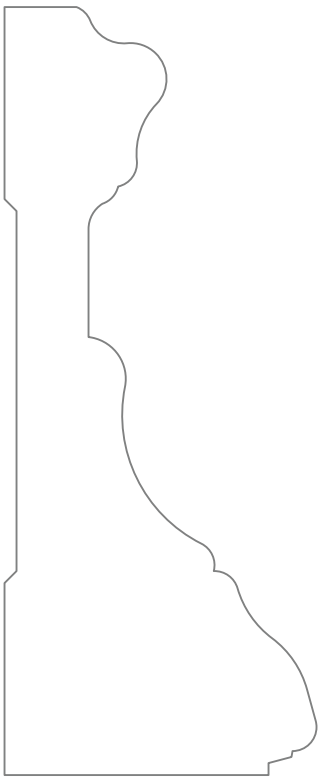

*PM-3007*



*PM-3008*



*PM-3009*



*PM-3010*

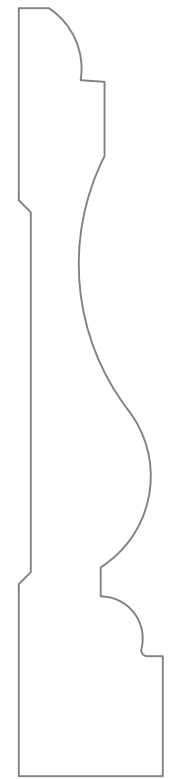

*PM-3011*

*PIERCE & PIERCE MILLWORK*

*FULL SCALE*

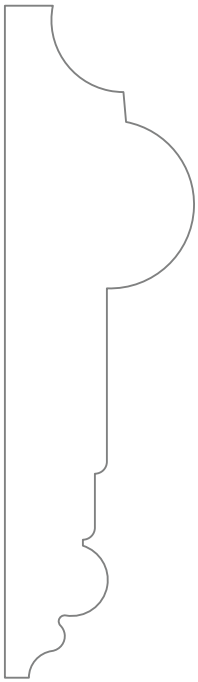

*PM-3012*



*PM-3013*

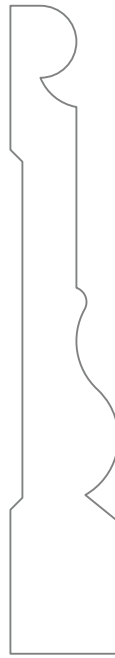

*PM-3017*

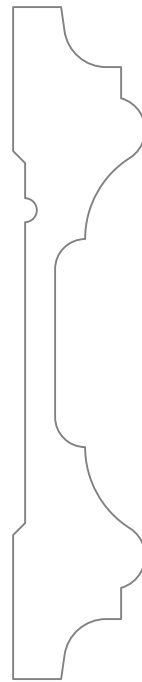

*PM-3019*

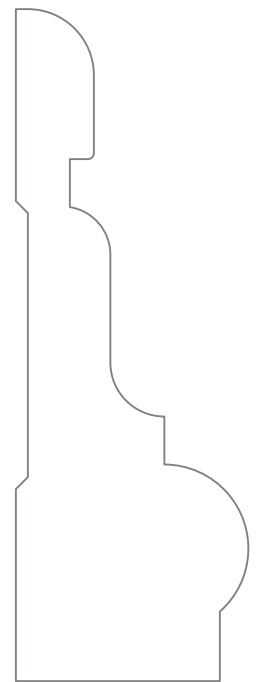

*PM-3020*

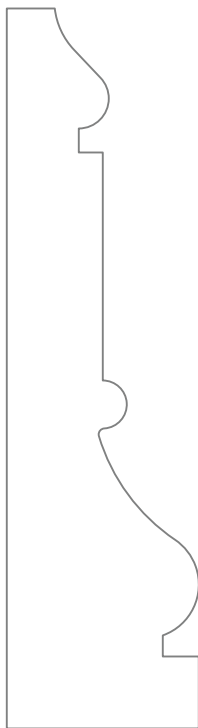

*PM-3025*

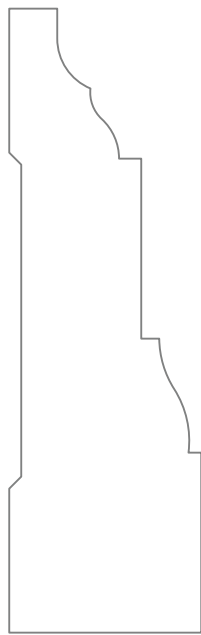

*PM-3030*



*PM-3045*

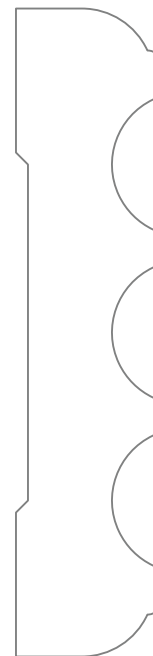

*PM-3049*

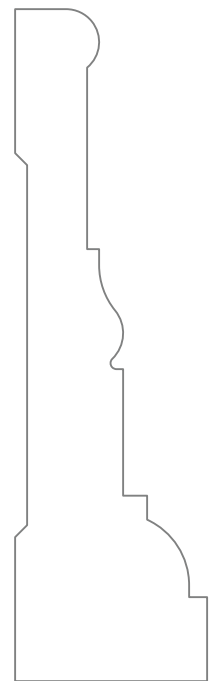

*PM-3050*

# PIERCE & PIERCE MILLWORK

FULL SCALE

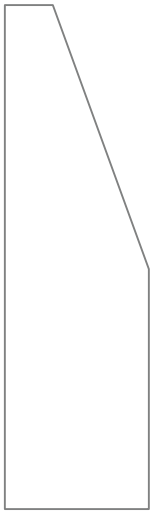

PM-3132

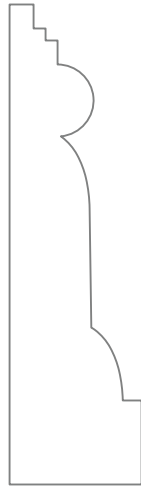

PM-3135

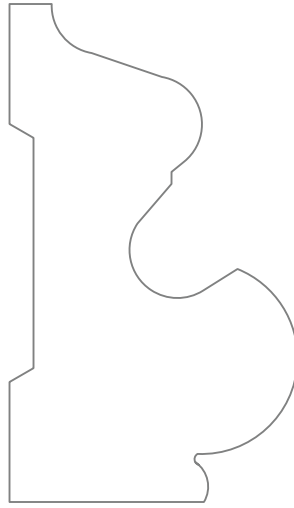

PM-3136

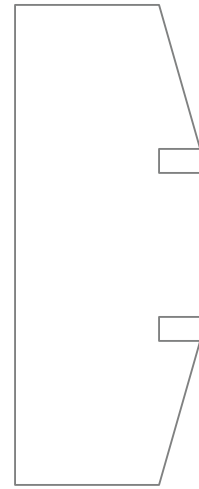

PM-3141

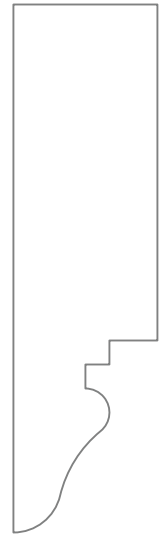

PM-3142

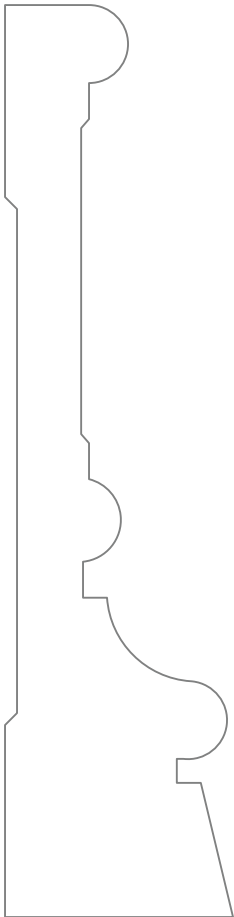

PM-3018

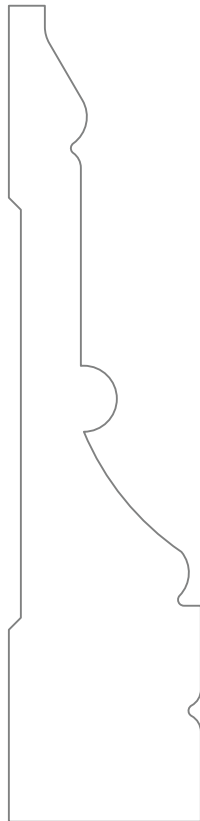

PM-3026

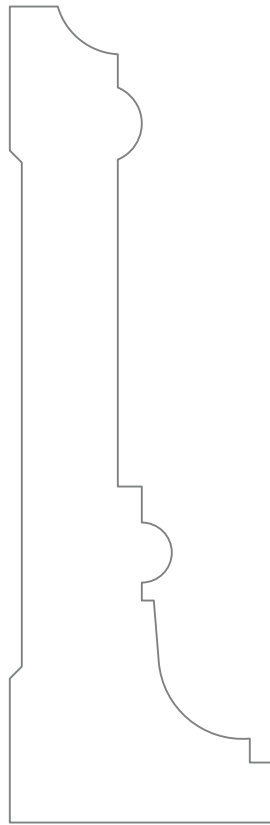

PM-3028



PM-3033

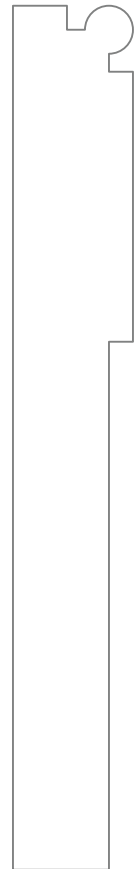

PM-3143



# PIERCE & PIERCE MILLWORK

FULL SCALE

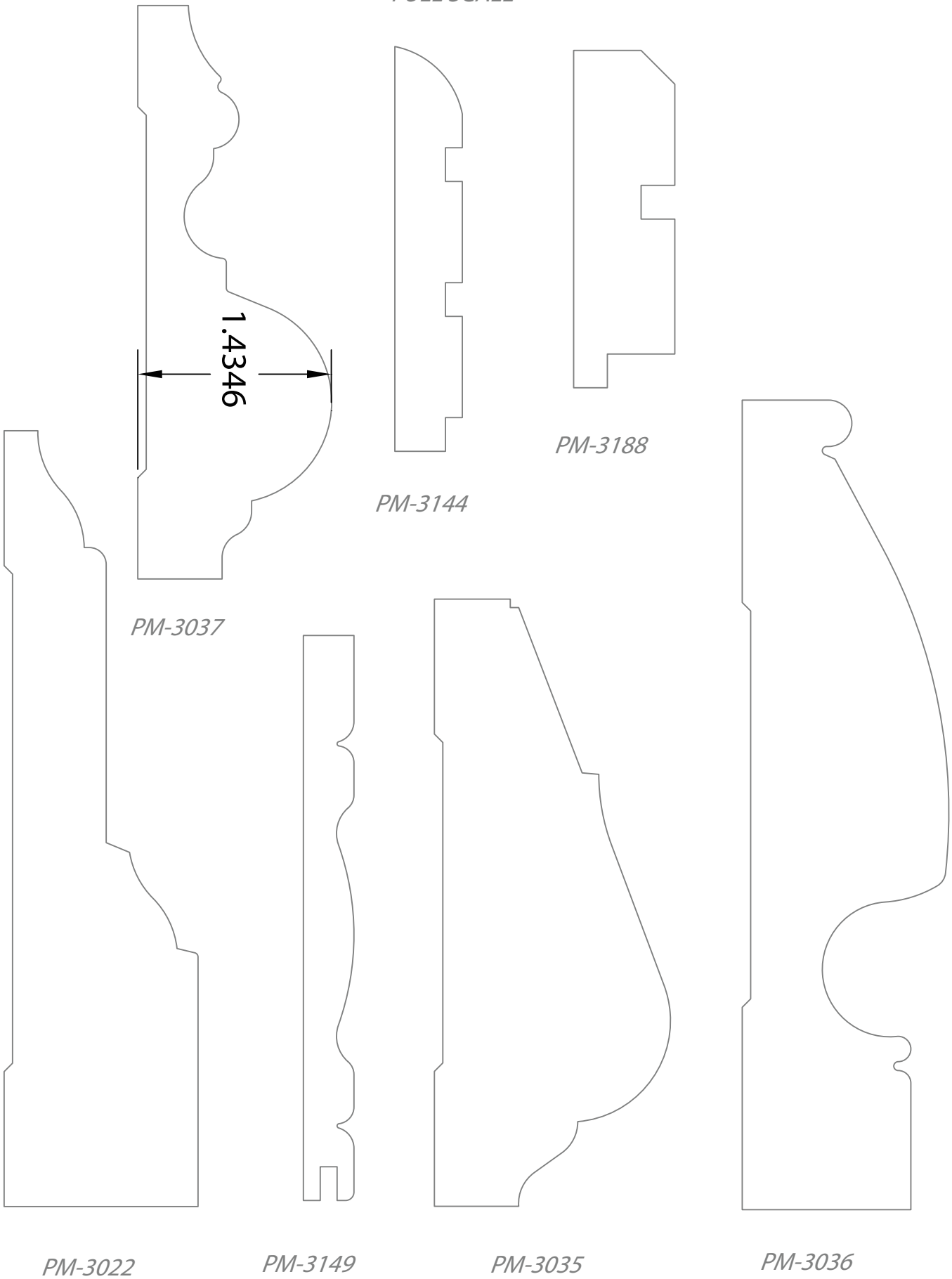

*PIERCE & PIERCE MILLWORK*

*FULL SCALE*

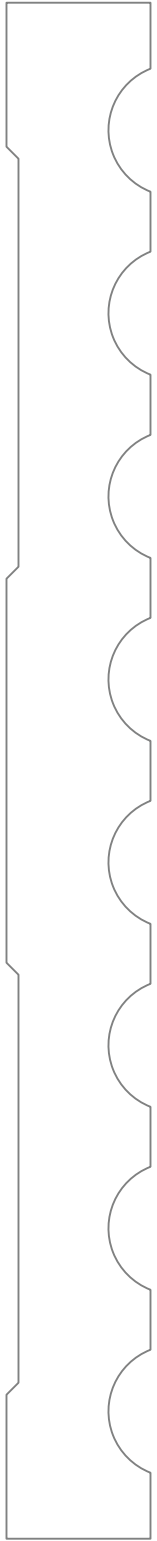

*PM-3038*



*PM-3040*

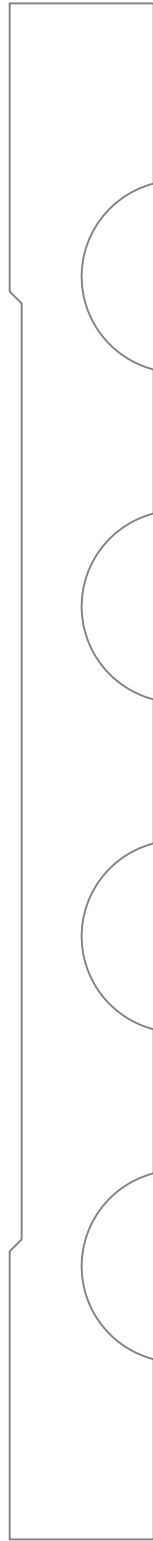

*PM-3043*

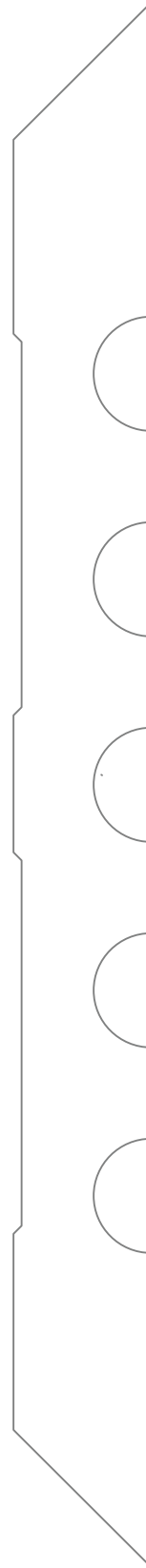

*PM-3153*

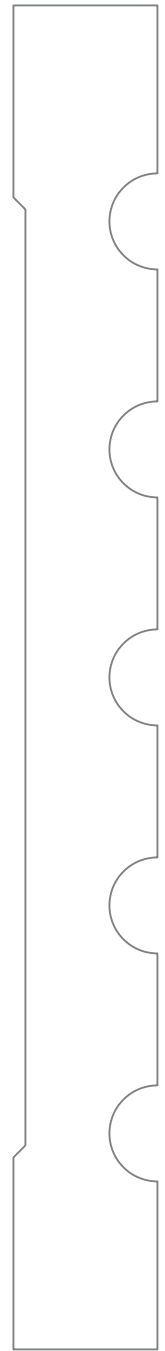

*PM-3047*

*PIERCE & PIERCE MILLWORK*

*FULL SCALE*

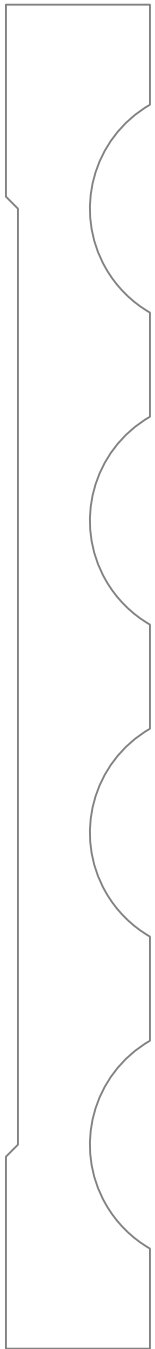

*PM-3041*

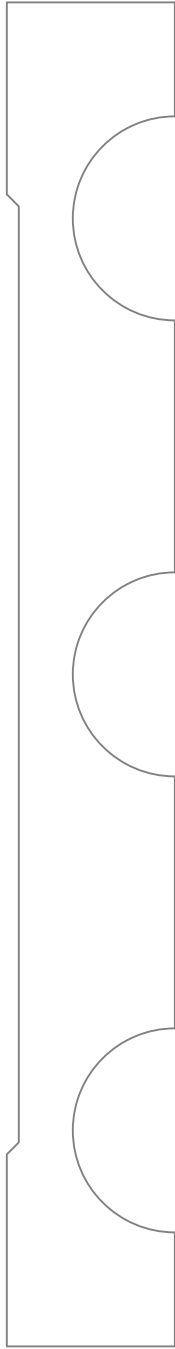

*PM-3042*



*PM-3137*

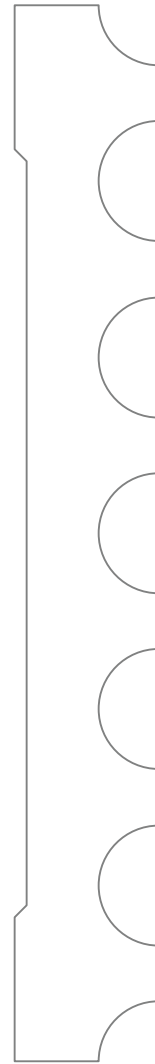

*PM-3209*

*PM-3039*



*PM-3046*



*PM-3200*

*PIERCE & PIERCE MILLWORK*

*FULL SCALE*

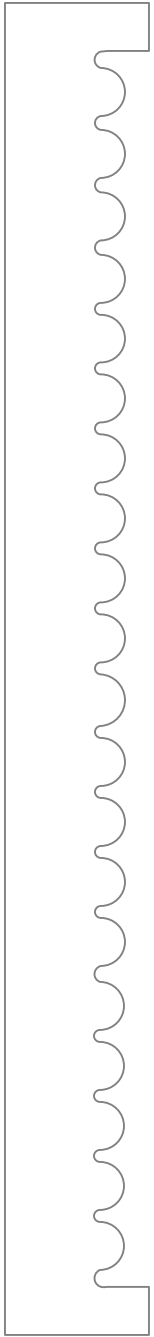

*PM-3138*

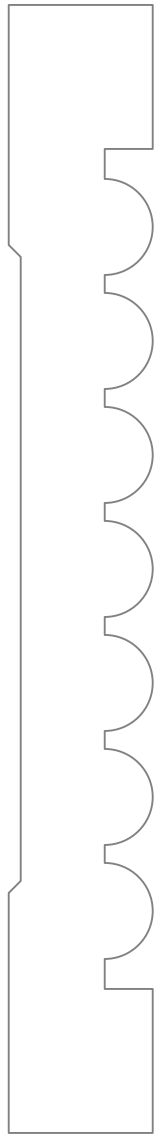

*PM-3159*

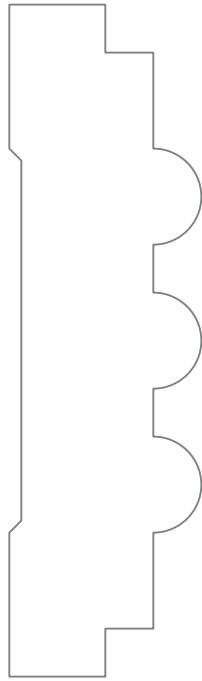

*PM-3139*

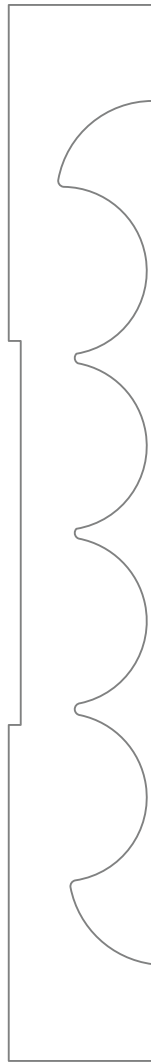

*PM-3048*



*PM-3170*

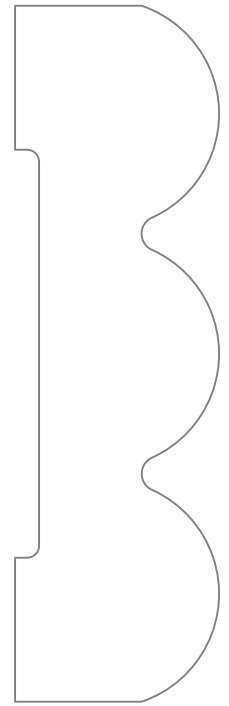

*PM-3218*

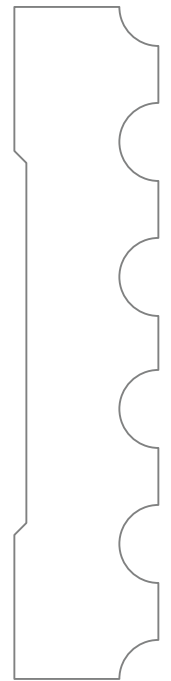

*PM-3236*

*PIERCE & PIERCE MILLWORK*

*FULL SCALE*



*PM-3146*



*PM-3147*



*PM-3195*

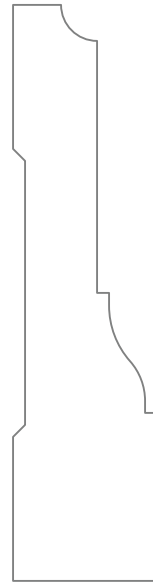

*PM-3164*

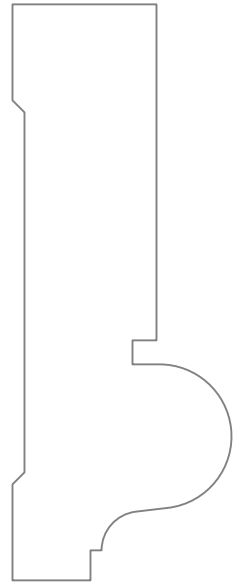

*PM-3165*

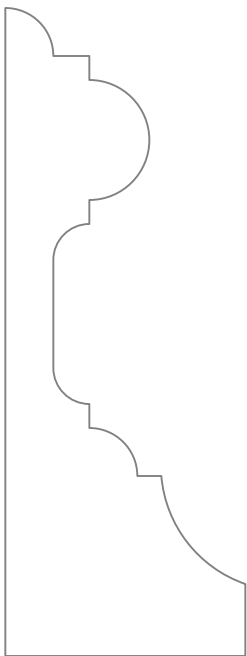

*PM-3151*

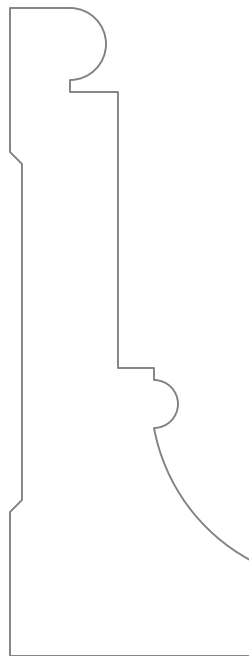

*PM-3140*

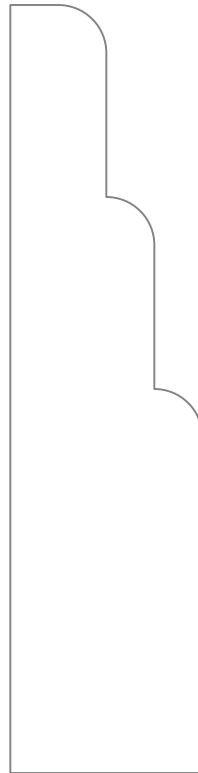

*PM-3145*

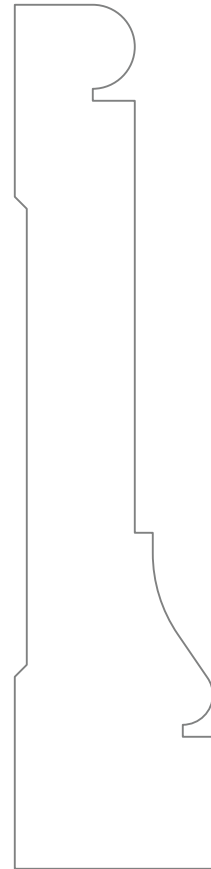

*PM-3148*

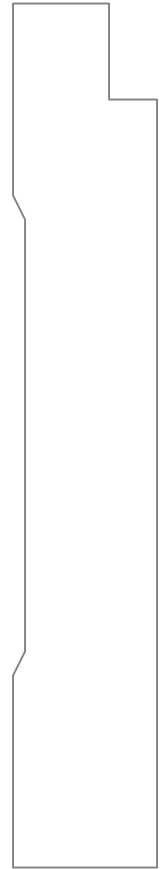

*PM-3156*

*PIERCE & PIERCE MILLWORK*

*FULL SCALE*

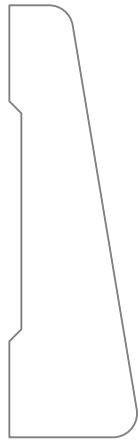

*PM-3150*



*PM-3155*

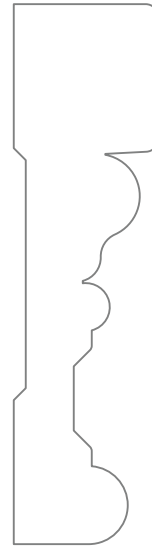

*PM-3186*

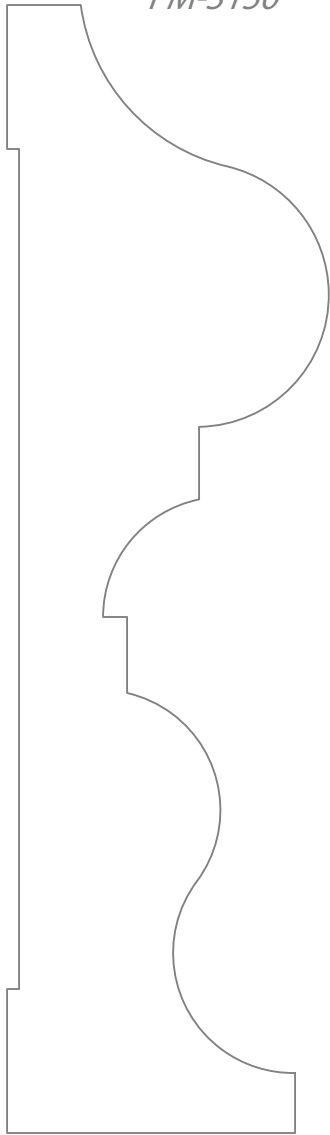

*PM-3133*

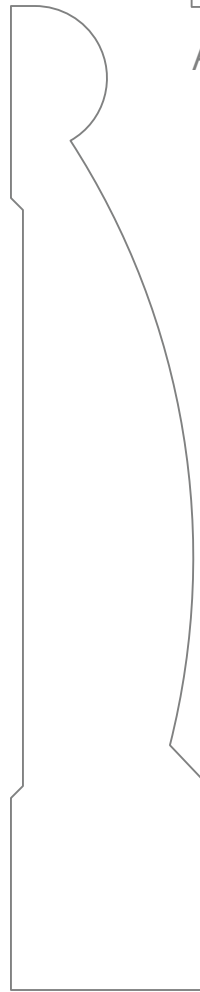

*PM-3154*

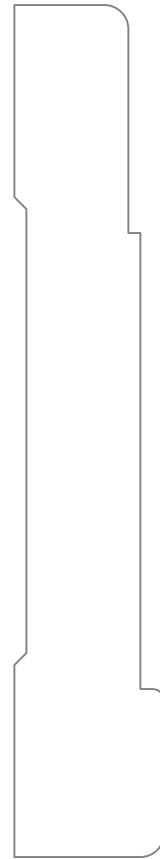

*PM-3160*



*PM-3190*

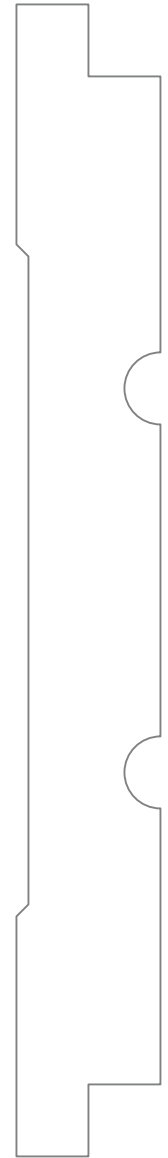

*PM-3157*

*PIERCE & PIERCE MILLWORK*

*FULL SCALE*



*PM-3162*



*PM-3166*



*PM-3231*



*PM-3240*

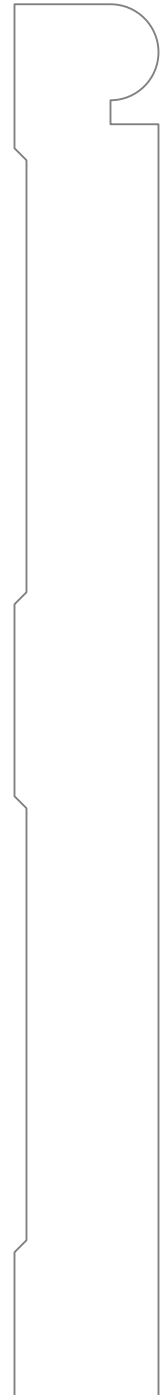

*PM-3185*

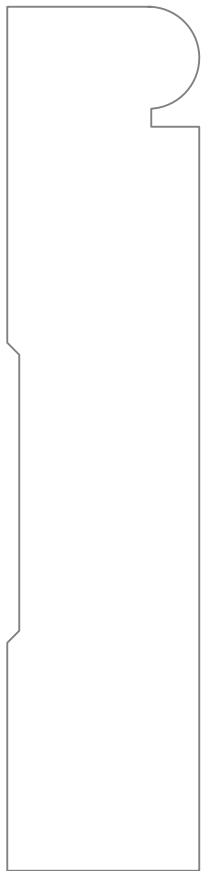

*PM-3219*



*PM-3167*



*PM-3184*

*PIERCE & PIERCE MILLWORK*

*FULL SCALE*

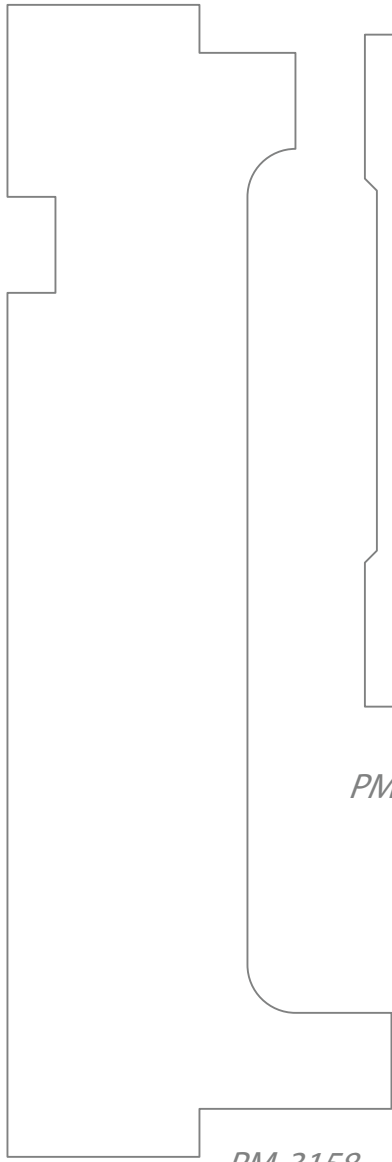

*PM-3158*



*PM-3171*

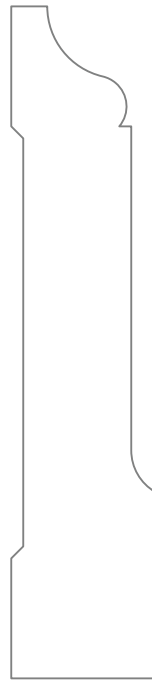

*PM-3187*

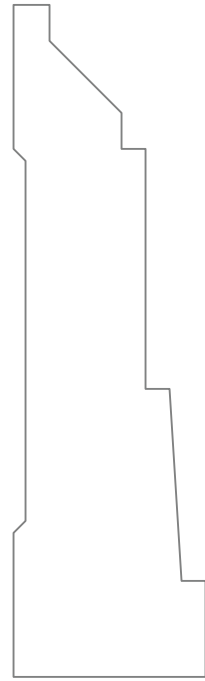

*PM-3215*

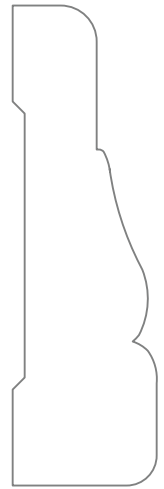

*PM-3220*

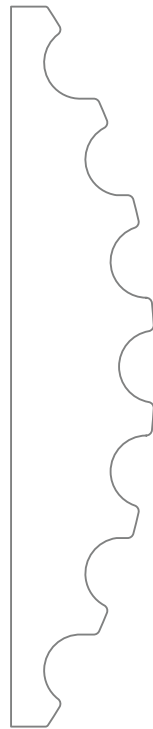

*PM-3183*



*PM-3172*



*PM-3175*

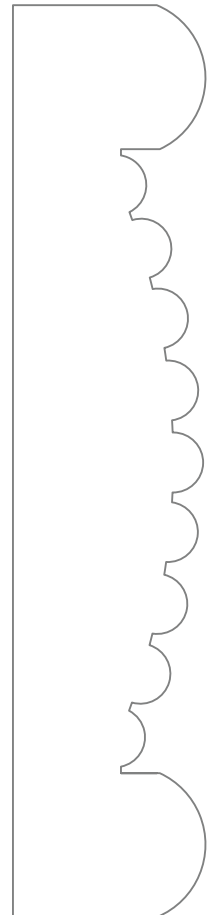

*PM-3131*



*PM-3205*

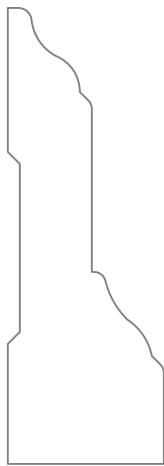

*PM-3238*



*PIERCE & PIERCE MILLWORK*

*FULL SCALE*

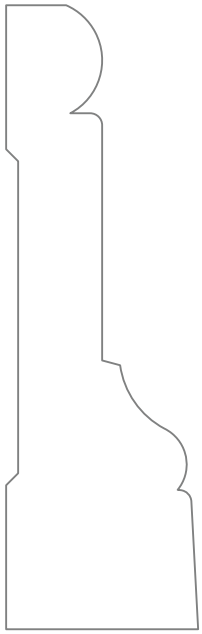

*PM-3235*

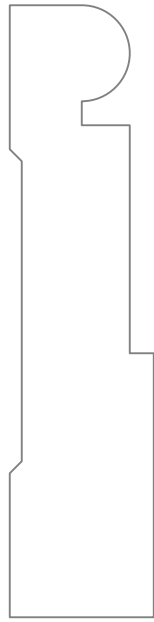

*PM-3210*



*PM-3223*

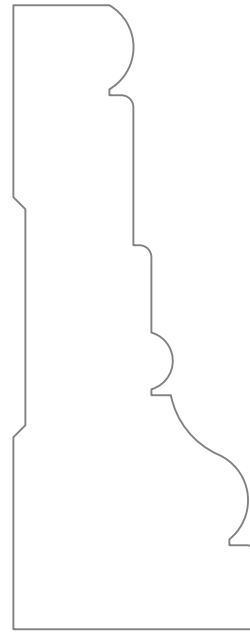

*PM-3242*

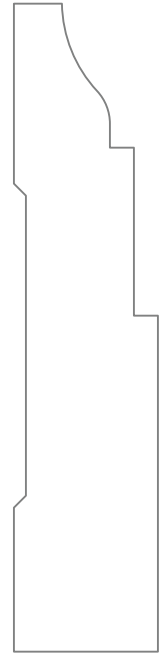

*PM-3230*

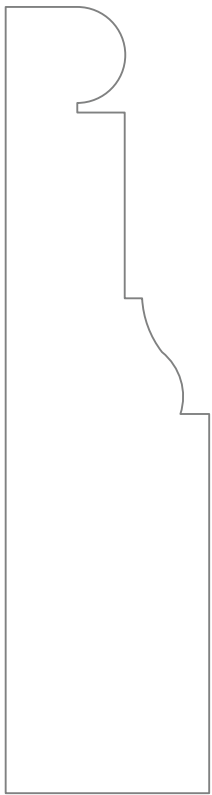

*PM-3173*



*PM-3237*

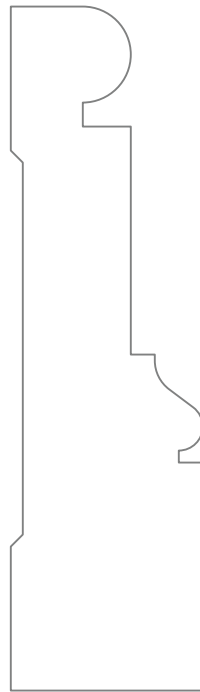

*PM-3211*

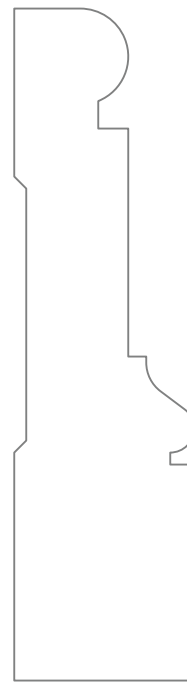

*PM-3247*

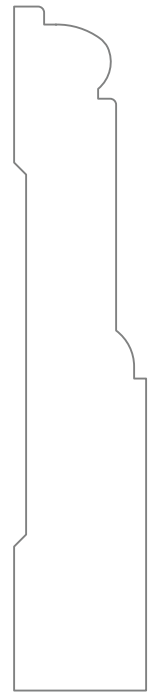

*PM-3239*

*PIERCE & PIERCE MILLWORK*

*FULL SCALE*

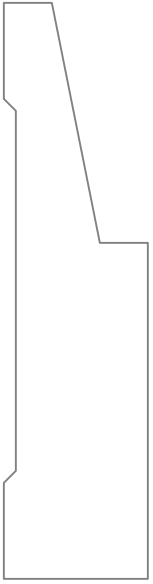

*PM-3201*



*PM-3227*

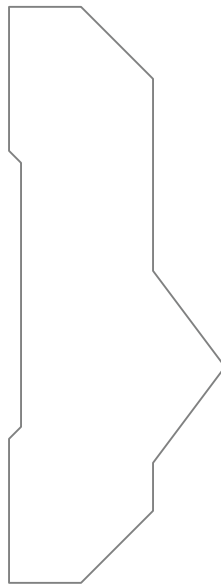

*PM-3225*

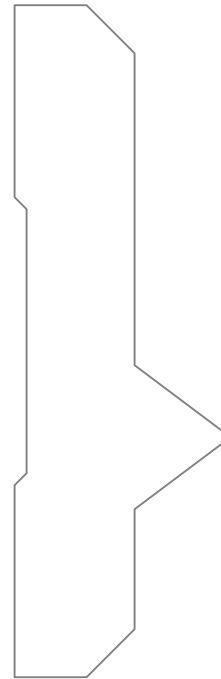

*PM-3226*

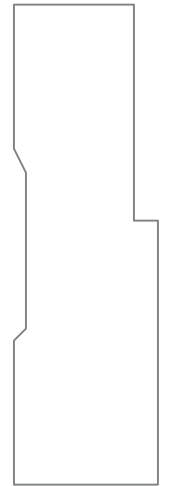

*PM-3233*

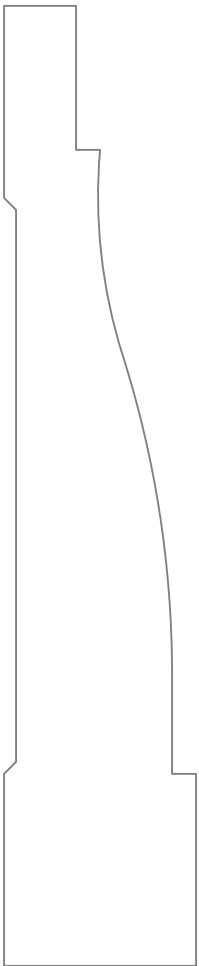

*PM-3174*

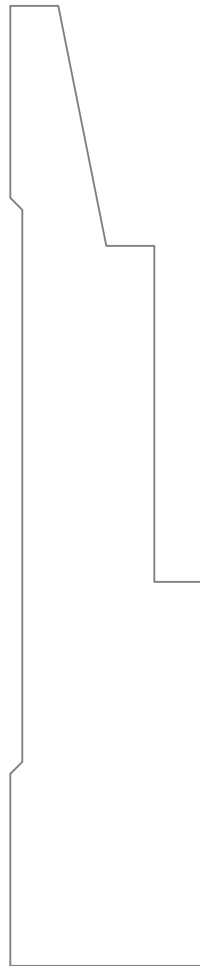

*PM-3202*



*PM-3212*

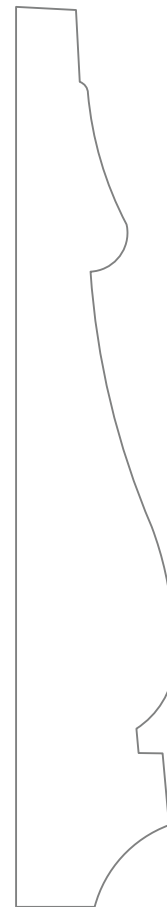

*PM-3176*

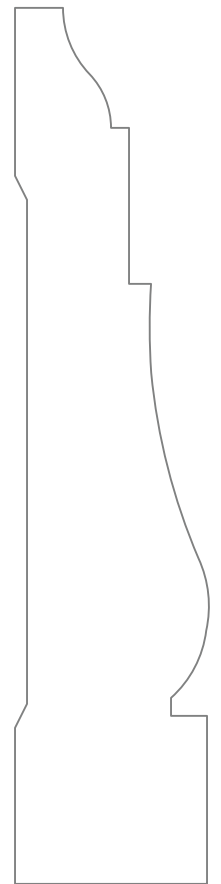

*PM-3191*

*PIERCE & PIERCE MILLWORK*

*FULL SCALE*

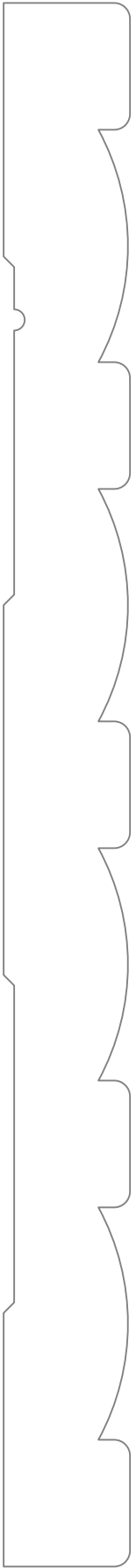

*PM-3207*

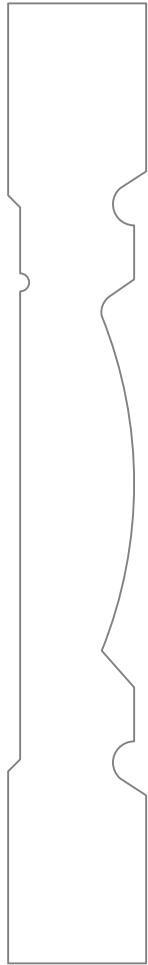

*PM-3248*

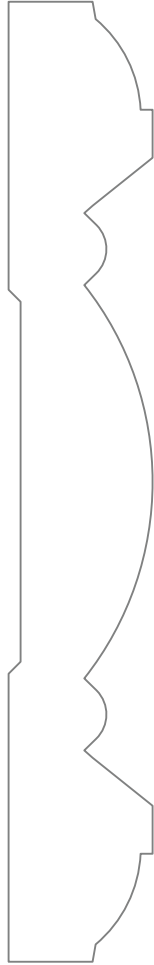

*PM-3189*

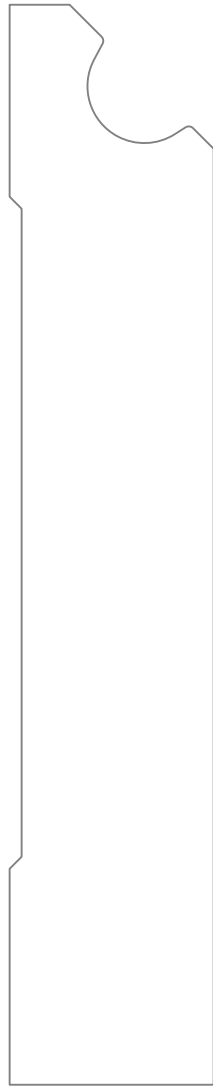

*PM-3199*



*PM-3228*

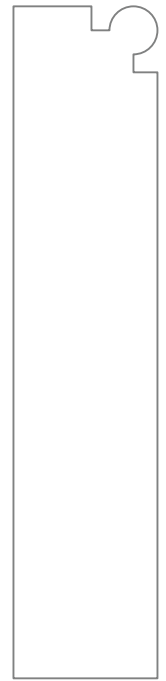

*PM-3163*

# PIERCE & PIERCE MILLWORK

FULL SCALE

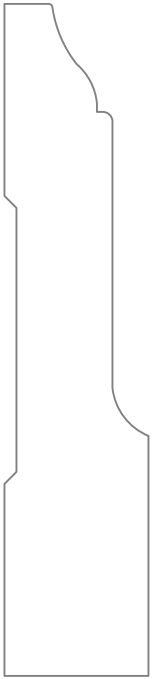

PM-3241



PM-3208

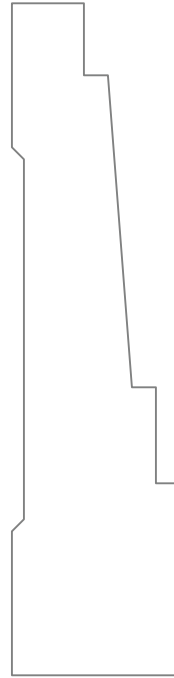

PM-3213

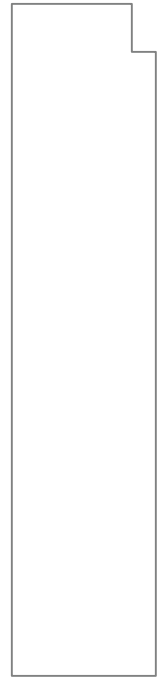

PM-3217

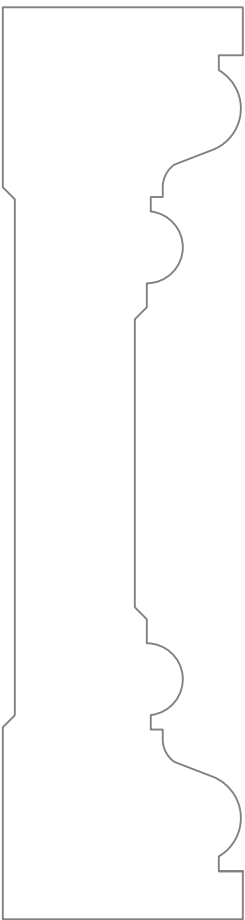

PM-3193

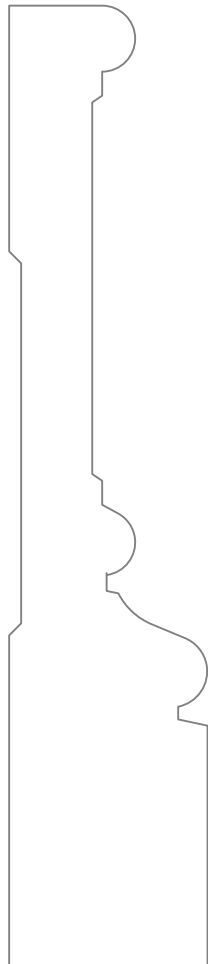

PM-3229

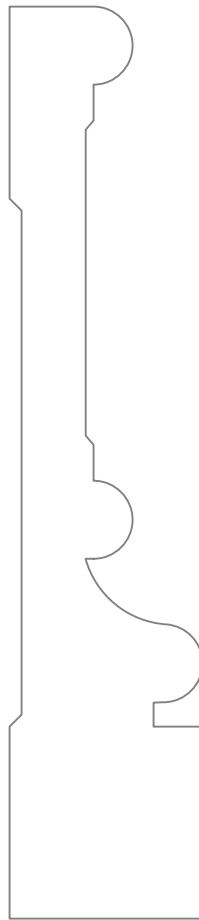

PM-3243



PM-3246

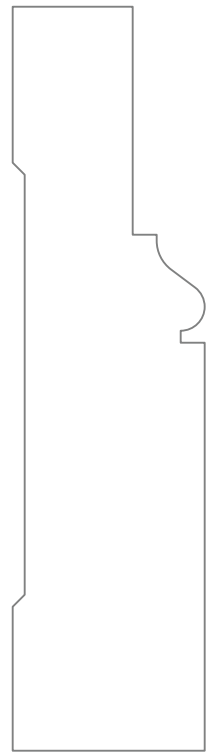

PM-3234

*PIERCE & PIERCE MILLWORK*

*FULL SCALE*

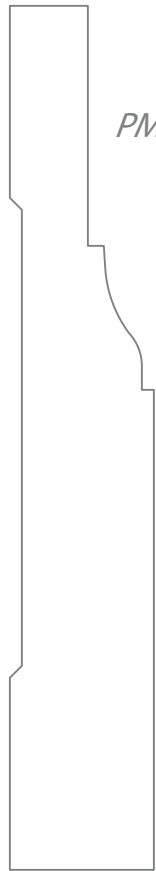

*PM-3232*

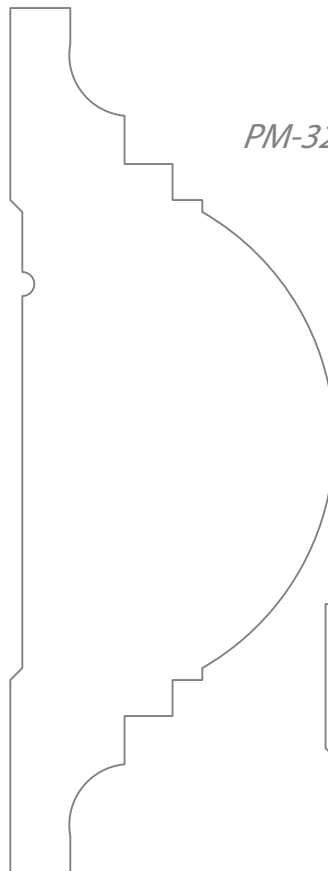

*PM-3244*

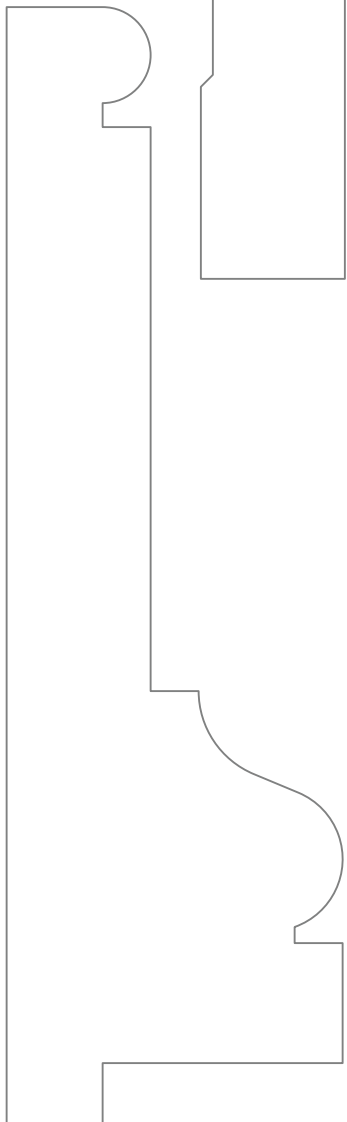

*PM-3224*

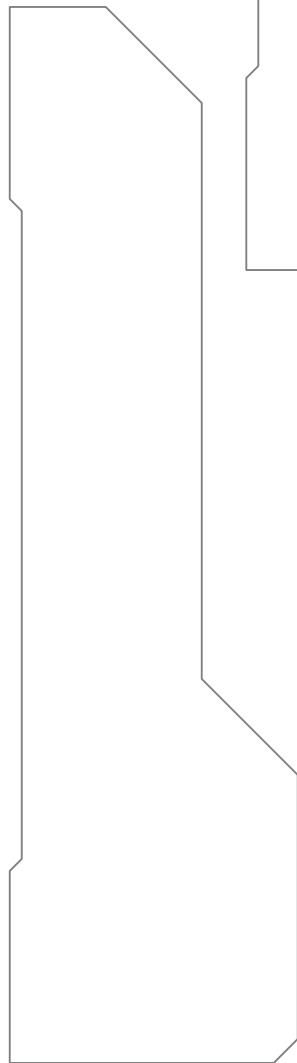

*PM-3245*



*PM-3222*

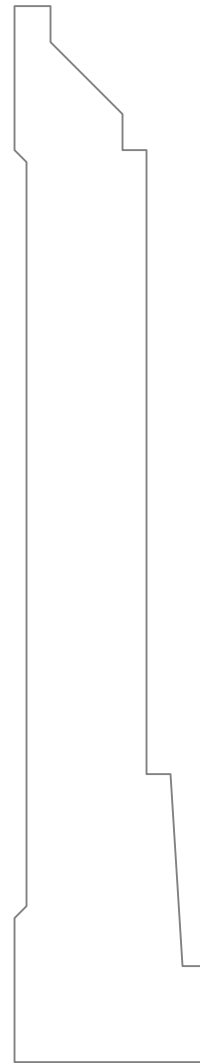

*PM-3216*

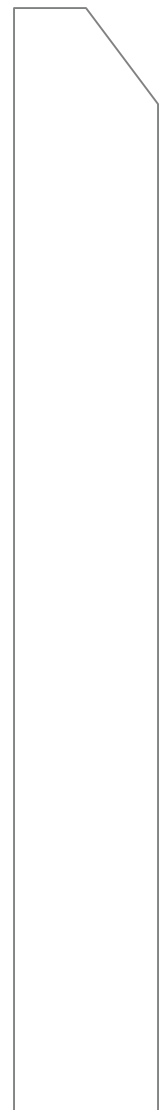

*PM-3249*

# PIERCE & PIERCE MILLWORK

FULL SCALE

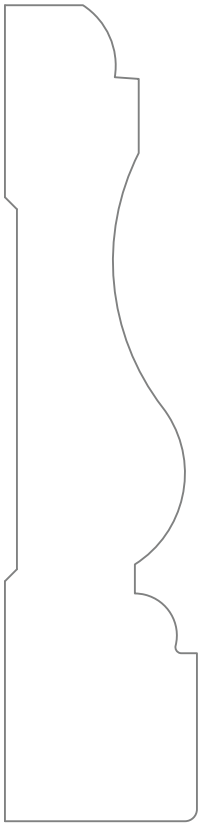

PM-3251



PM-3277

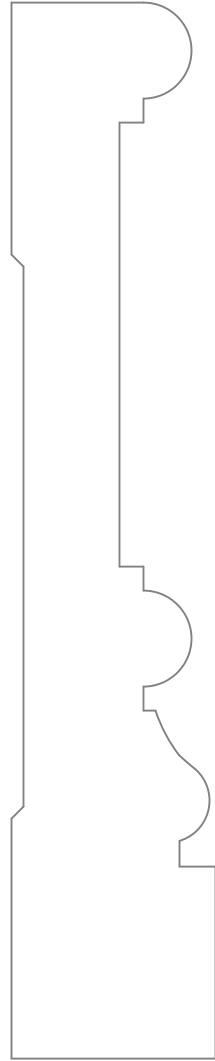

PM-3253

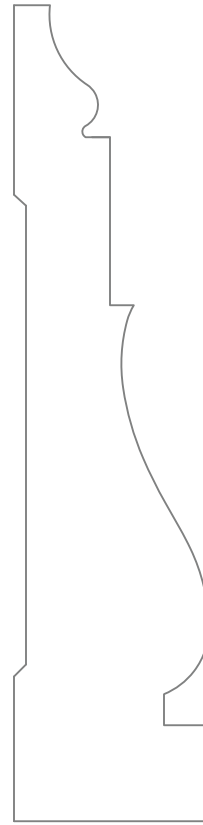

PM-3254

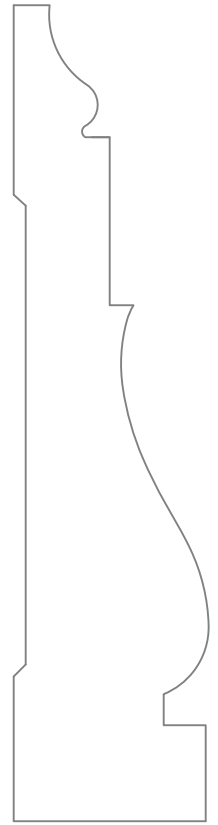

PM-3255

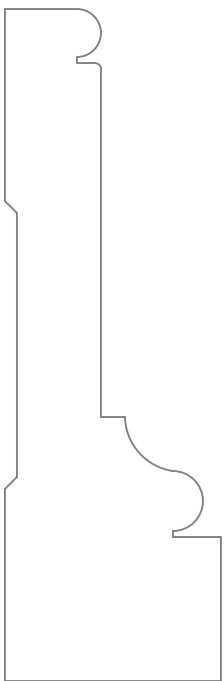

PM-3266

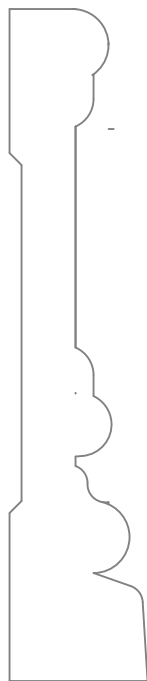

PM-3276

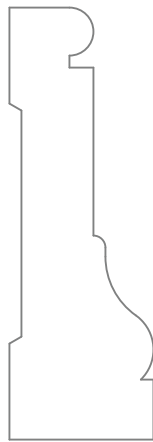

PM-3297



PM-3275

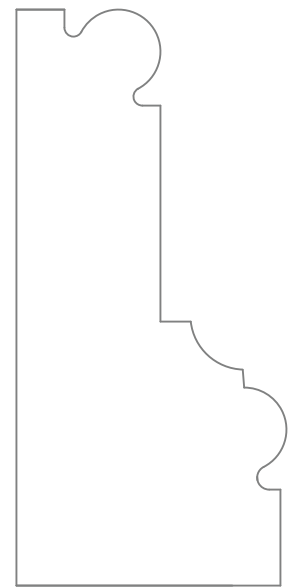

PM-3263

# PIERCE & PIERCE MILLWORK

FULL SCALE



PM-3288

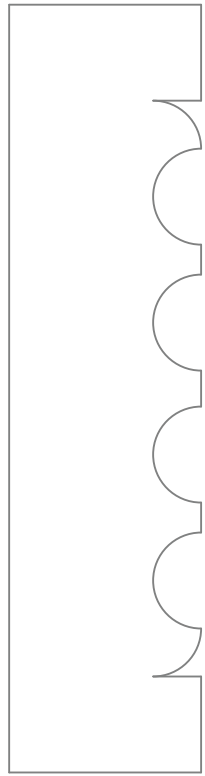

PM-3268



PM-3299

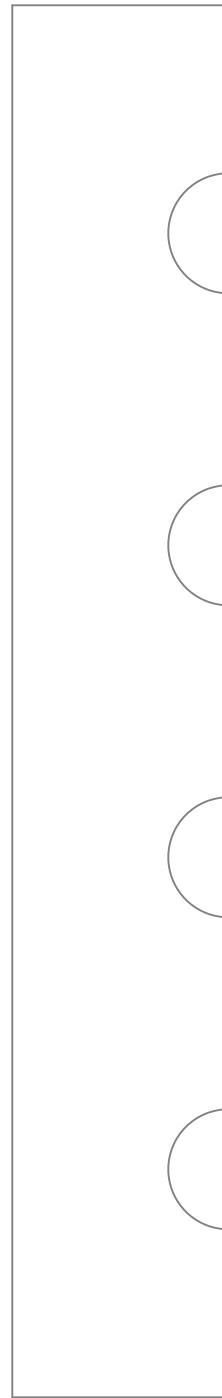

PM-3291

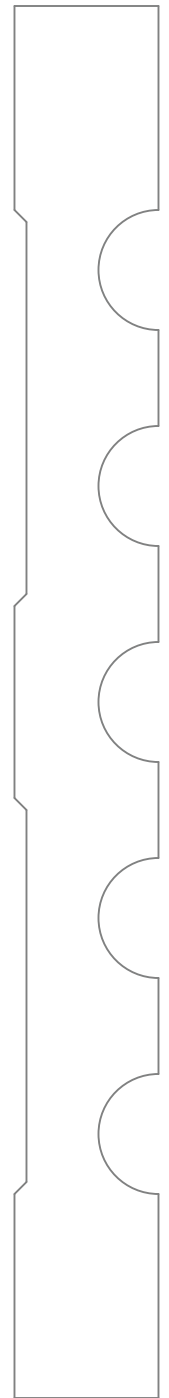

PM-3265

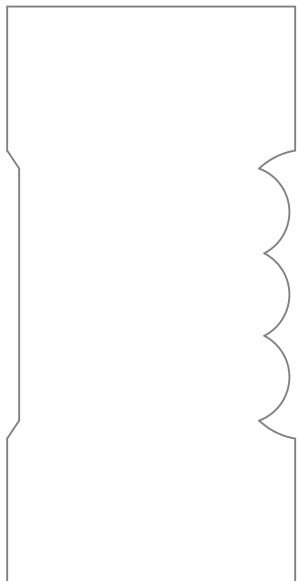

PM-3252

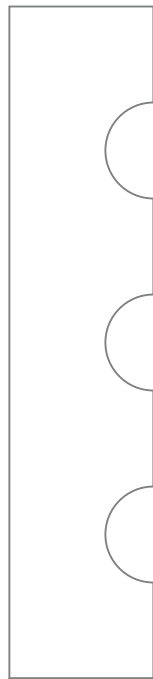

PM-3298



PM-3289

# PIERCE & PIERCE MILLWORK

FULL SCALE

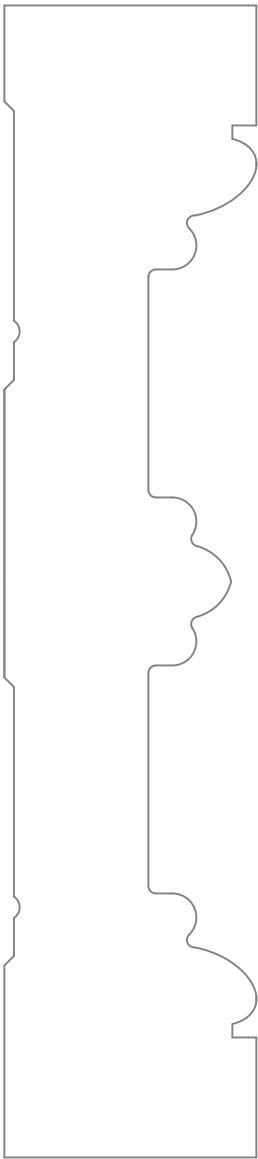

PM-3282

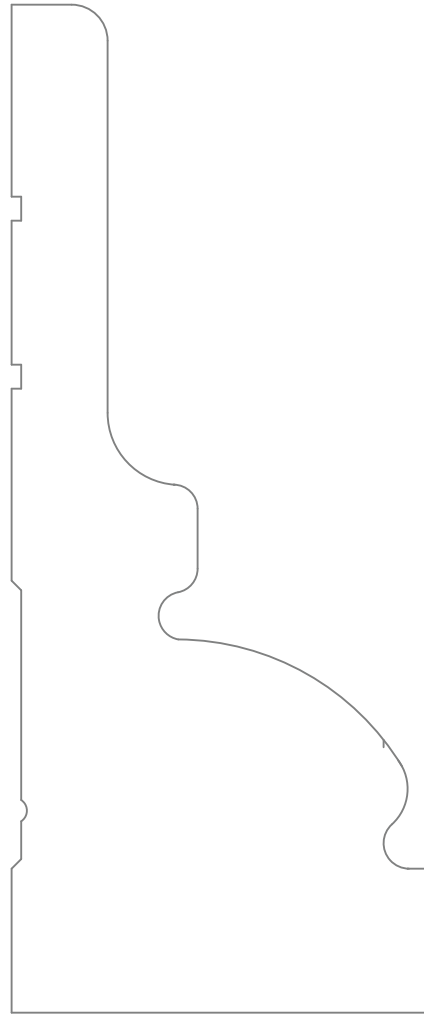

PM-3281

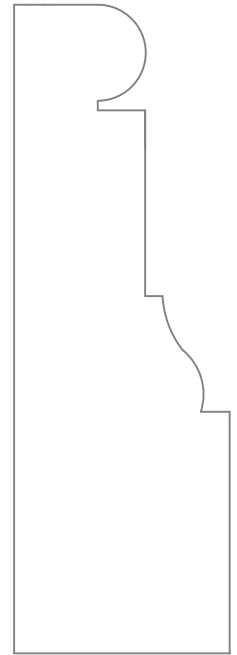

PM-3267

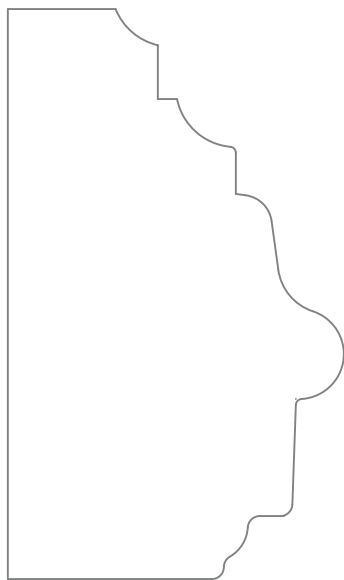

PM-3271

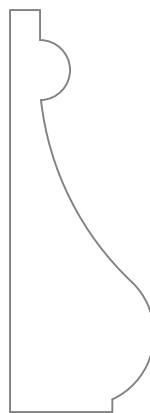

PM-3293



PM-3280



PM-3269

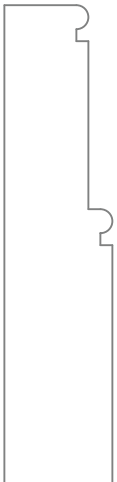

PM-3287



*PIERCE & PIERCE MILLWORK*

*FULL SCALE*

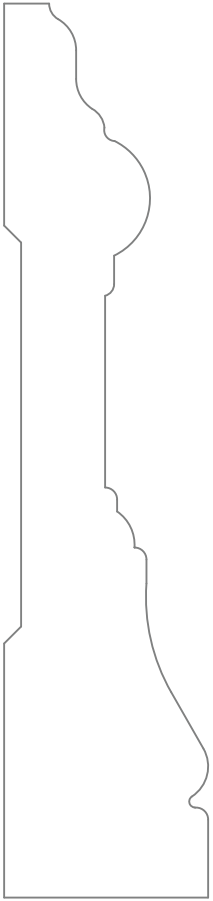

*PM-3256*

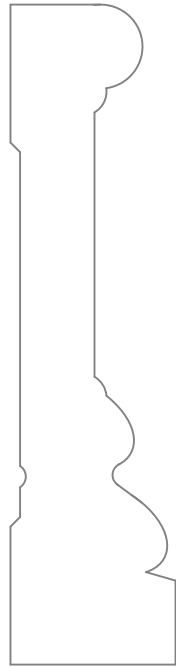

*PM-3292*



*PM-3295*



*PM-3284*

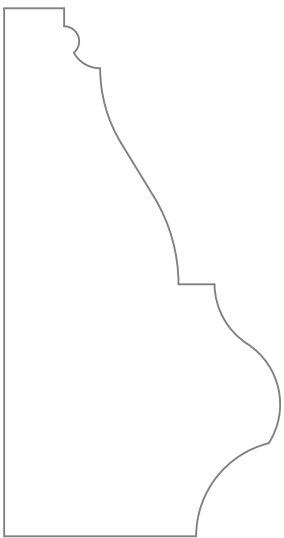

*PM-3290*

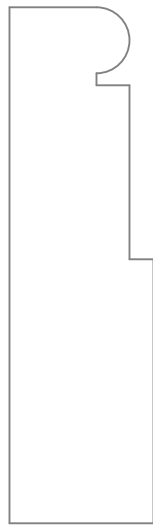

*PM-3278*

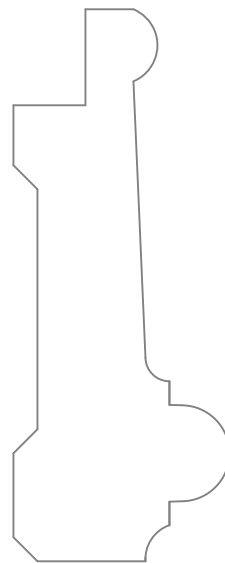

*PM-3294*

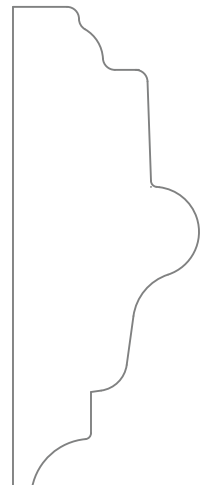

*PM-3283*

*PIERCE & PIERCE MILLWORK*

*FULL SCALE*

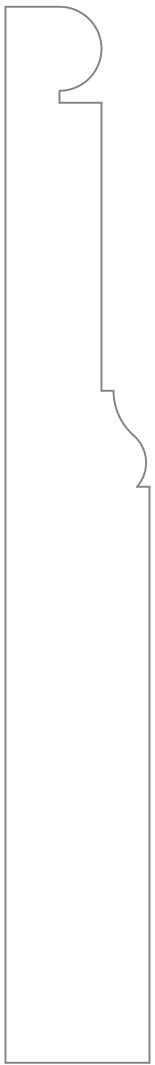

*PM-3313*

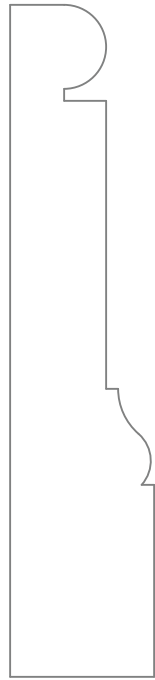

*PM-3312*



*PM-3320*

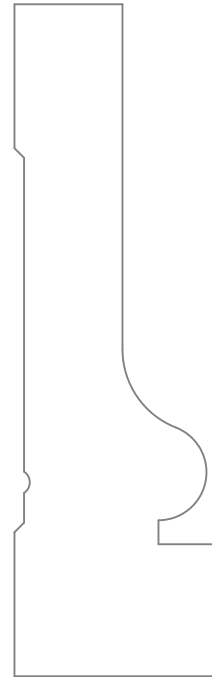

*PM-3327*

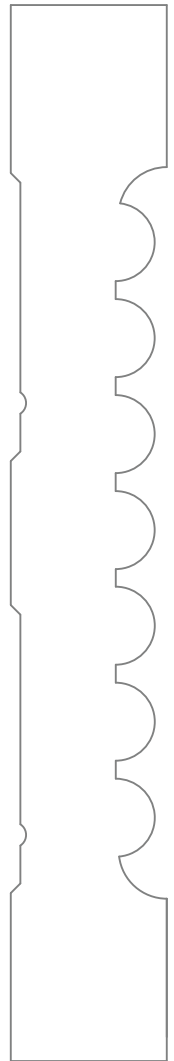

*PM-3311*

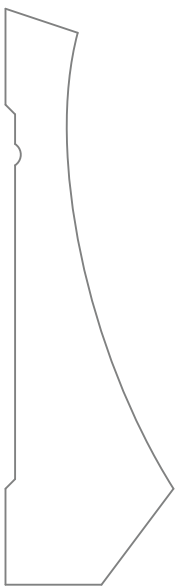

*PM-3324*



*PM-3305*



*PM-3307*

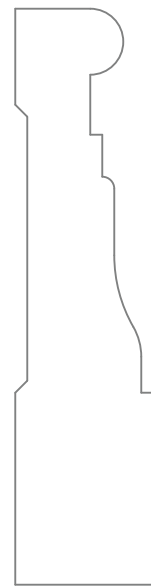

*PM-3331*

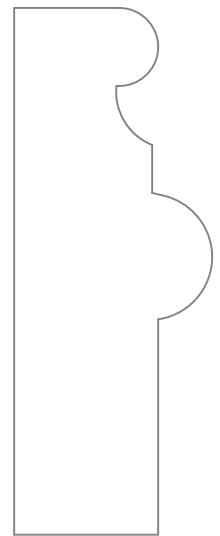

*PM-3300*

*PIERCE & PIERCE MILLWORK*

*FULL SCALE*

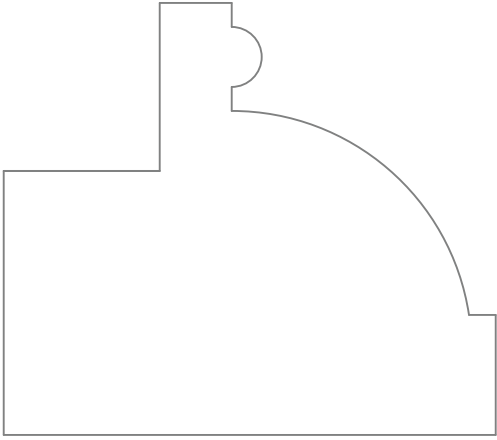

*PM-3316*

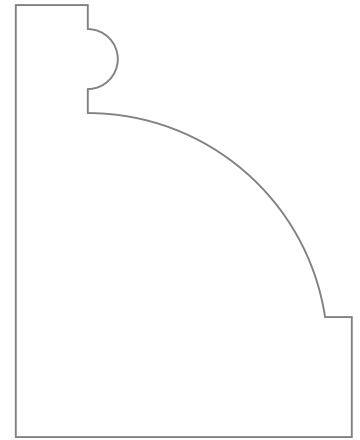

*PM-3310*

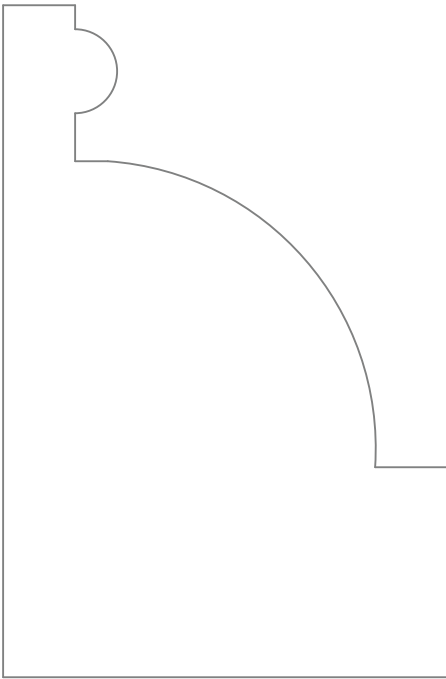

*PM-3319*

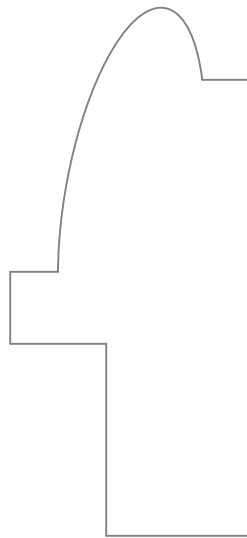

*PM-3328*

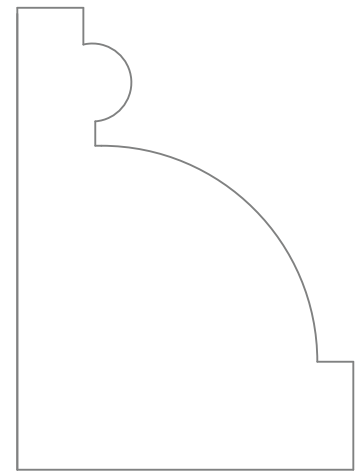

*PM-3314*

*PIERCE & PIERCE MILLWORK*

*FULL SCALE*



*PM-3325*



*PM-3322*

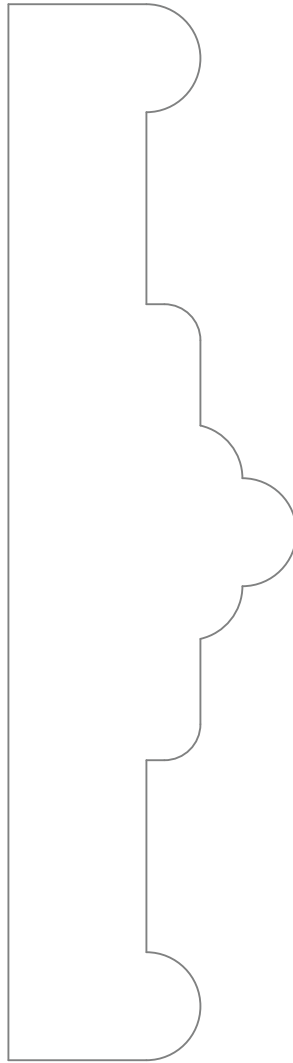

*PM-3330*

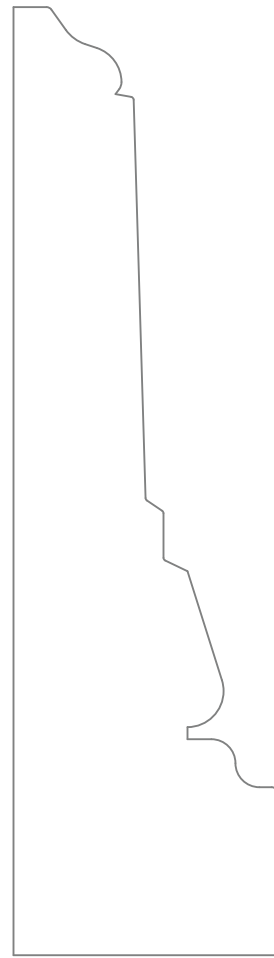

*PM-3323*

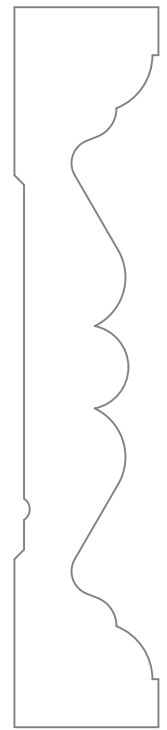

*PM-3329*

# PIERCE & PIERCE MILLWORK

FULL SCALE

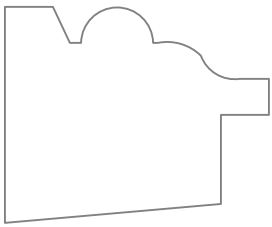

PM-3528

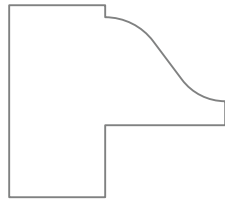

PM-3535

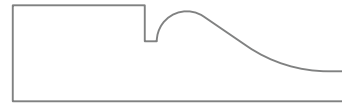

PM-3552



PM-3529

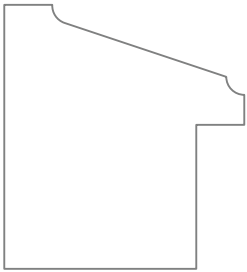

PM-3560

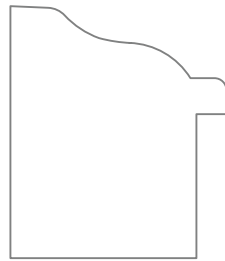

PM-3559

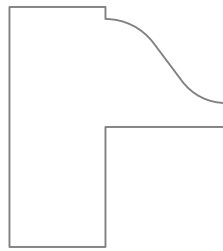

PM-3537



PM-3547

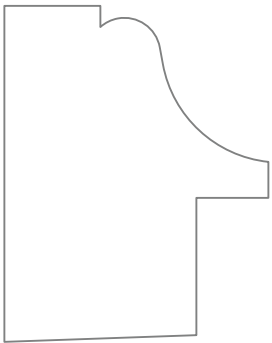

PM-3501

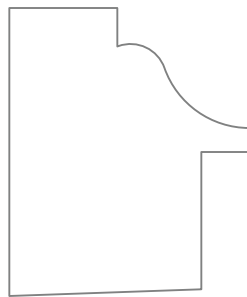

PM-3503

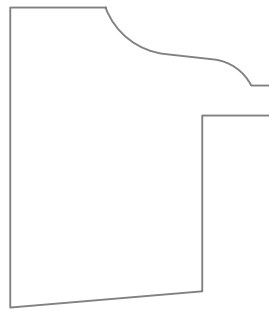

PM-3530

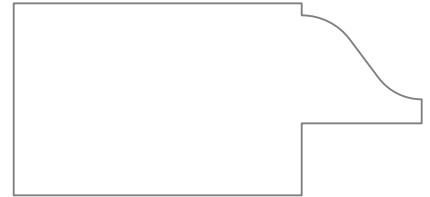

PM-3533

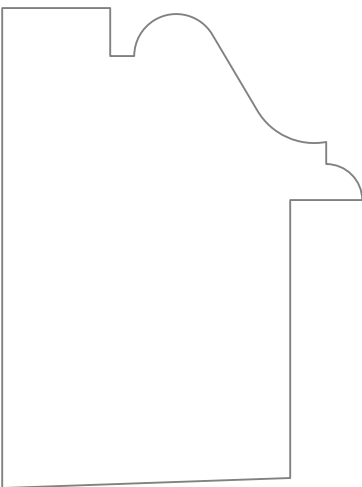

PM-3557

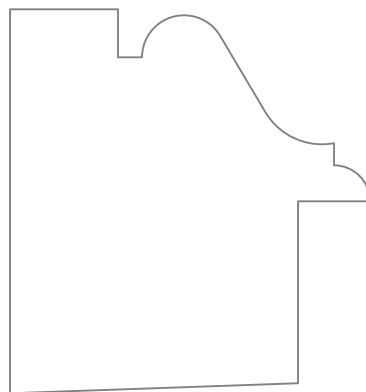

PM-3554

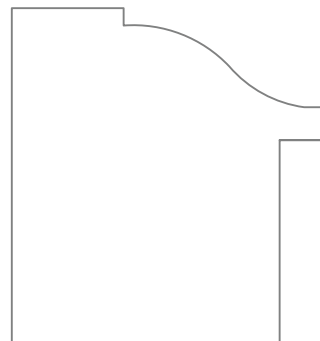

PM-3543

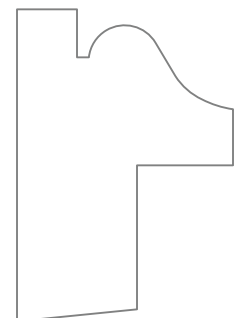

PM-3549

*PIERCE & PIERCE MILLWORK*

*FULL SCALE*



*PM-3538*



*PM-3532*

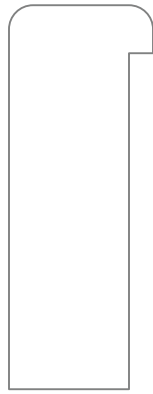

*PM-3542*



*PM-3534*

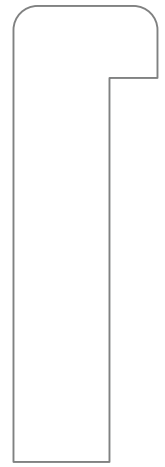

*PM-3536*

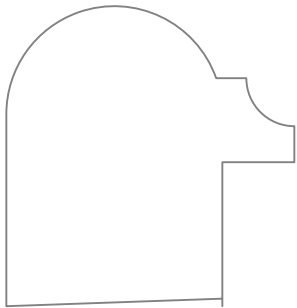

*PM-3504*

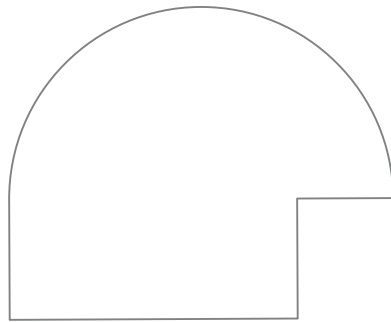

*PM-3527*

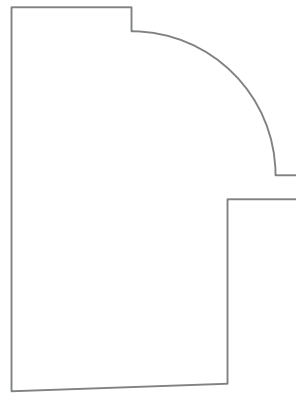

*PM-3539*

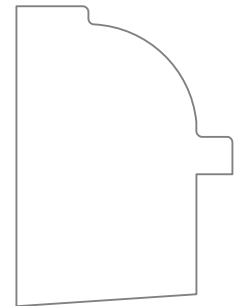

*PM-3558*

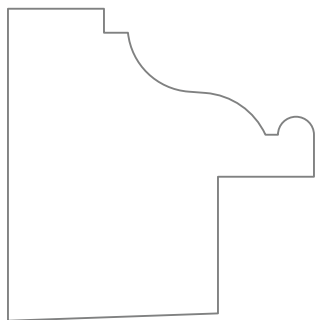

*PM-3553*

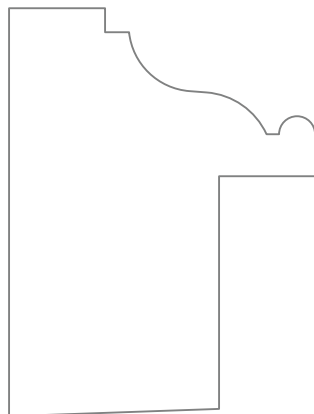

*PM-3556*

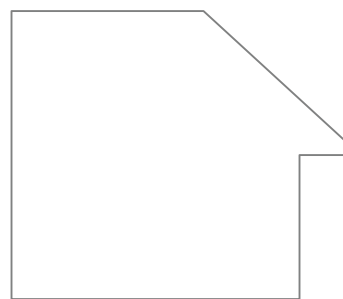

*PM-3561*

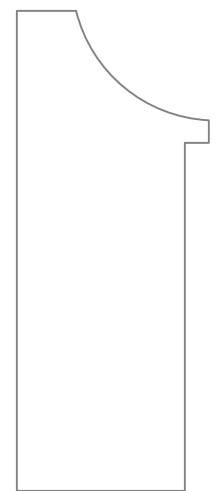

*PM-3531*

# PIERCE & PIERCE MILLWORK

FULL SCALE

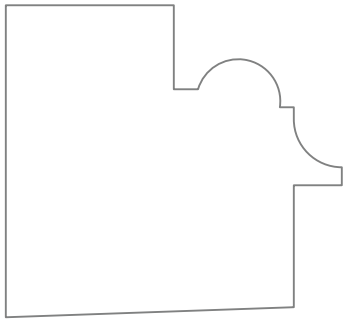

PM-3507

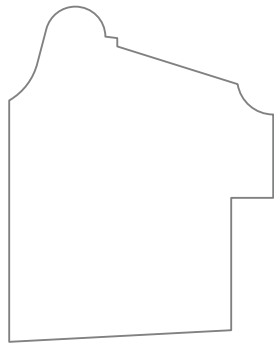

PM-3540

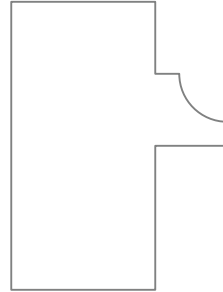

PM-3548

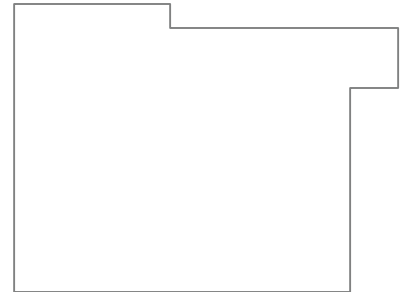

PM-3551

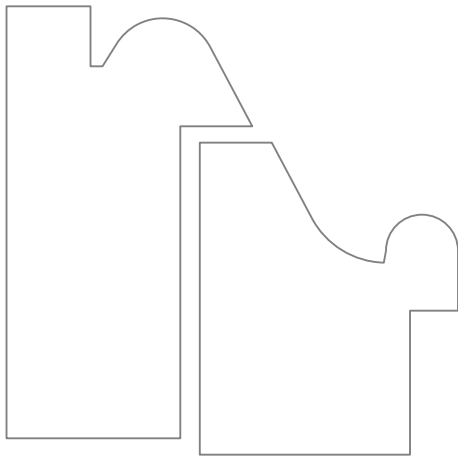

PM-3546

TWO PC. RADIUS

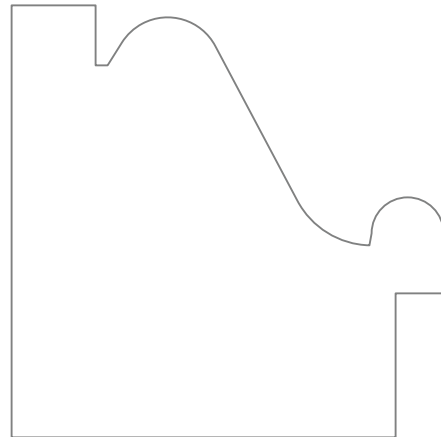

PM-3546

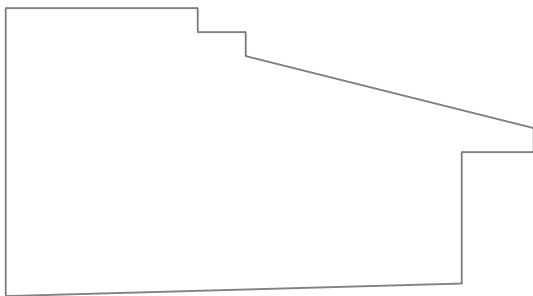

PM-3550

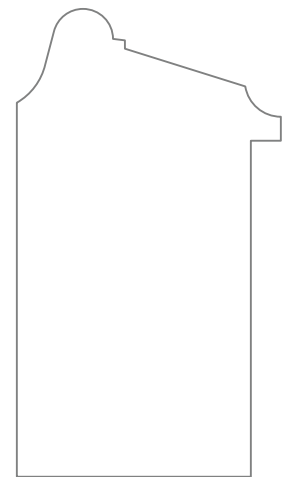

PM-3555

# PIERCE & PIERCE MILLWORK

FULL SCALE

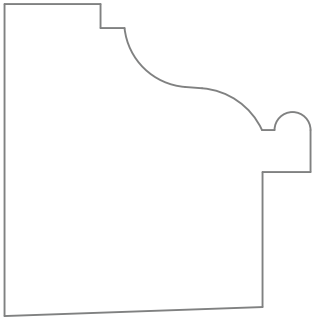

PM-3562

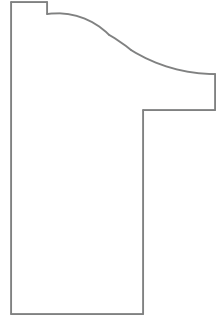

PM-3563

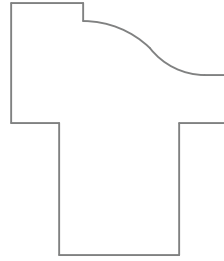

PM-3570

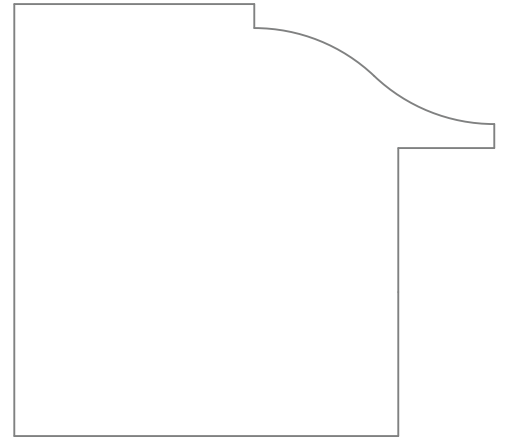

PM-3564

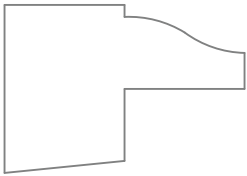

PM-3565

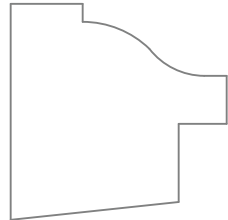

PM-3572

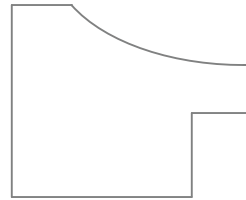

PM-3573

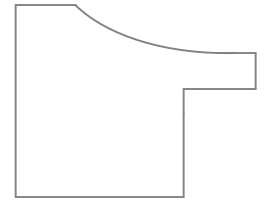

PM-3574

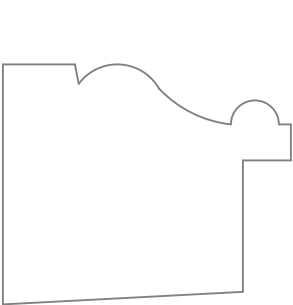

PM-3575

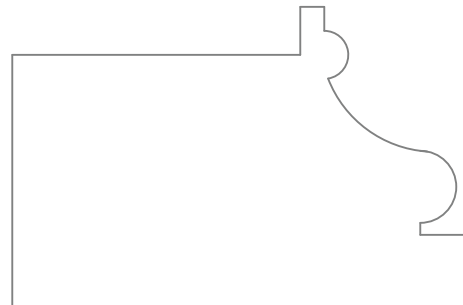

PM-3577



PM-3568

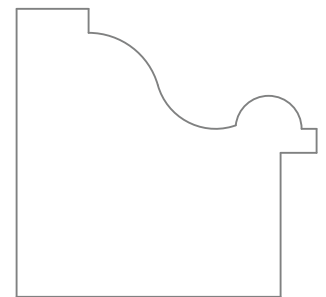

PM-3578



*PIERCE & PIERCE MILLWORK*

*FULL SCALE*

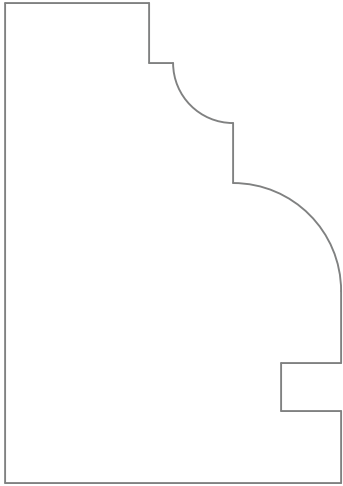

*PM-3581*

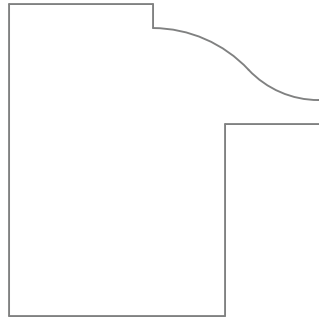

*PM-3583*

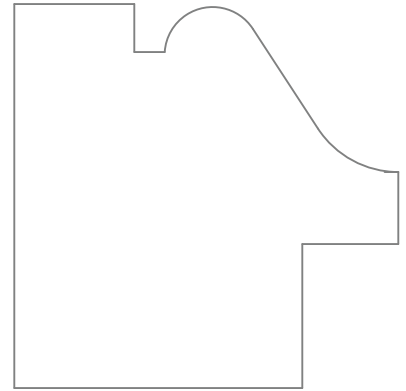

*PM-3589*

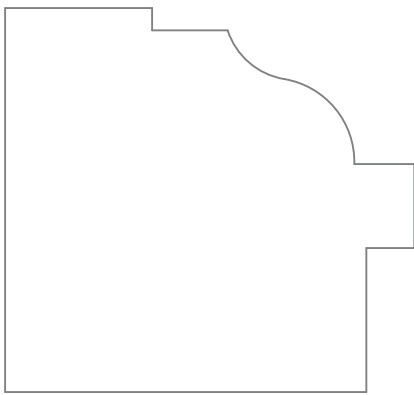

*PM-3584*

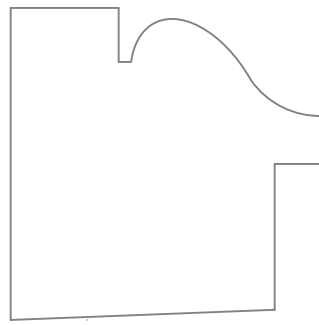

*PM-3586*

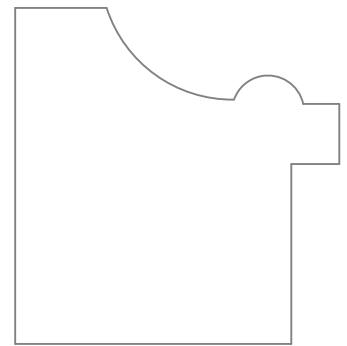

*PM-3597*

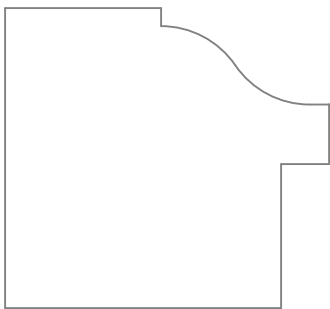

*PM-3590*

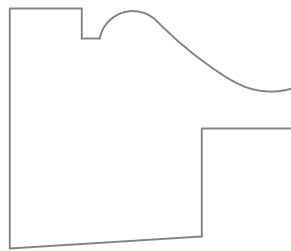

*PM-3579*

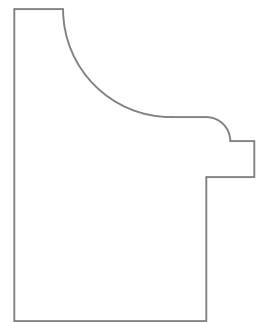

*PM-3593*

*PIERCE & PIERCE MILLWORK*

*FULL SCALE*

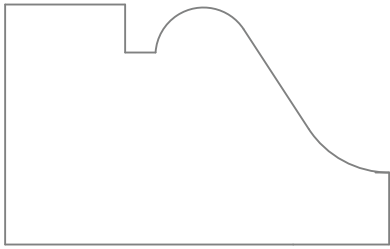

*PM-3592*

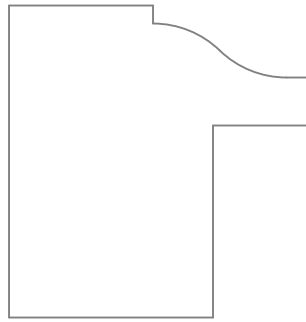

*PM-3596*

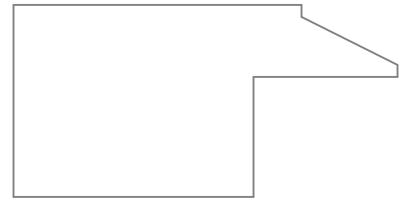

*PM-3598*

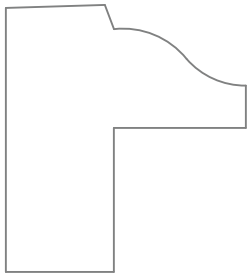

*PM-3587*

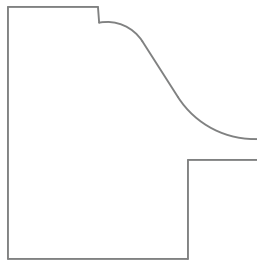

*PM-3588*

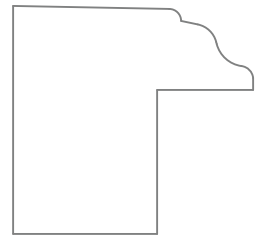

*PM-3594*

# PIERCE & PIERCE MILLWORK

FULL SCALE

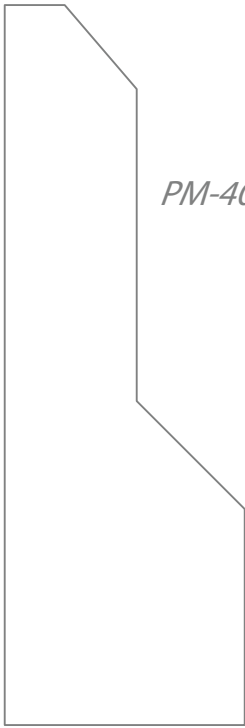

*PM-4033*

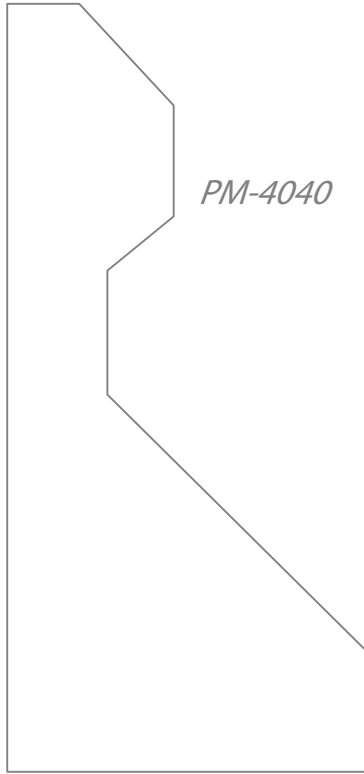

*PM-4040*

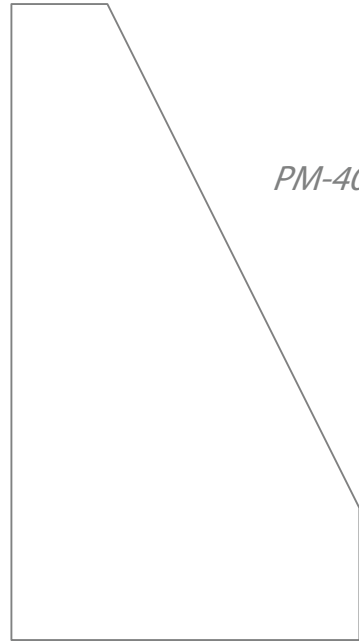

*PM-4049*

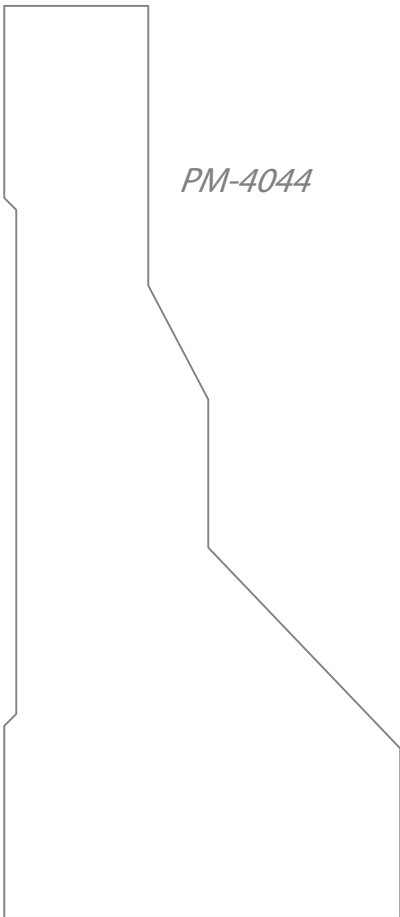

*PM-4044*

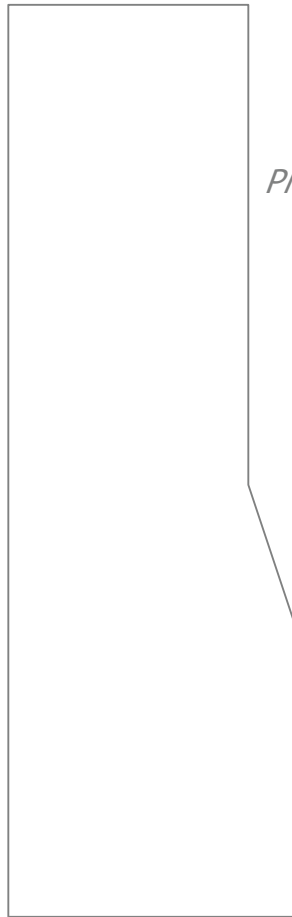

*PM-4046*

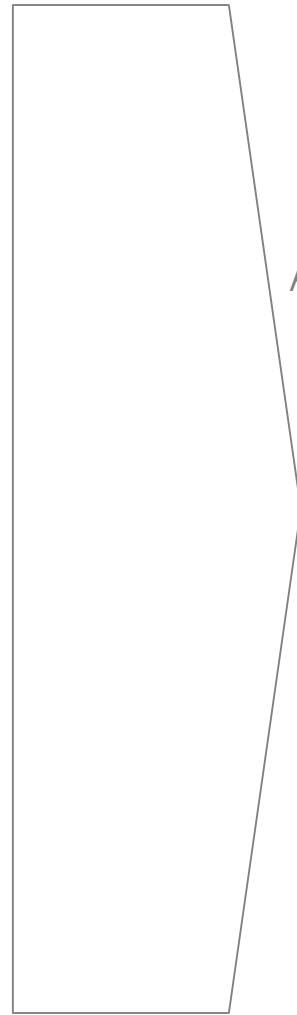

*PM-4051*

*PIERCE & PIERCE MILLWORK*

*FULL SCALE*



*PM-4048*

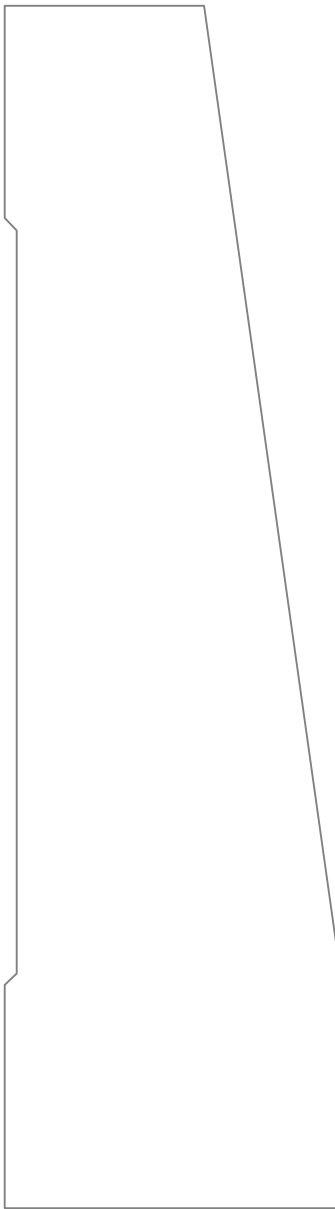

*PM-4035*

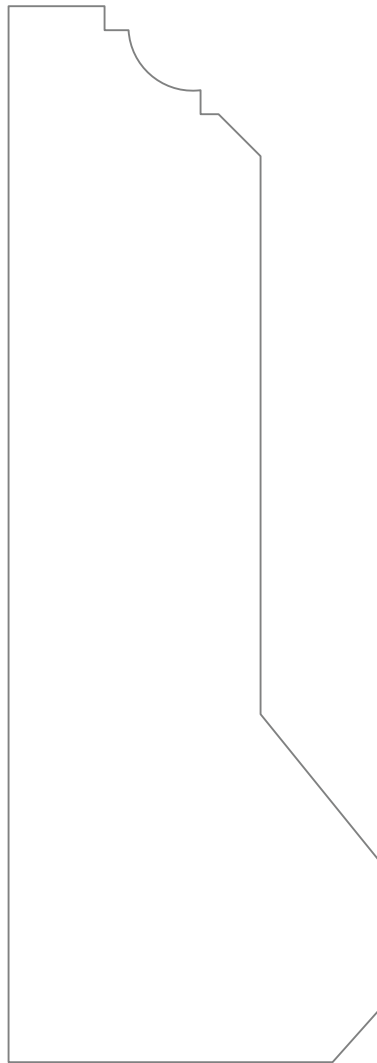

*PM-4034*

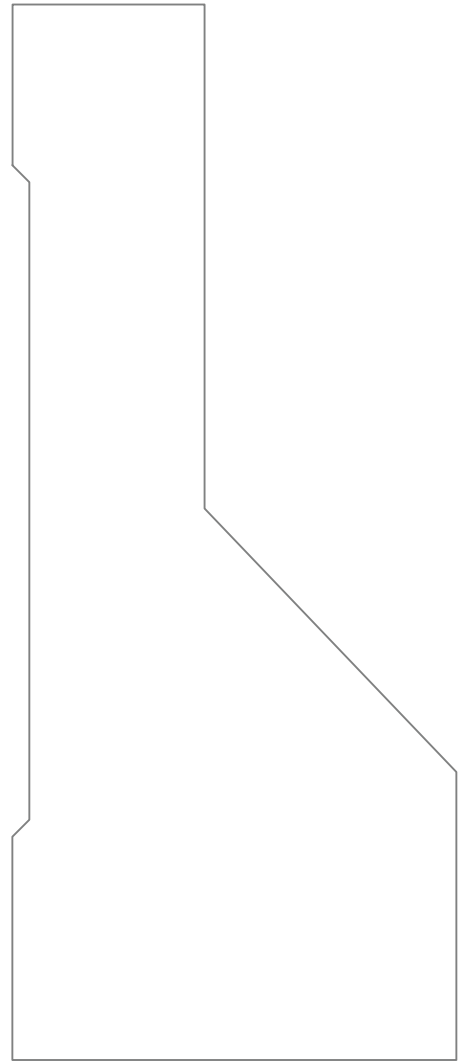

*PM-4036*

*PIERCE & PIERCE MILLWORK*

*FULL SCALE*

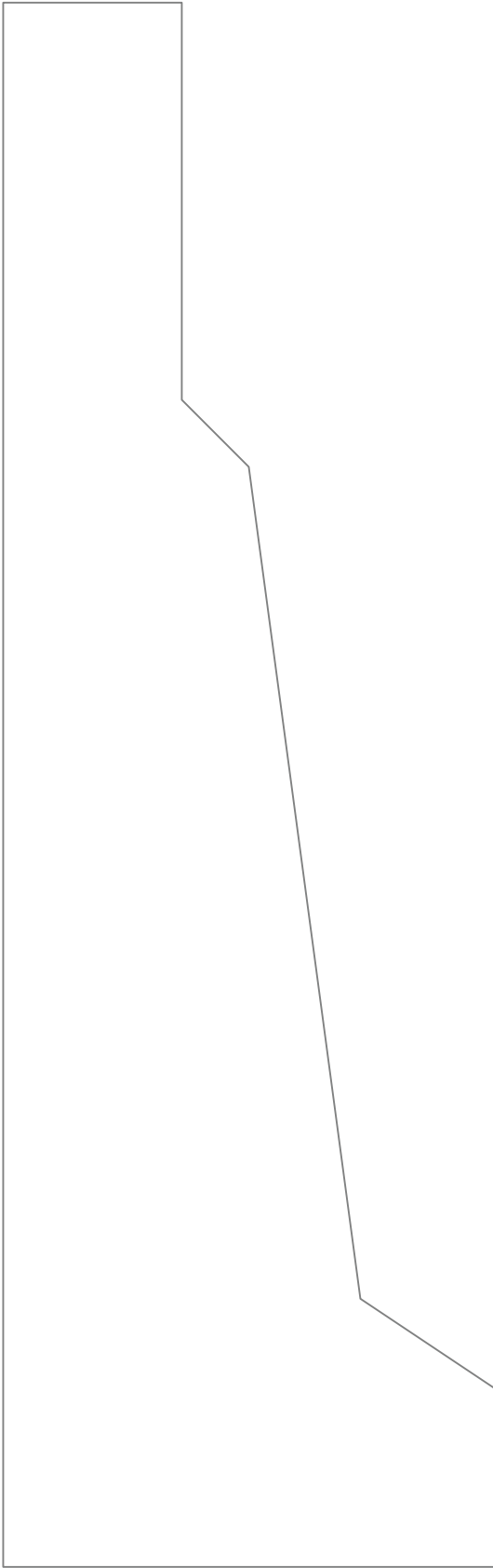

*PM-4042*

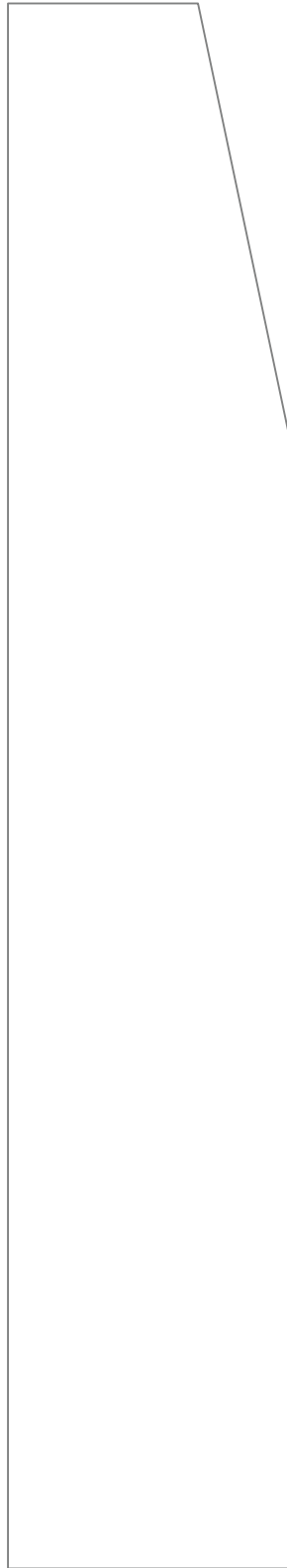

*PM-4041*

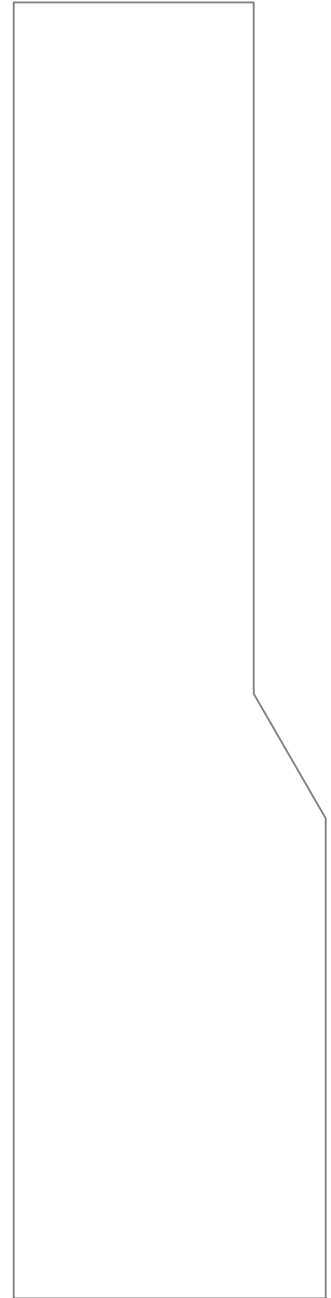

*PM-4037*

*PIERCE & PIERCE MILLWORK*

*FULL SCALE*

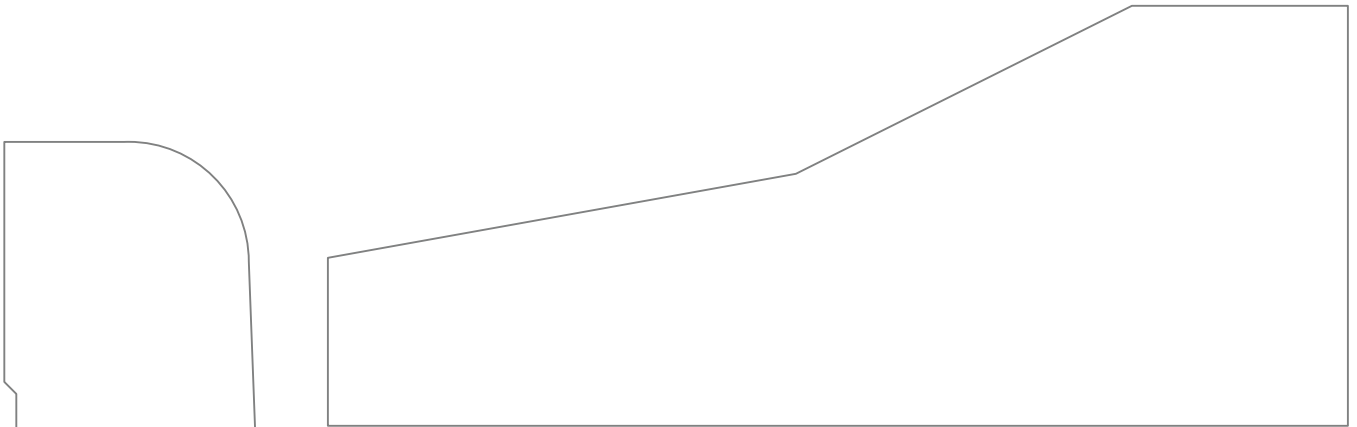

*PM-4054*

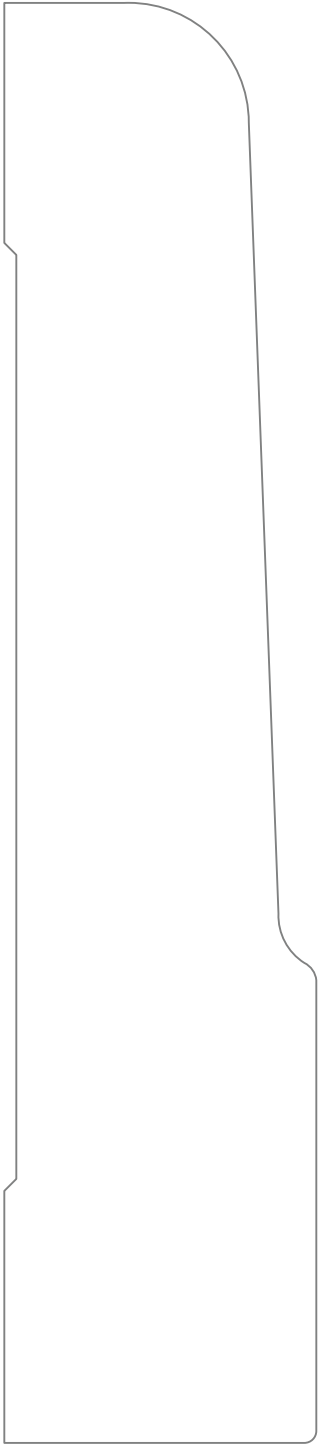

*PM-4052*

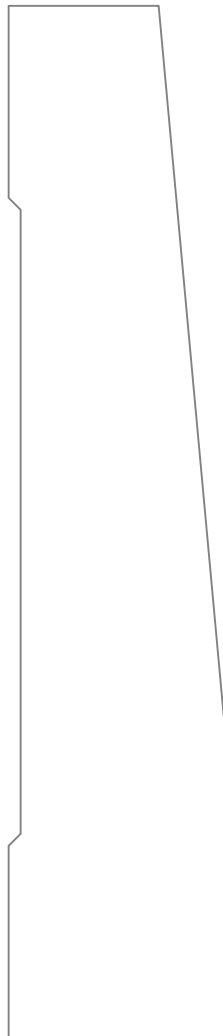

*PM-4043*

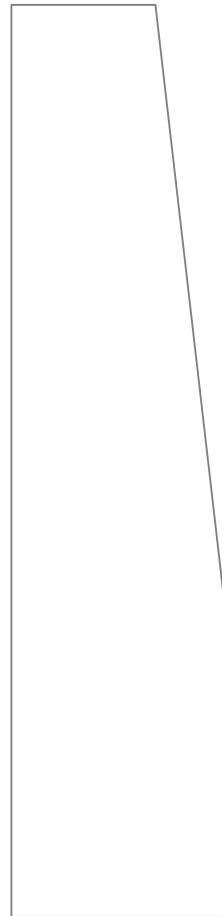

*PM-4055*

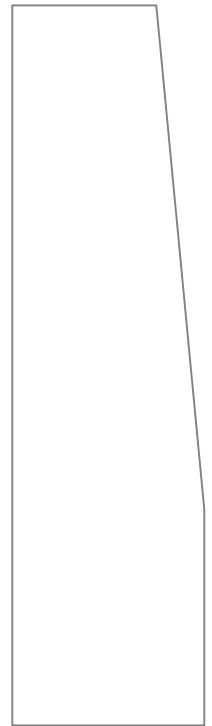

*PM-4056*

*PIERCE & PIERCE MILLWORK*

*FULL SCALE*

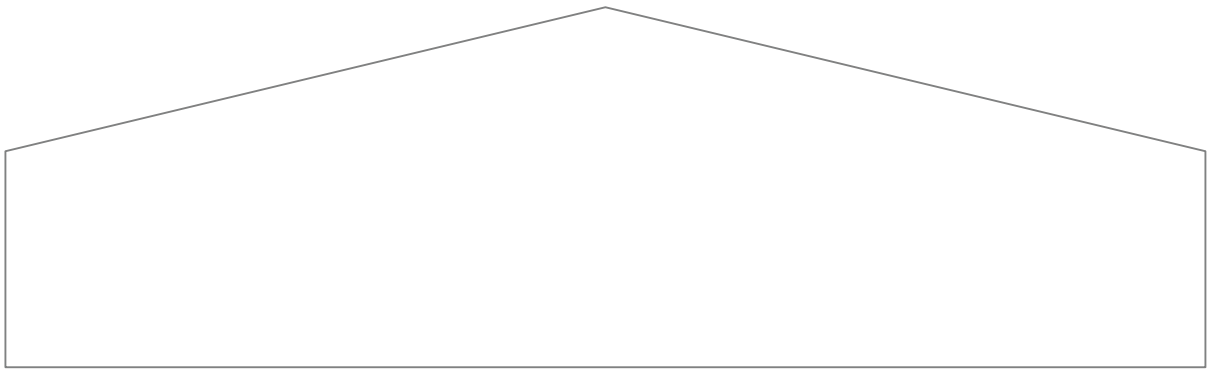

*PM-4053*

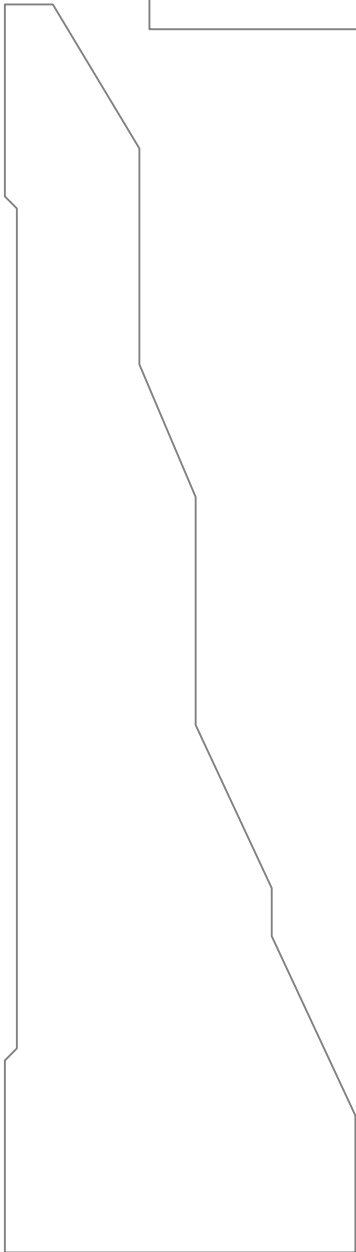

*PM-4045*

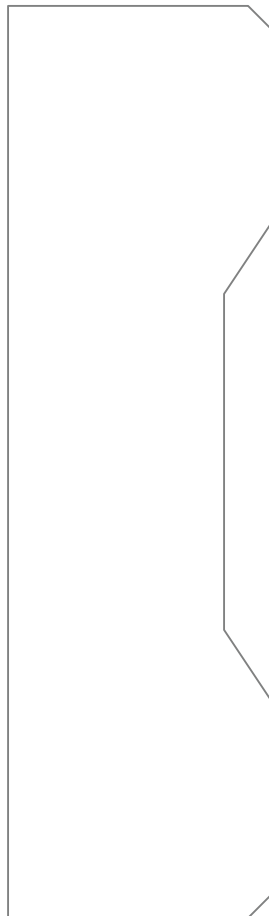

*PM-4047*

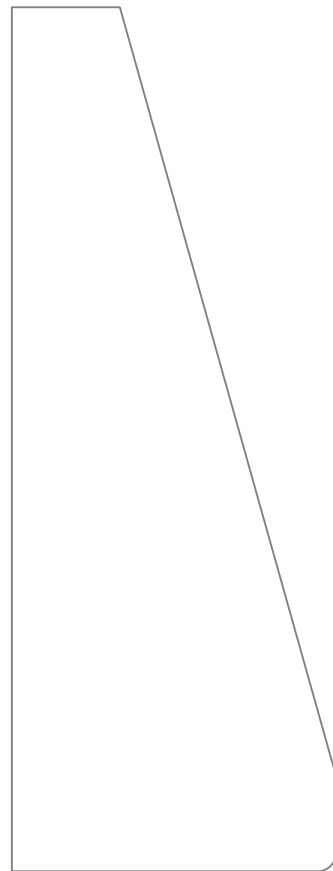

*PM-4050*

*PIERCE & PIERCE MILLWORK*

*FULL SCALE*

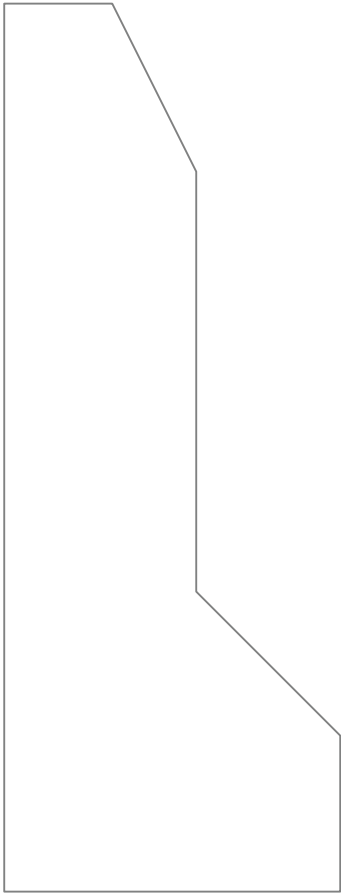

*PM-4058*

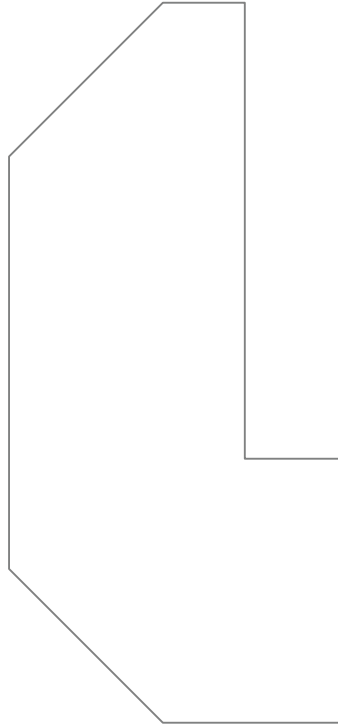

*PM-4057*

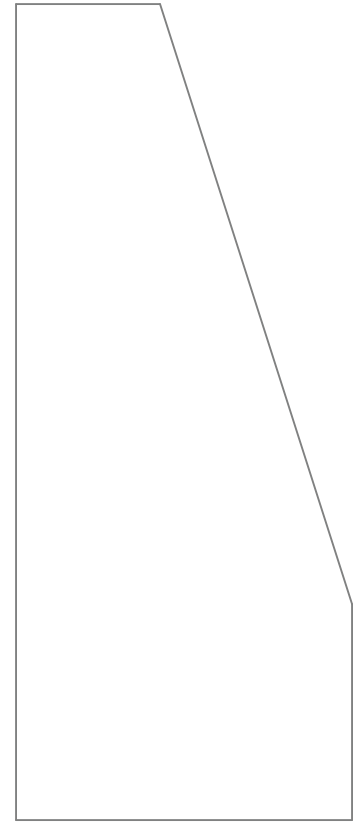

*PM-4059*

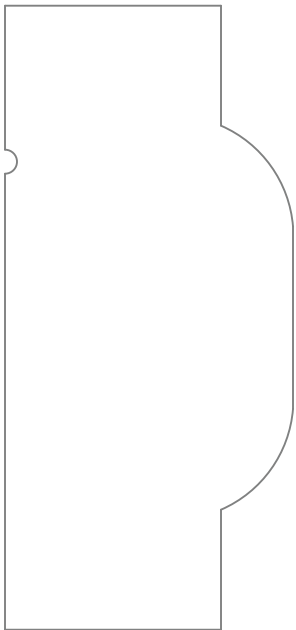

*PM-4066*

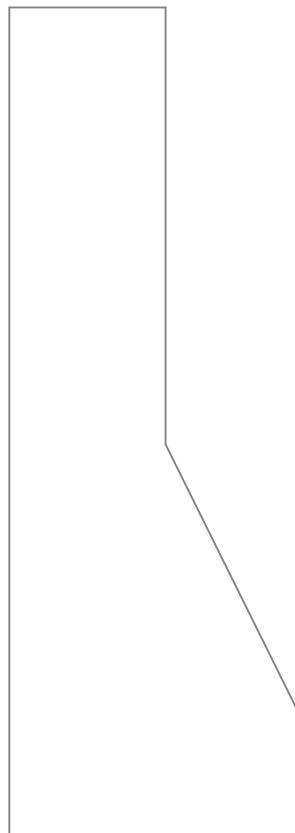

*PM-4082*

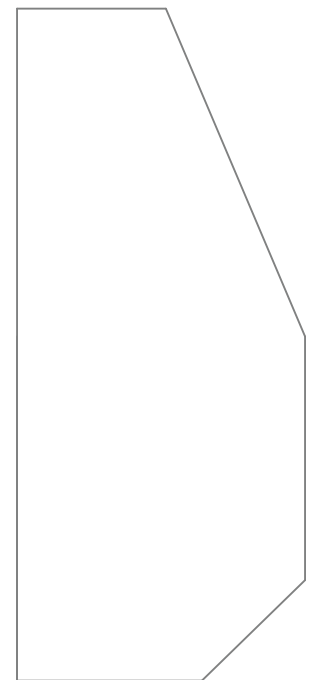

*PM-4076*



*PIERCE & PIERCE MILLWORK*

*FULL SCALE*

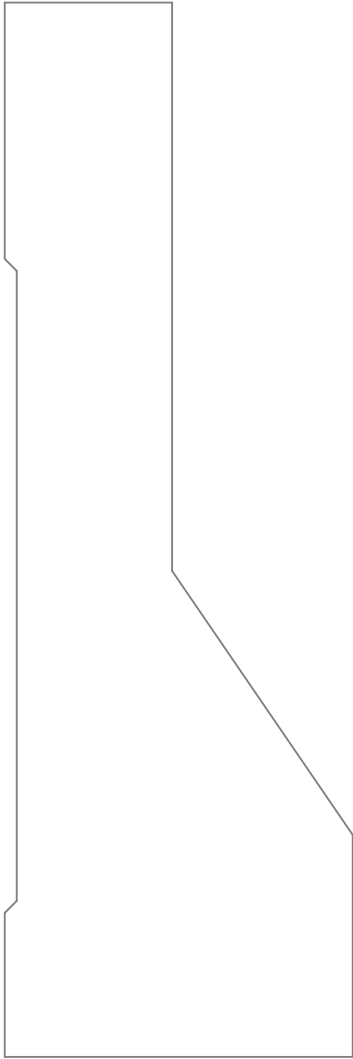

*PM-4061*

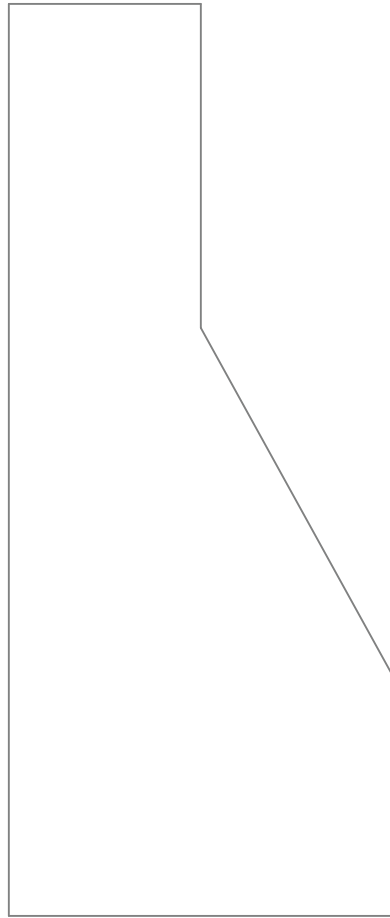

*PM-4064*

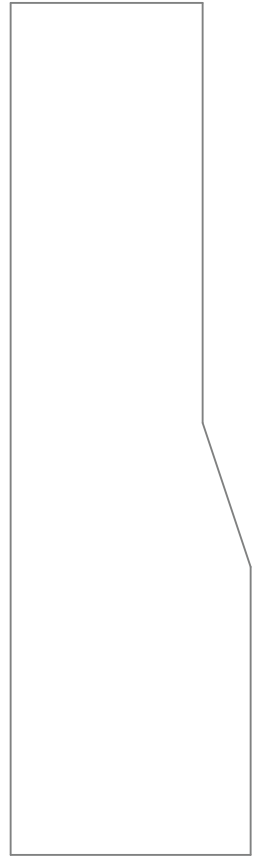

*PM-4060*

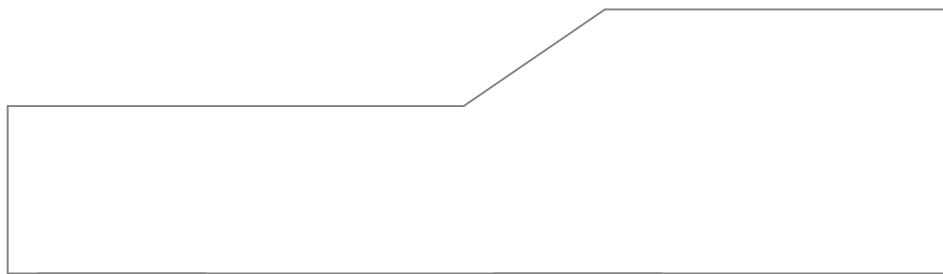

*PM-4068*

*PIERCE & PIERCE MILLWORK*

*FULL SCALE*

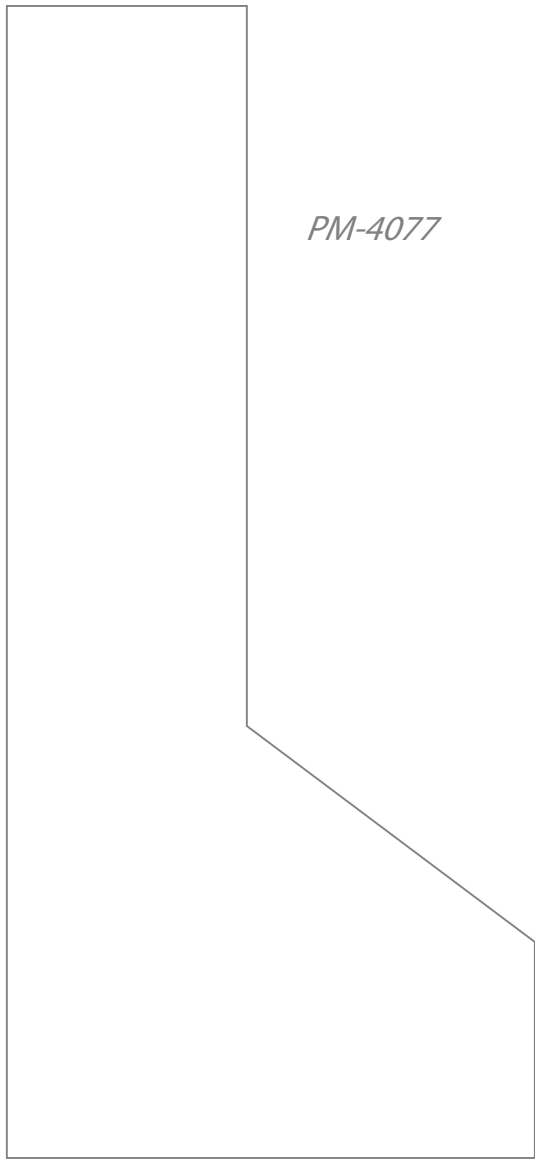

*PM-4077*

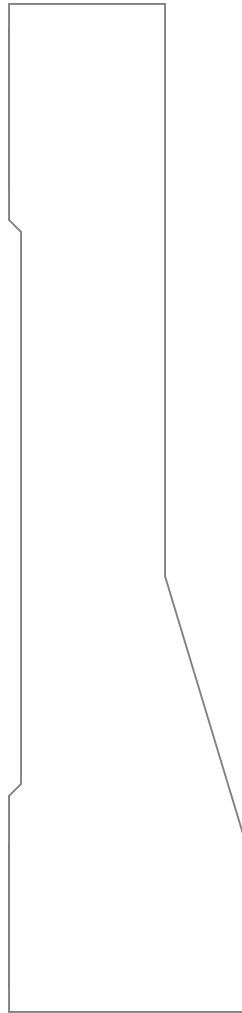

*PM-4092*

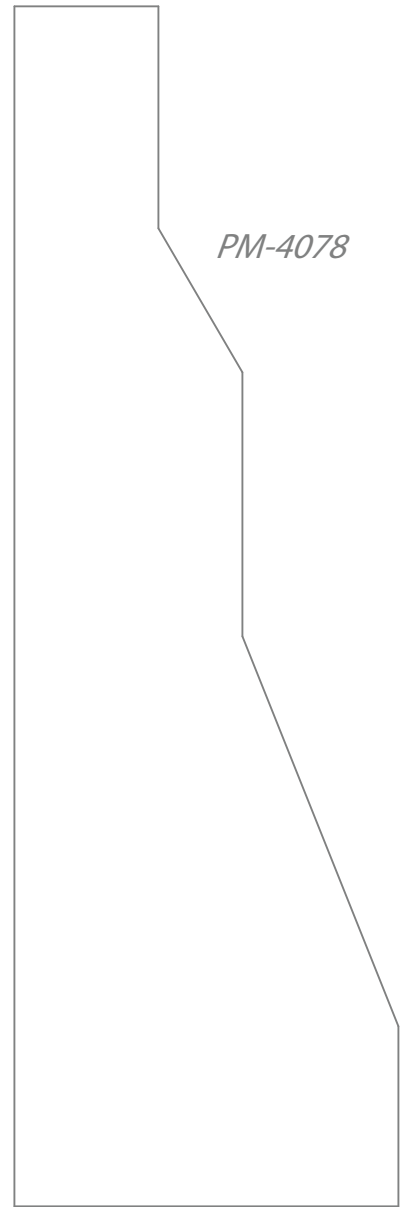

*PM-4078*

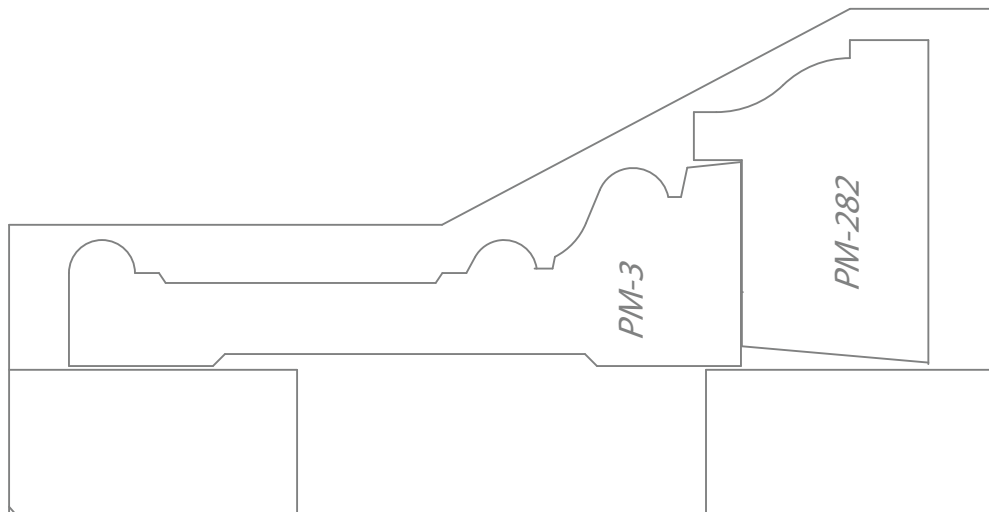

*PM-4065*

*PM-3*

*PM-282*

*PIERCE & PIERCE MILLWORK*

*FULL SCALE*

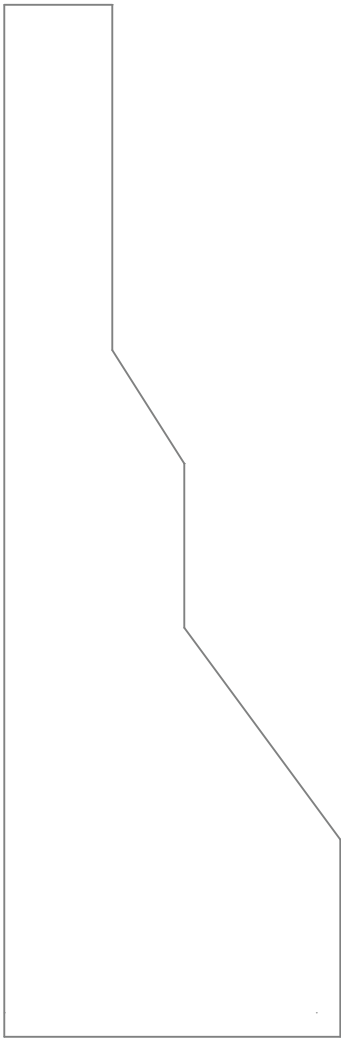

*PM-4081*

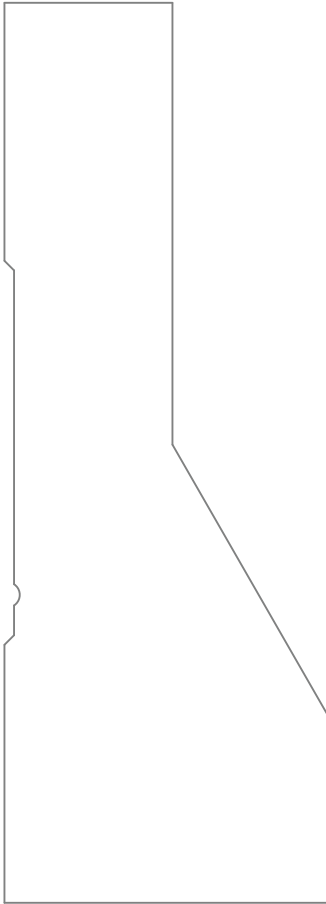

*PM-4084*

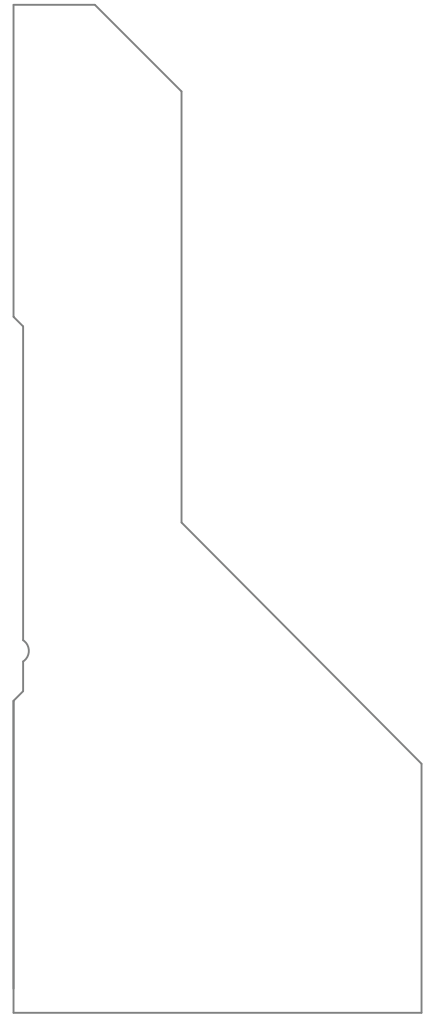

*PM-4085*

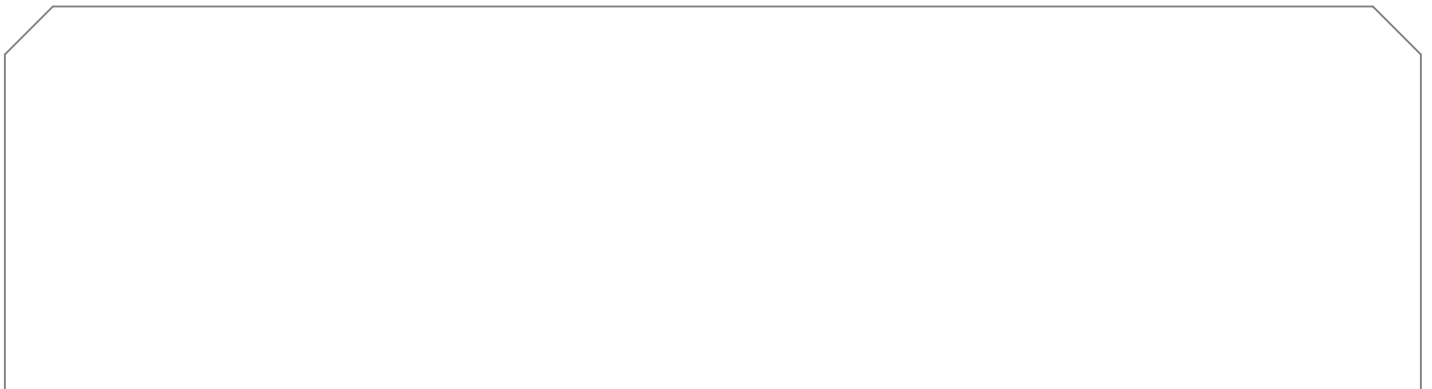

*PM-4094*

*PIERCE & PIERCE MILLWORK*

*FULL SCALE*

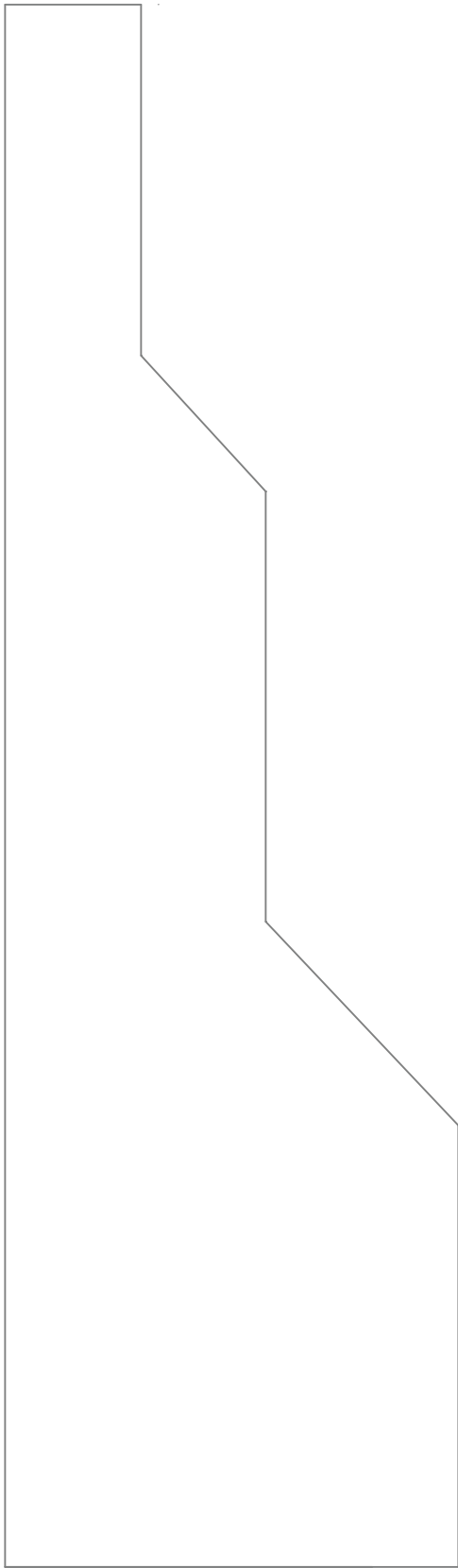

*PM-4079*

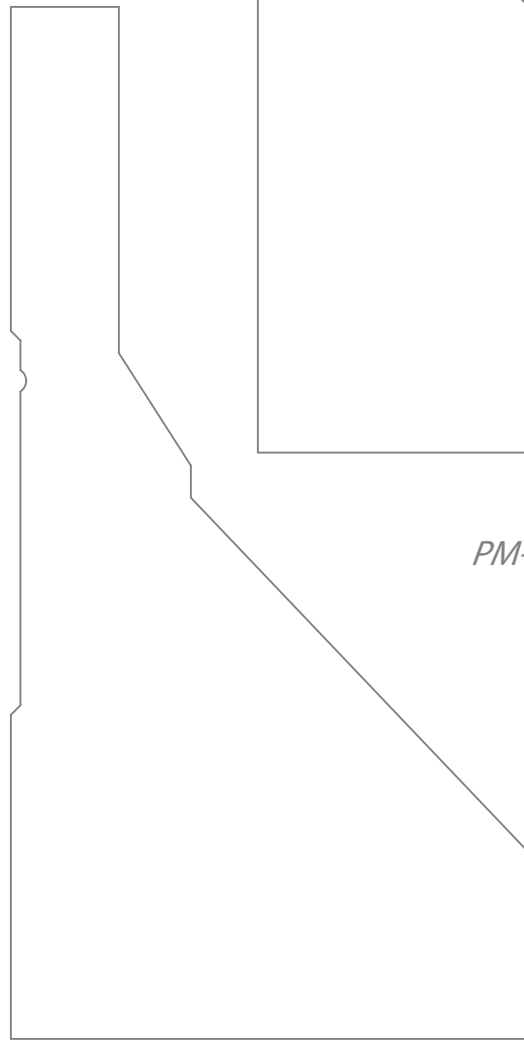

*PM-4089*

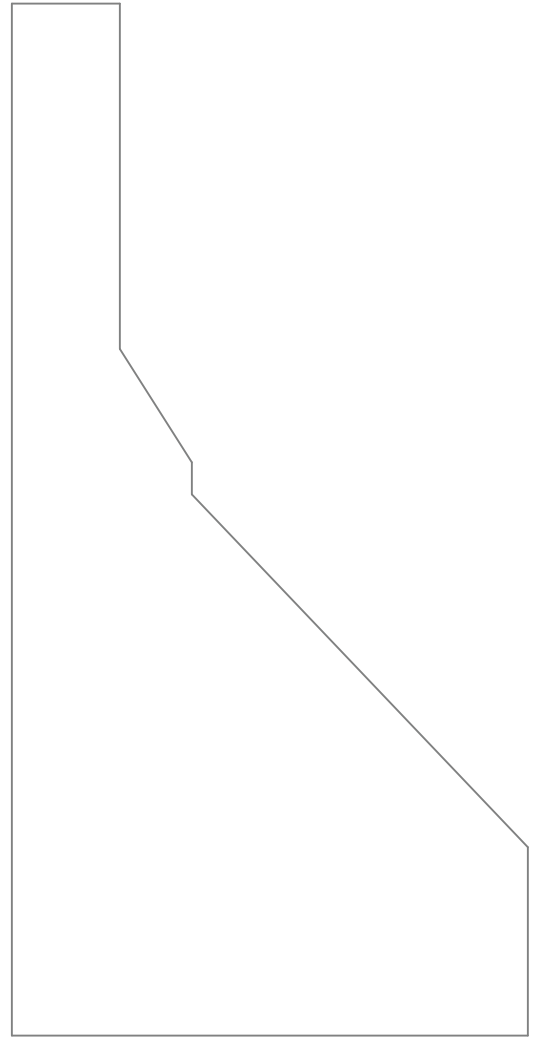

*PM-4090*

*PIERCE & PIERCE MILLWORK*

*FULL SCALE*

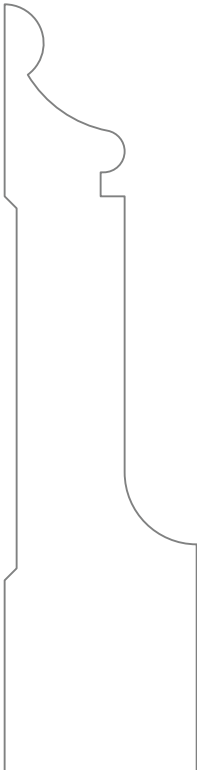

*PM-4501*



*PM-4502B*



*PM-4543*



*PM-4551*



*PM-4546*



*PM-4547*



*PM-4552*



*PM-4553*



*PM-4555*

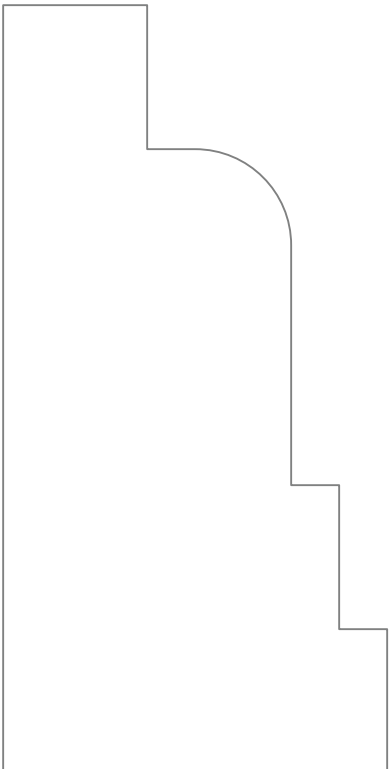

*PM-4541*

*PIERCE & PIERCE MILLWORK*

*FULL SCALE*

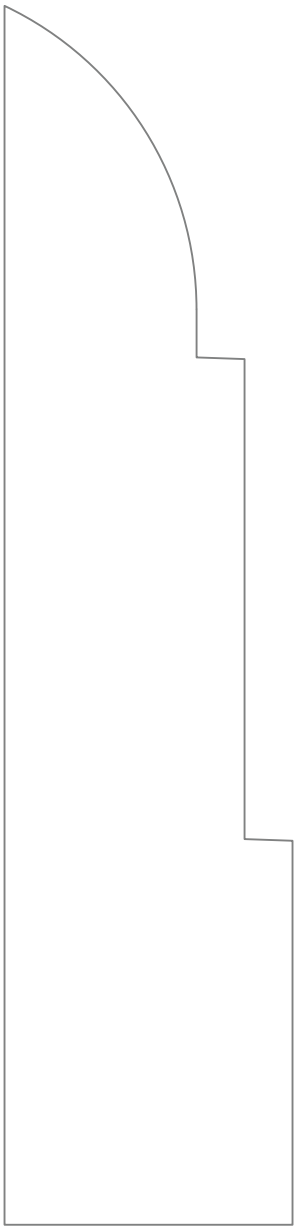

*PM-4539*

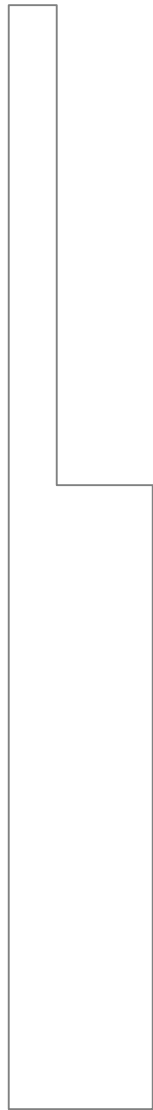

*PM-4544*

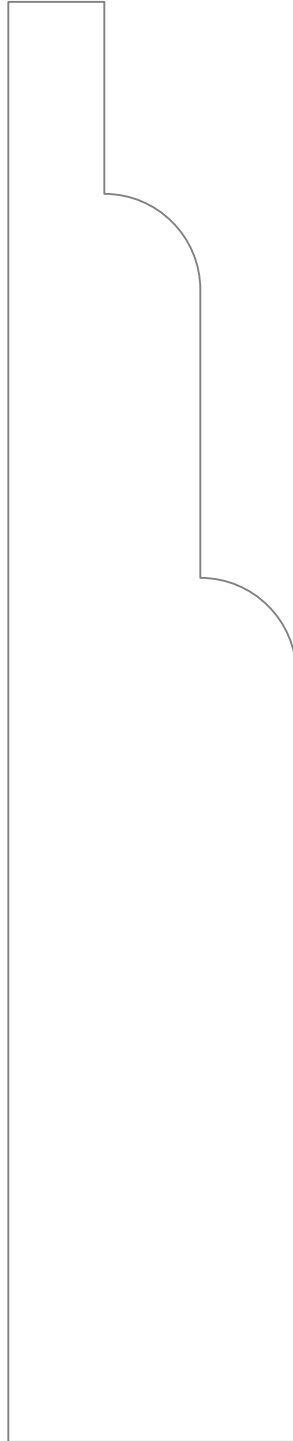

*PM-4548*



*PM-4549*

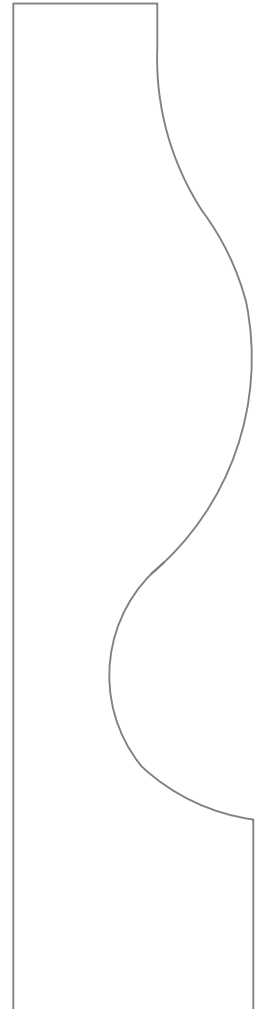

*PM-4566*

# PIERCE & PIERCE MILLWORK

FULL SCALE

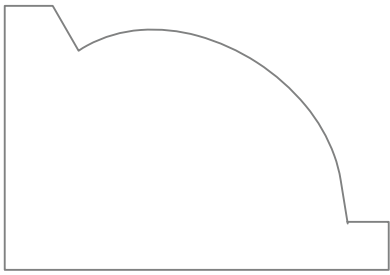

PM-4538

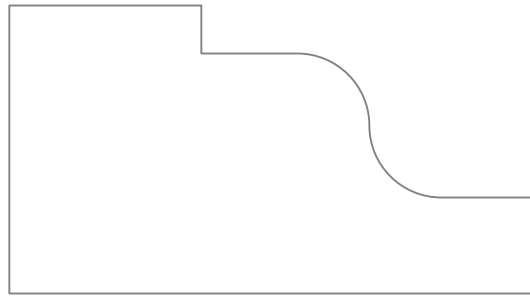

PM-4542

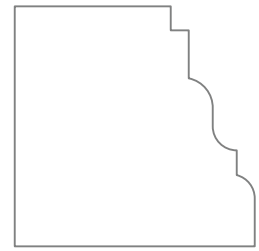

PM-4565

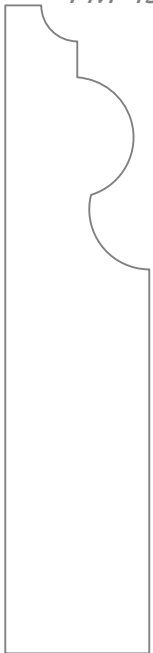

PM-4562



PM-4550



PM-4554



PM-4557



PM-4558

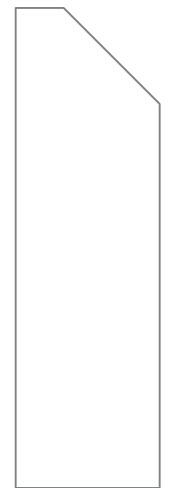

PM-4567

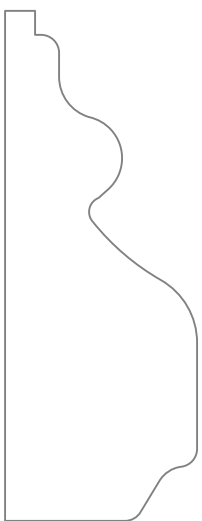

PM-4559

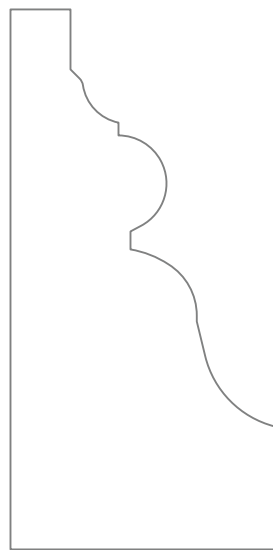

PM-4561

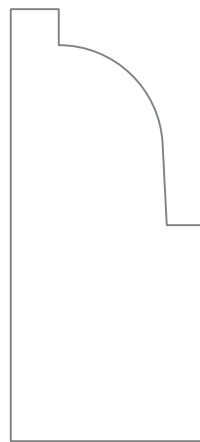

PM-4564

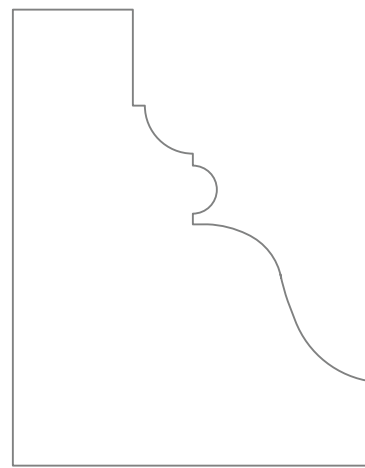

PM-4563



PM-4545

*PIERCE & PIERCE MILLWORK*

*FULL SCALE*



*PM-4581*

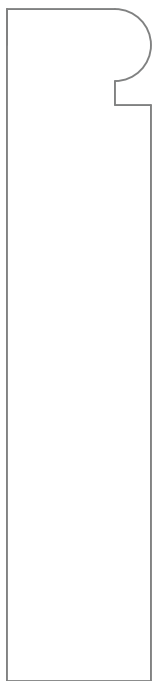

*PM-4586*



*PM-4584*

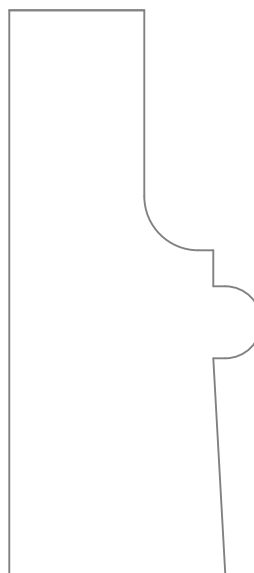

*PM-4582*

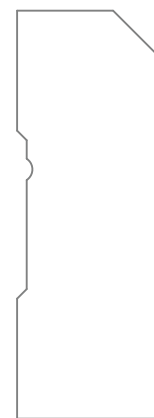

*PM-4588*



*PM-4573*



*PM-4576*

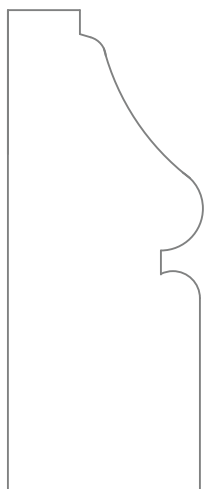

*PM-4574*

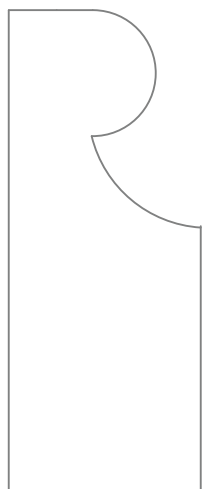

*PM-4575*

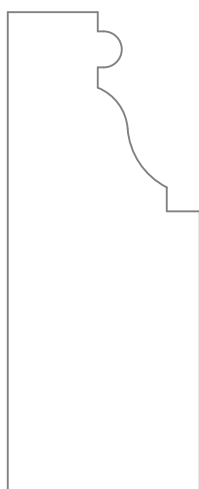

*PM-4578*

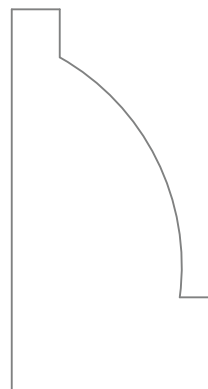

*PM-4572*



*PM-4577*



# PIERCE & PIERCE MILLWORK

FULL SCALE

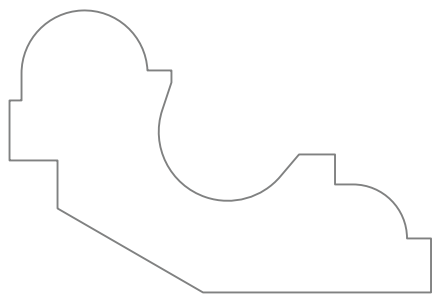

PM-5002

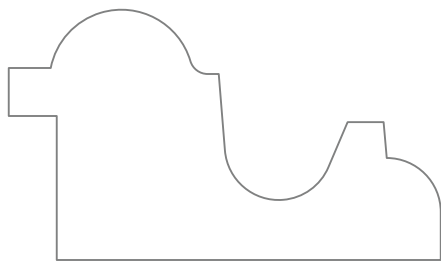

PM-5003

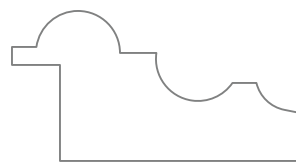

PM-5004



PM-5006

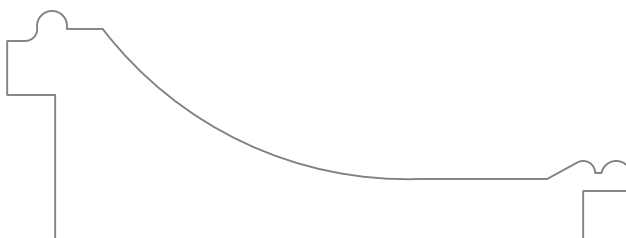

PM-5007

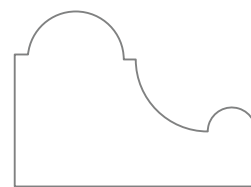

PM-5061

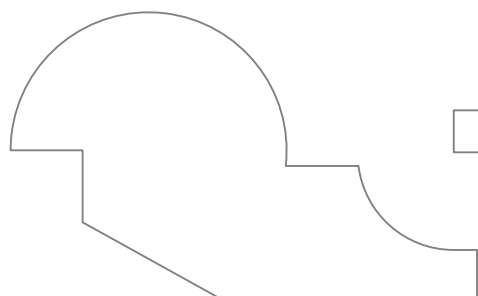

PM-5008

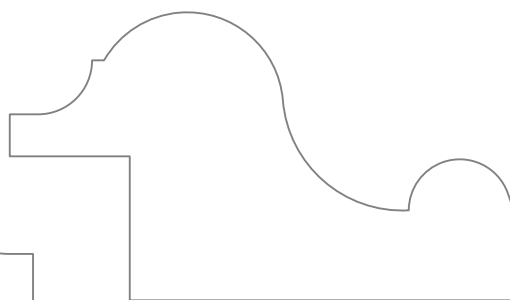

PM-5010

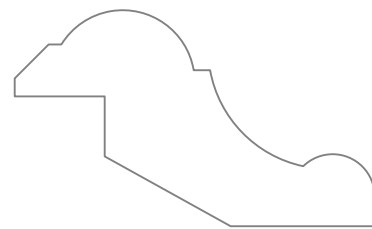

PM-5013

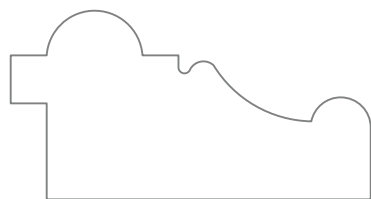

PM-5015

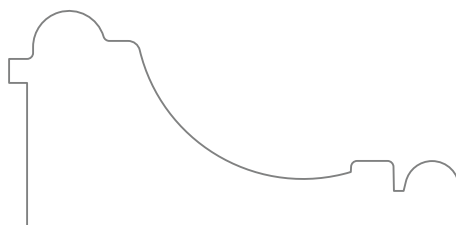

PM-5016

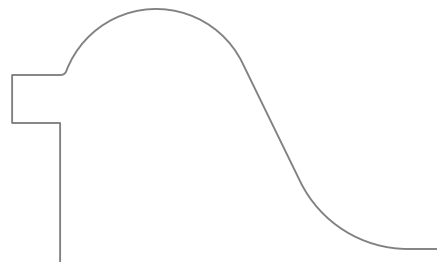

PM-5019

# PIERCE & PIERCE MILLWORK

FULL SCALE

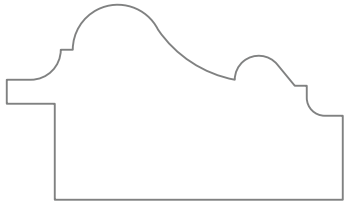

PM-5017

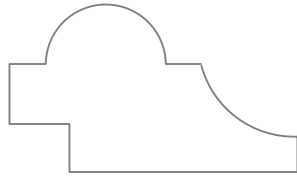

PM-5055

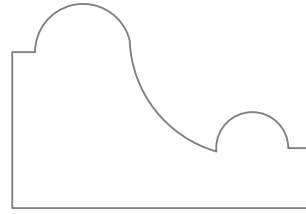

PM-5056

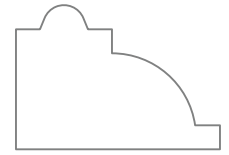

PM-5057

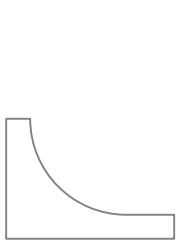

PM-5058

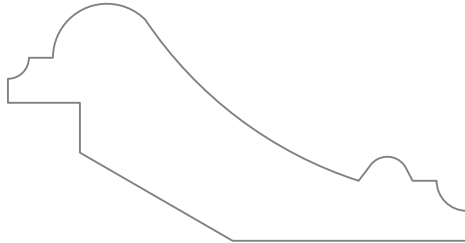

PM-5059

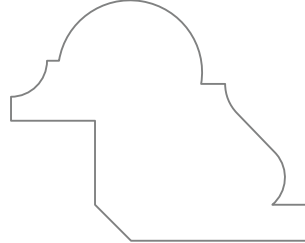

PM-5060

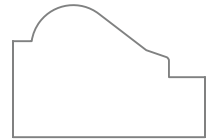

PM-5067

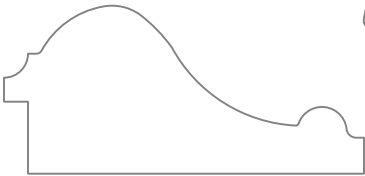

PM-5078

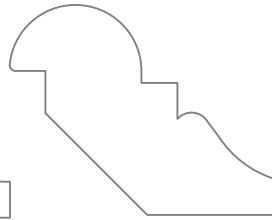

PM-5077

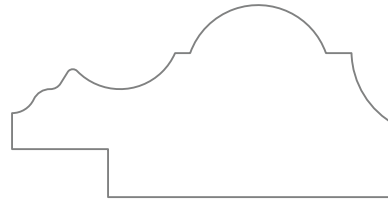

PM-5062

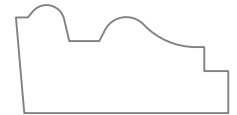

PM-5068

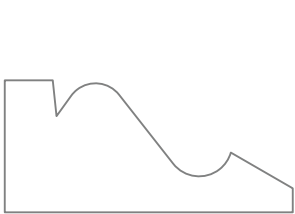

PM-5064

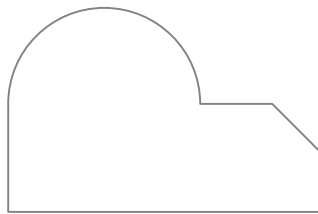

PM-5065

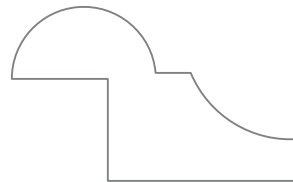

PM-5066

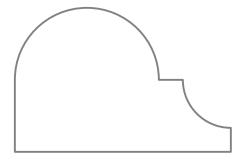

PM-5069

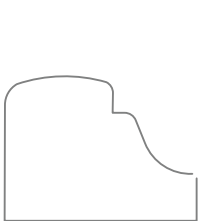

PM-5071

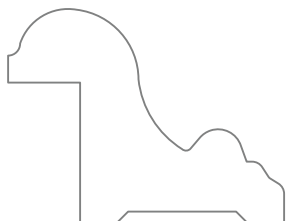

PM-5072

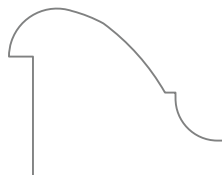

PM-5074

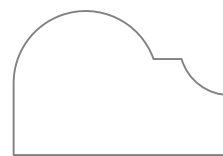

PM-5076

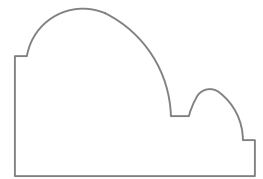

PM-5082

*PIERCE & PIERCE MILLWORK*

*FULL SCALE*

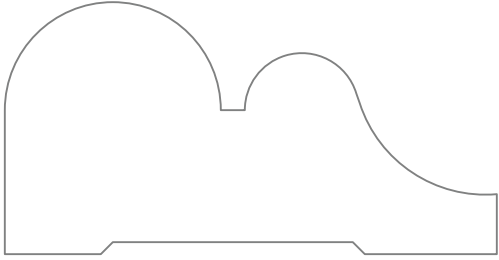

*PM-5075*



*PM-5085*

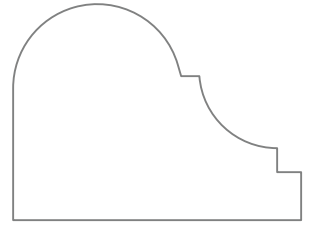

*PM-5081*

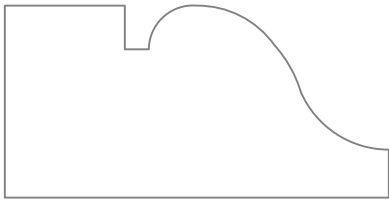

*PM-5086*

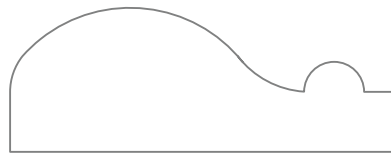

*PM-5083*

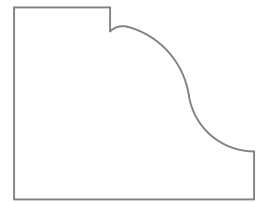

*PM-5089*

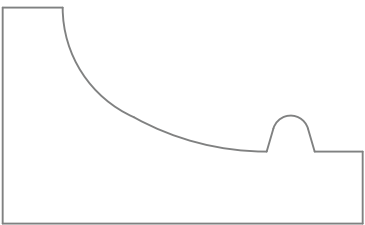

*PM-5095*

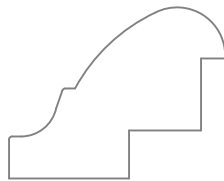

*PM-5088*

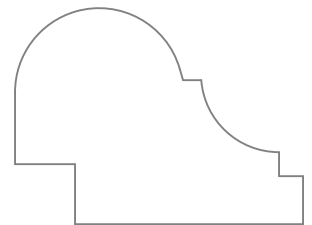

*PM-5097*

# PIERCE & PIERCE MILLWORK

FULL SCALE

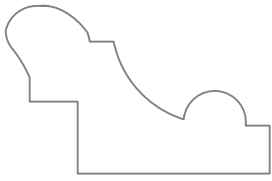

PM-5100

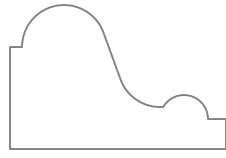

PM-5101

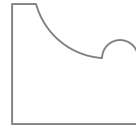

PM-5102

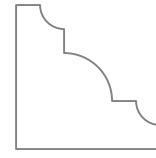

PM-5103

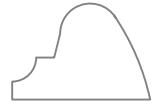

PM-5105

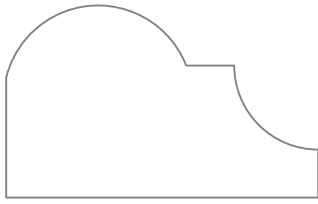

PM-5104

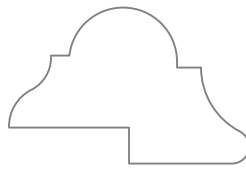

PM-5106

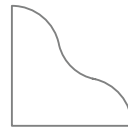

PM-5108

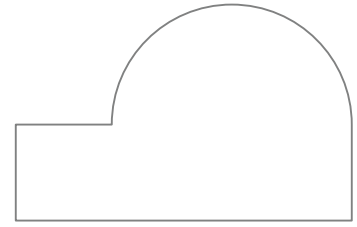

PM-5107

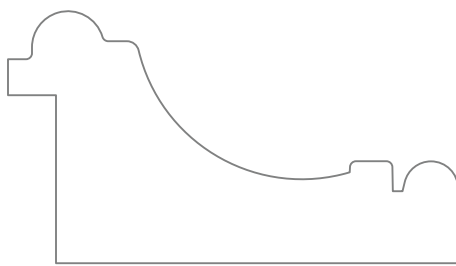

PM-5109

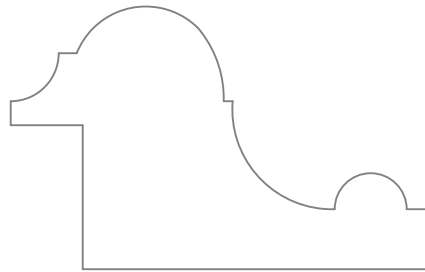

PM-5115

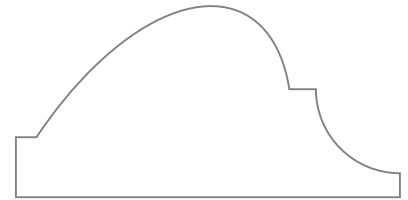

PM-5121

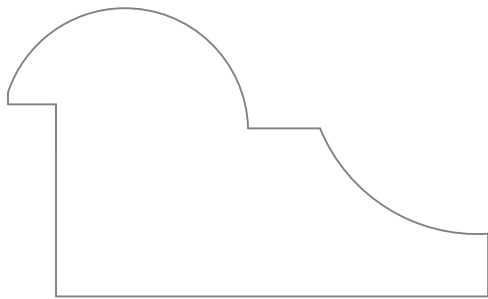

PM-5114



PM-5110



PM-5112

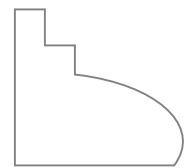

PM-5120

*PIERCE & PIERCE MILLWORK*

*FULL SCALE*



*PM-5145*



*PM-5144*



*PM-5134*

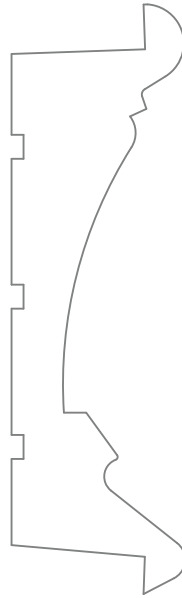

*PM-5126*

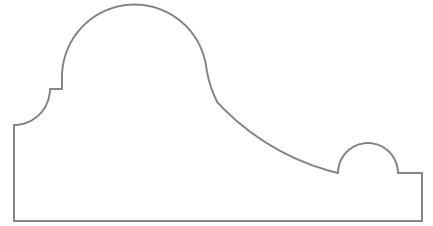

*PM-5116*

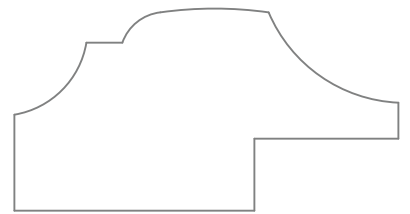

*PM-5122*

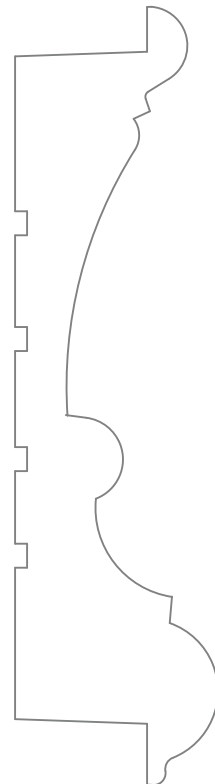

*PM-5127*

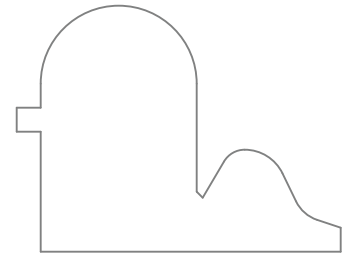

*PM-5167*

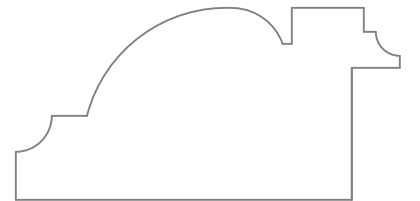

*PM-5156*

# PIERCE & PIERCE MILLWORK

FULL SCALE

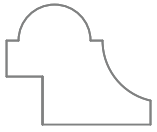

PM-5124

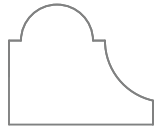

PM-5125

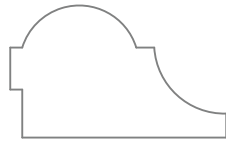

PM-5133

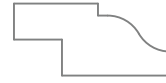

PM-5148

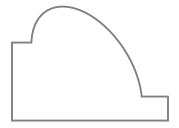

PM-5163

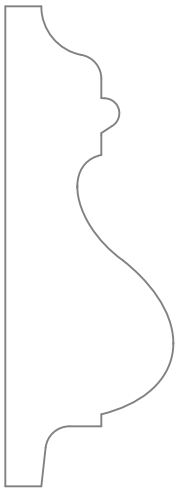

PM-5165

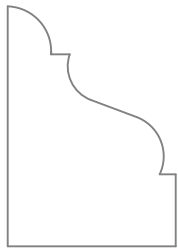

PM-5164

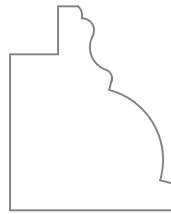

PM-5168

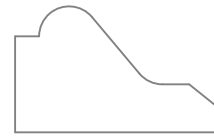

PM-5174

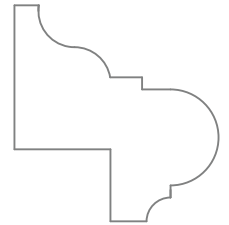

PM-5173



PM-5171

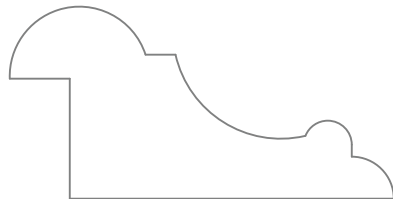

PM-5166

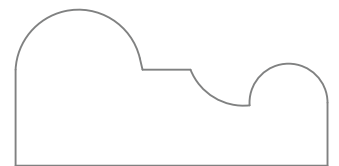

PM-5172

# PIERCE & PIERCE MILLWORK

FULL SCALE

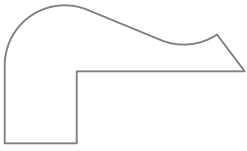

PM-5508

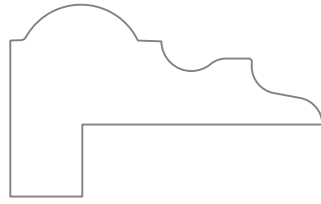

PM-5509

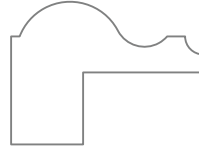

PM-5513

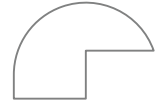

PM-5515

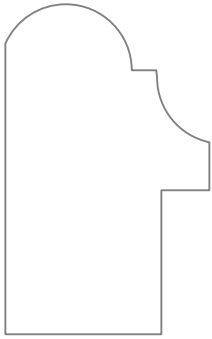

PM-5507

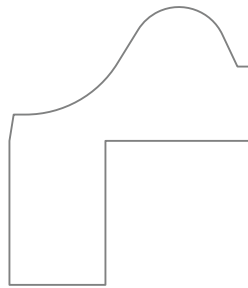

PM-5514

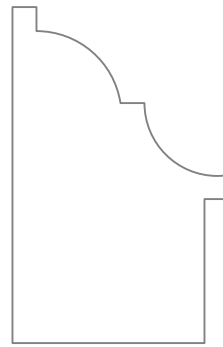

PM-5516

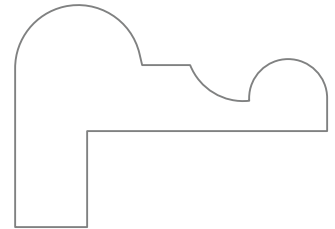

PM-5518

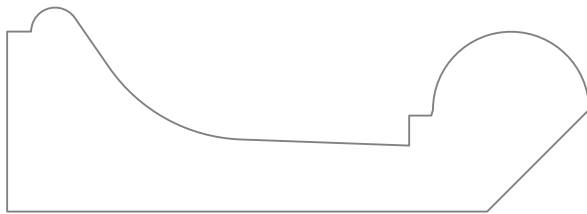

PM-9005



PM-9006

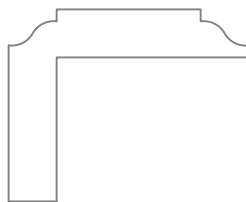

PM-9002

# PIERCE & PIERCE MILLWORK

FULL SCALE



PM-6001



PM-6027



PM-6009



PM-6021



PM-6051



PM-6028



PM-6020



PM-6022



PM-6035



PM-6024



PM-6038

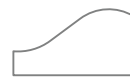

PM-6004



PM-6032

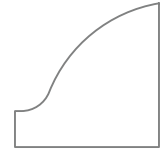

PM-6023



PM-6045



PM-6005



PM-6011M



PM-6049



PM-6050



PM-6030



PM-6048



PM-6025



PM-6026



PM-6046



PM-6047



PM-6037



# PIERCE & PIERCE MILLWORK

FULL SCALE



*PM-6031*



*PM-6033*



*PM-6036*

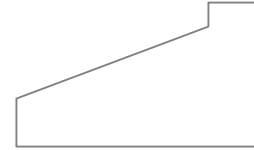

*PM-6034*

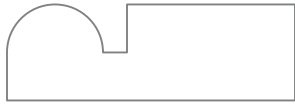

*PM-6039*



*PM-6040*



*PM-6041*



*PM-6044*



*PM-6043*



*PM-6042*

# PIERCE & PIERCE MILLWORK

## FULL SCALE

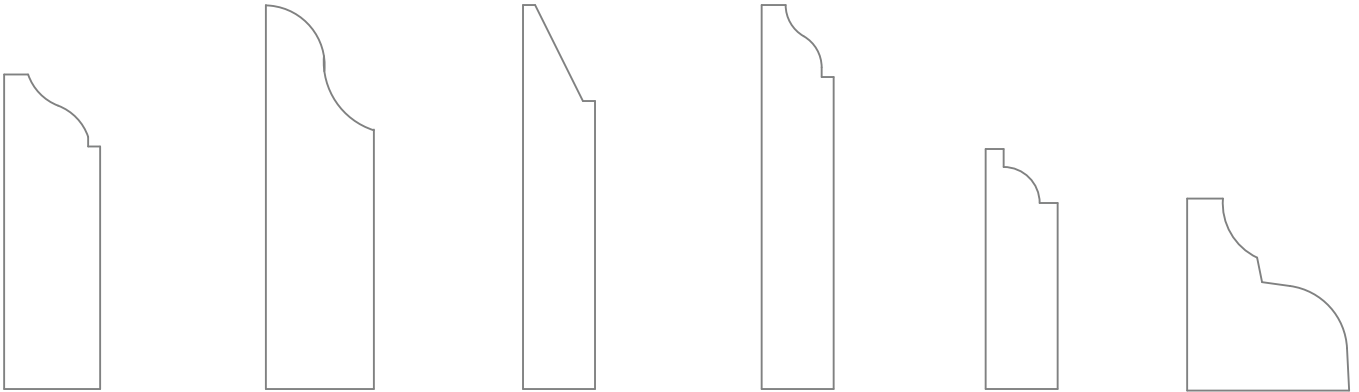

*PM-6052*

*PM-6063*

*PM-6078*

*PM-6061*

*PM-6062*

*PM-6054*

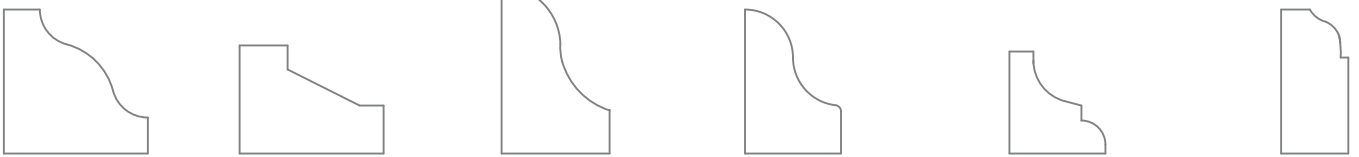

*PM-6080*

*PM-6081*

*PM-6071*

*PM-6072*

*PM-6073*

*PM-6053*



*PM-6077*

# PIERCE & PIERCE MILLWORK

FULL SCALE

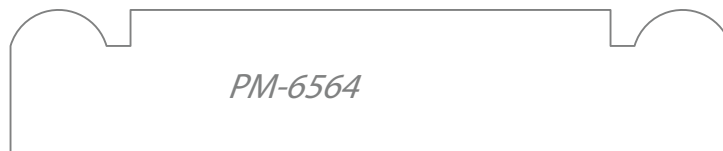
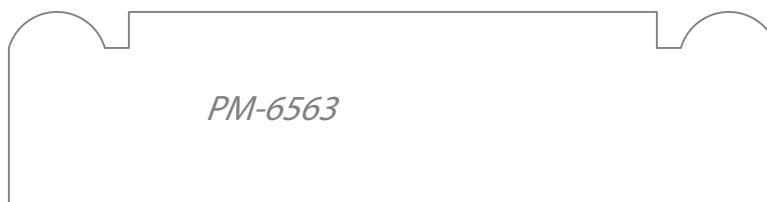
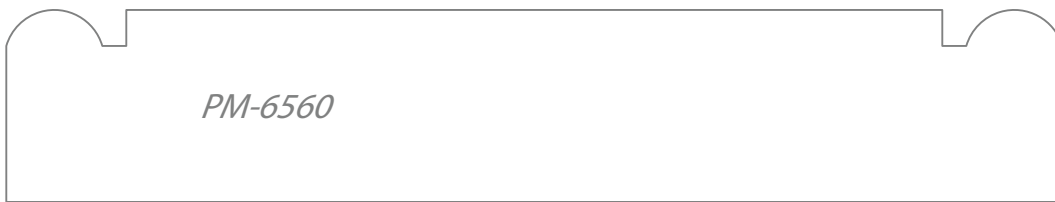
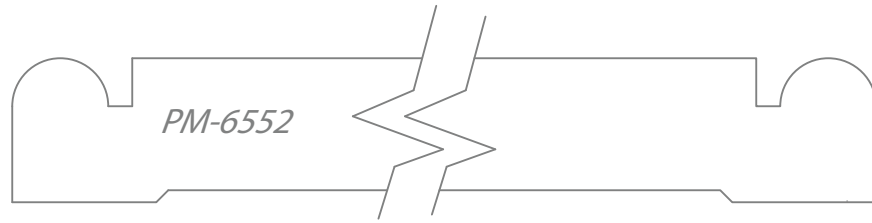

*PIERCE & PIERCE MILLWORK*

*FULL SCALE*

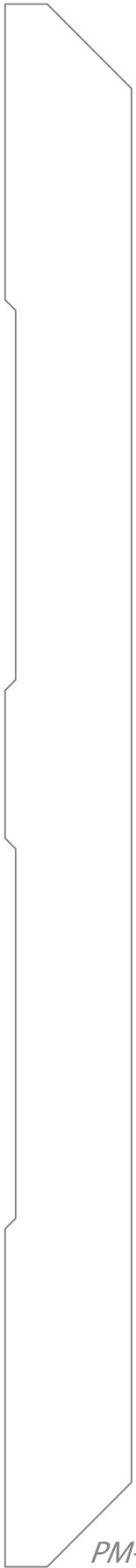

*PM-6572*

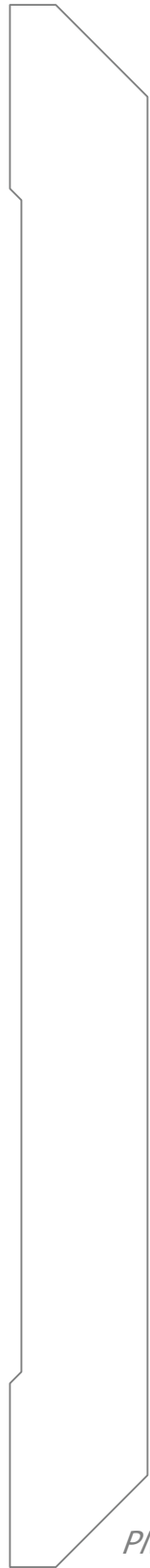

*PM-6570*



*PM-6569*



*PM-6571*



*PM-6568*

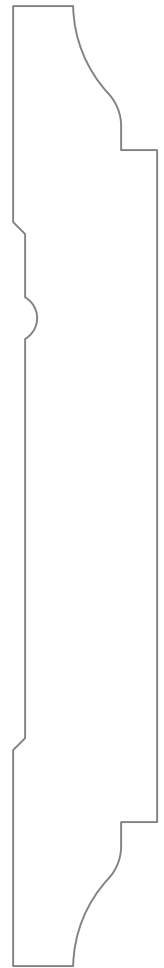

*PM-6573*

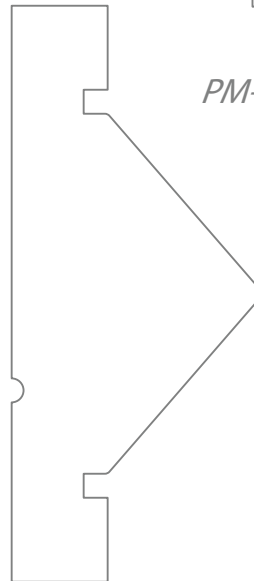

*PM-6523*

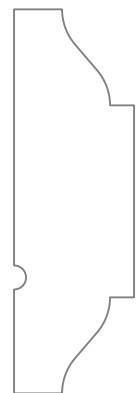

*PM-6549*

# PIERCE & PIERCE MILLWORK

FULL SCALE

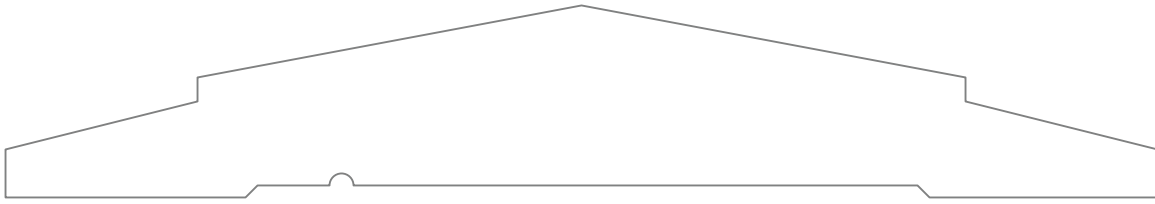

PM-6555

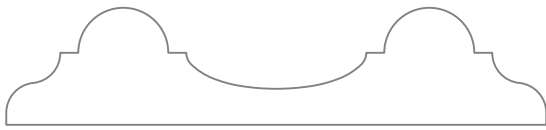

PM-6502



PM-6507



PM-6508



PM-6512



PM-6514

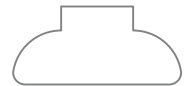

PM-6556

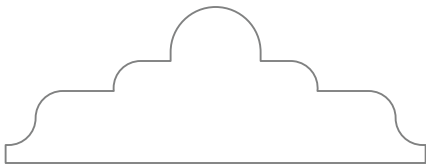

PM-6509

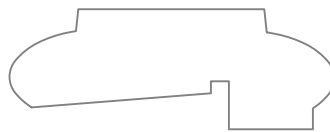

PM-6544



PM-6515



PM-6520



PM-6521



PM-6522



PM-6545

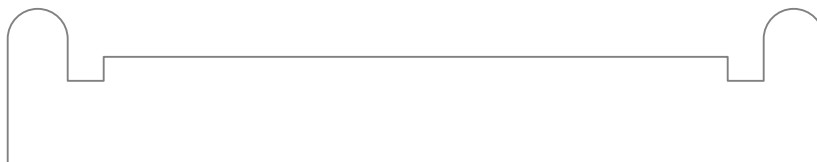

PM-6543

# PIERCE & PIERCE MILLWORK

FULL SCALE

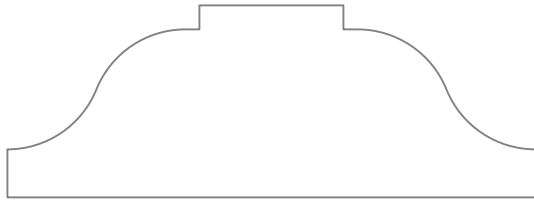

PM-6540



PM-6542



PM-6547

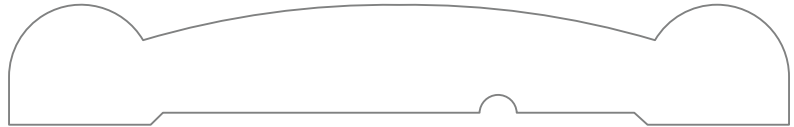

PM-6548



PM-6554



PM-6553

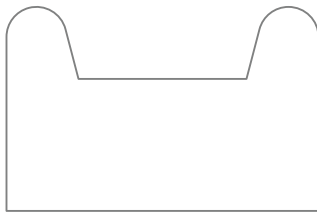

PM-6551



PM-6546

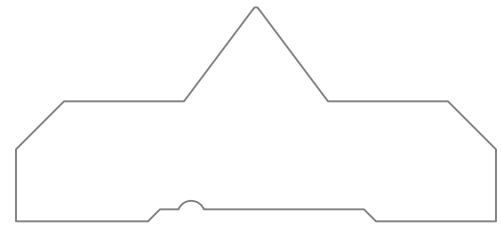

PM-6558

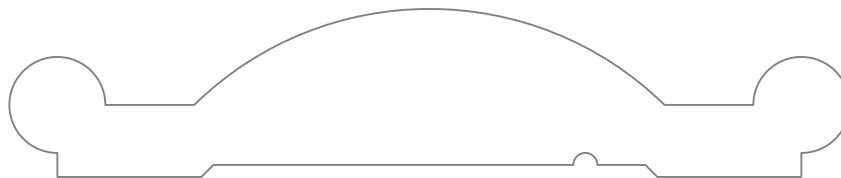

PM-6550

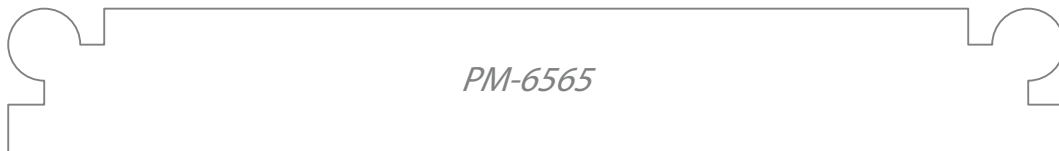

PM-6565

*PIERCE & PIERCE MILLWORK*

*FULL SCALE*

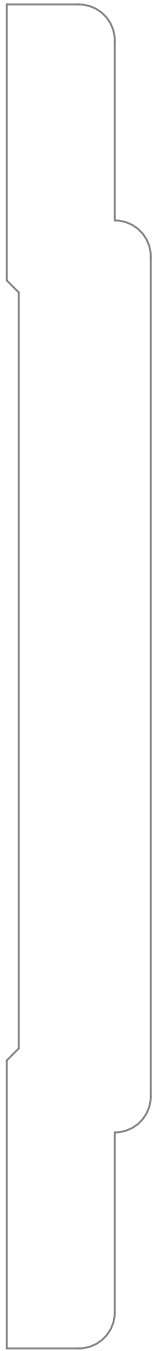

*PM-6587*



*PM-6576*



*PM-6582*



*PM-6578*

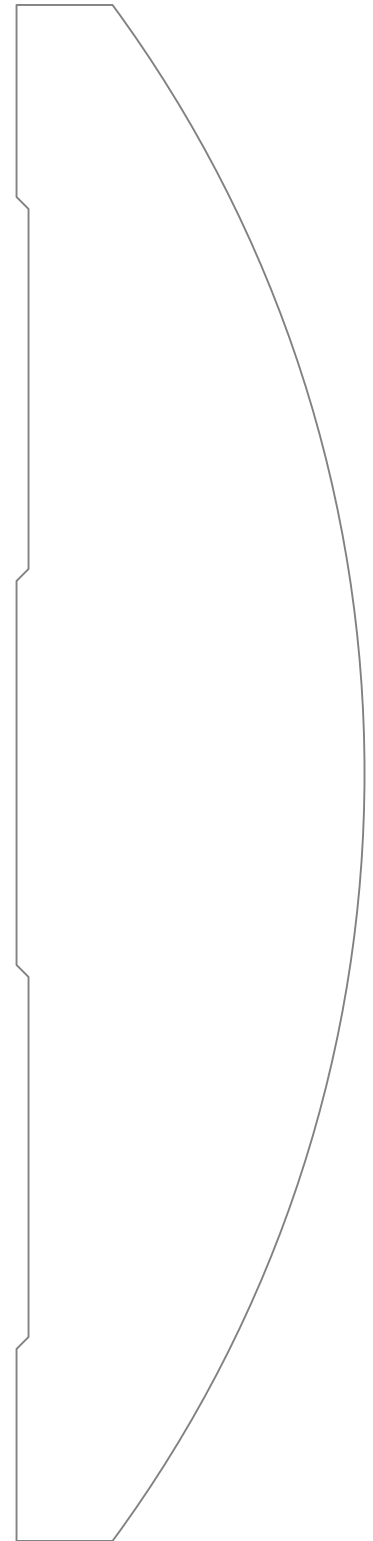

*PM-6557*

# PIERCE & PIERCE MILLWORK

FULL SCALE



PM-6588



PM-6574



PM-6586



PM-6577



PM-6585



PM-6580



PM-6584



PM-6589

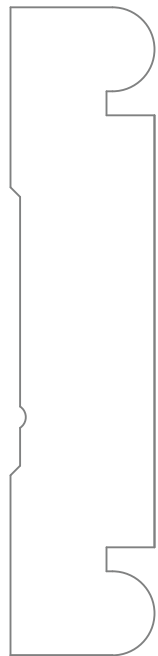

PM-6590

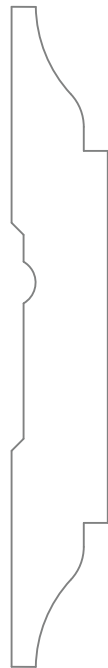

PM-6583



PM-6579



PM-6575



*PIERCE & PIERCE MILLWORK*

*FULL SCALE*

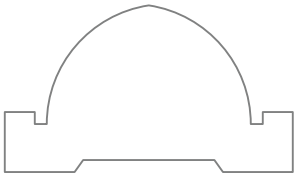

*PM-7062*



*PM-7074*



*PM-7051*



*PM-7057*

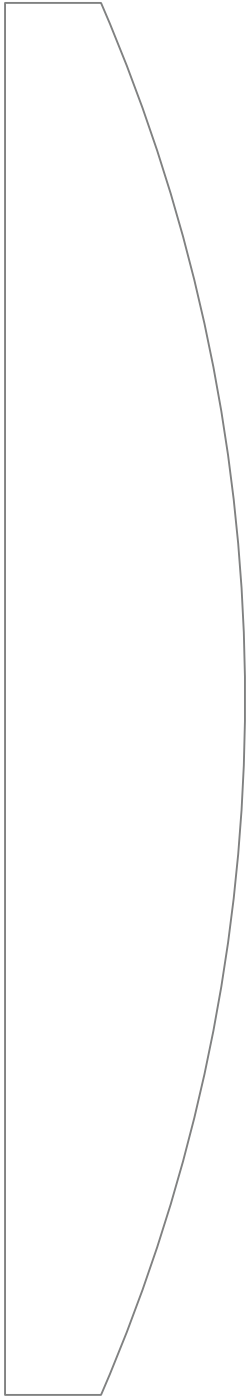

*PM-7058*

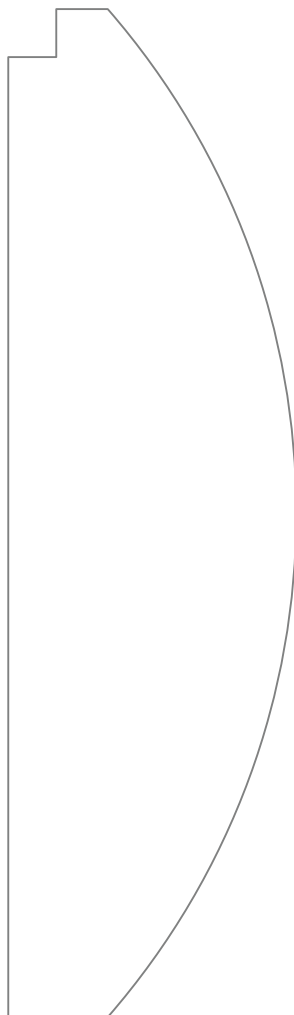

*PM-7060M*

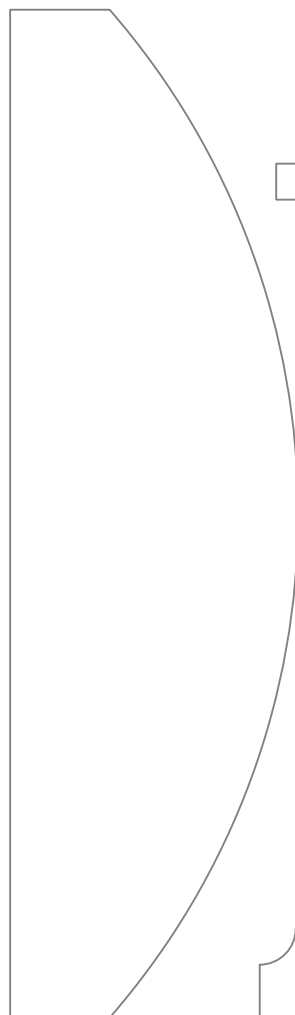

*PM-7060*



*PM-7059*

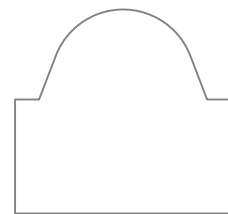

*PM-7065*

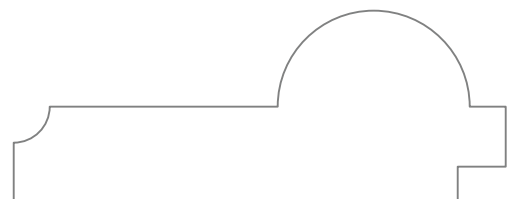

*PM-7050*

*PIERCE & PIERCE MILLWORK*

*FULL SCALE*

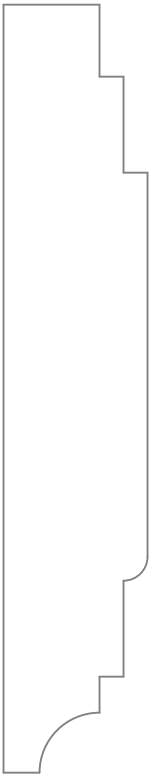

*PM-7054*

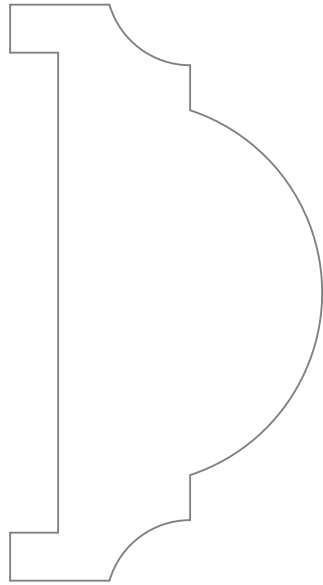

*PM-7052*

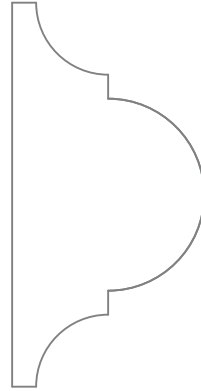

*PM-7079*

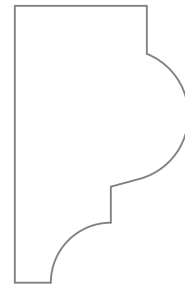

*PM-7049M*

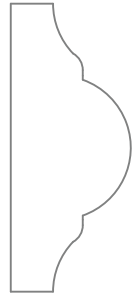

*PM-7069*



*PM-7071*



*PM-7077*



*PM-7084*



*PM-7076*



*PM-7075*

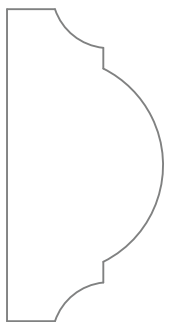

*PM-7068*

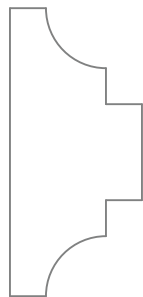

*PM-7055*



*PM-7070*



*PM-7082*

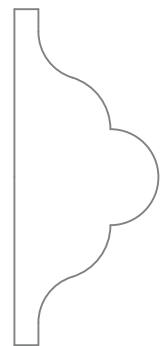

*PM-7083*

# PIERCE & PIERCE MILLWORK

FULL SCALE



PM-7073

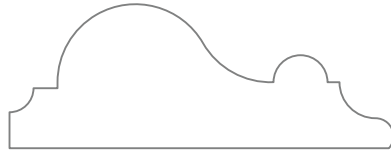

PM-7064



PM-7043



PM-7038

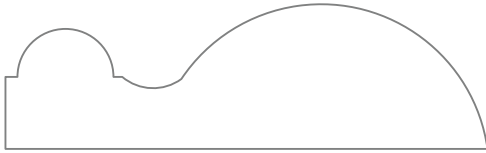

PM-7053

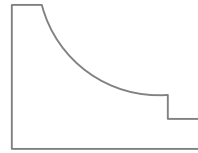

PM-7039

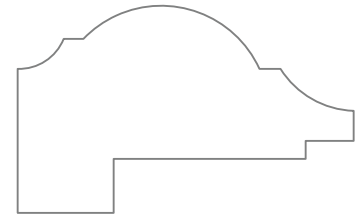

PM-7027E-M



PM-7041



PM-7042

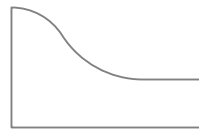

PM-7046

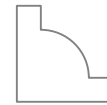

PM-7044

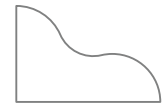

PM-7045

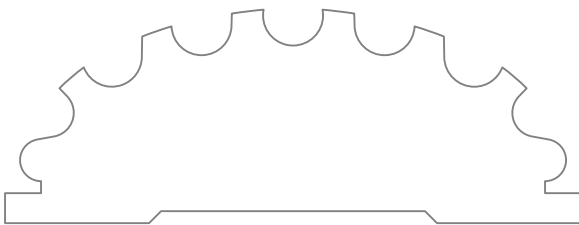

PM-7023



PM-7036



PM-7037



PM-7016E

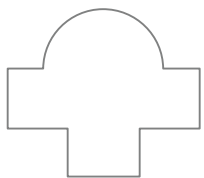

PM-7032

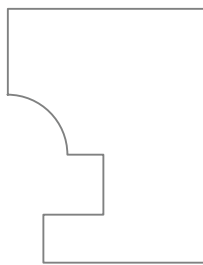

PM-7032F

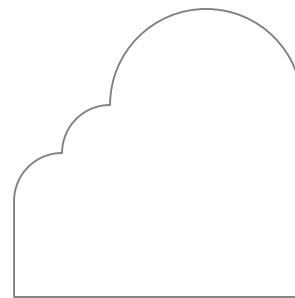

PM-7035

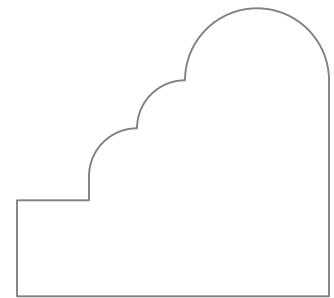

PM-7040

*PIERCE & PIERCE MILLWORK*

*FULL SCALE*

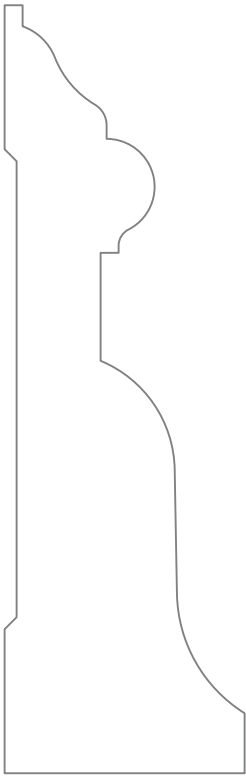

*PM-7501*

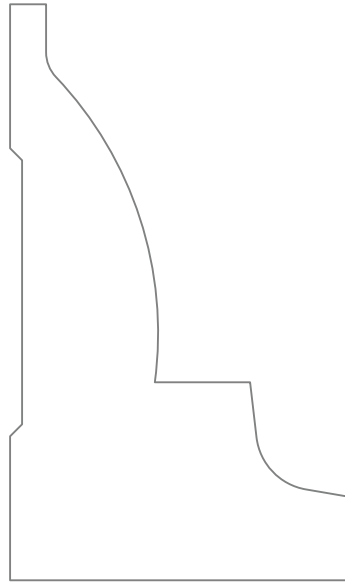

*PM-7502*

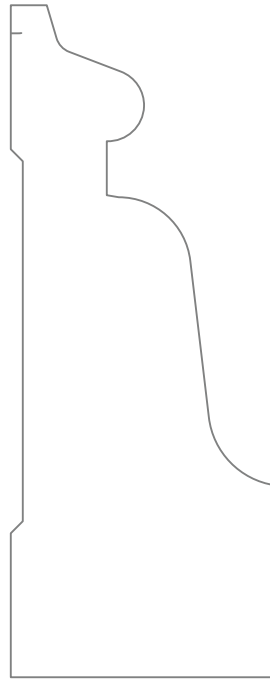

*PM-7503*

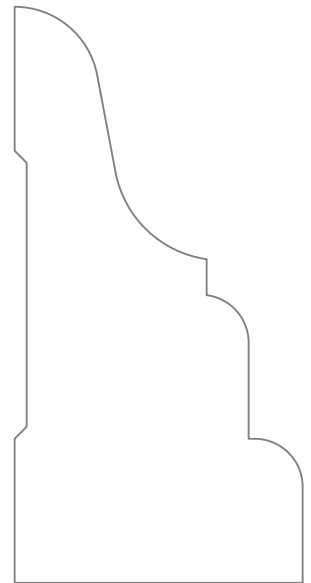

*PM-7504*

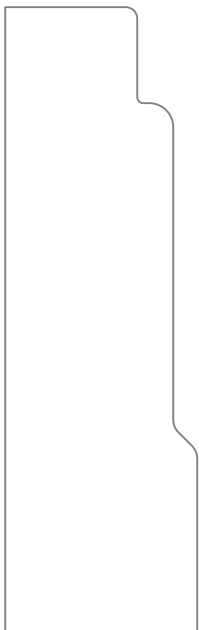

*PM-7508*

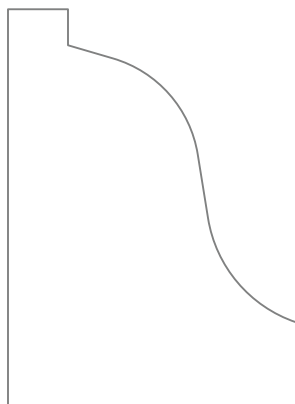

*PM-7507*



*PM-7505*

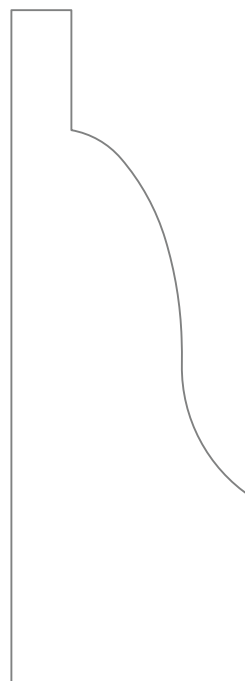

*PM-7509*

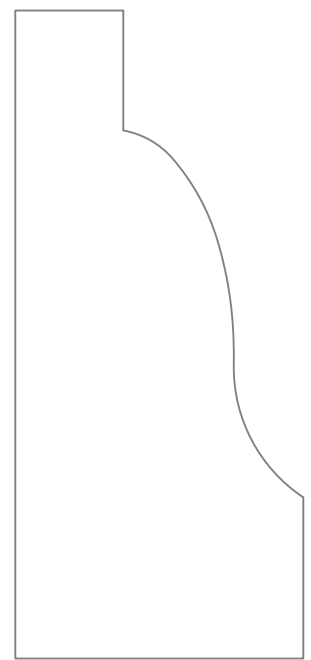

*PM-7510*

*PIERCE & PIERCE MILLWORK*

*FULL SCALE*

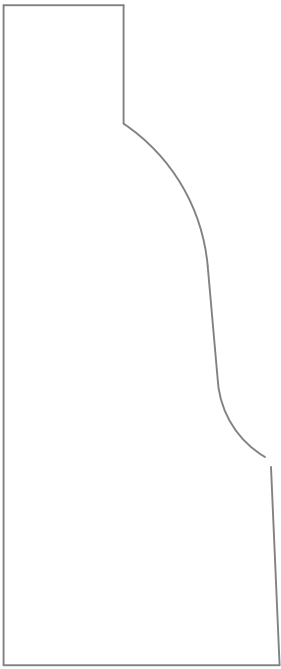

*PM-7511*

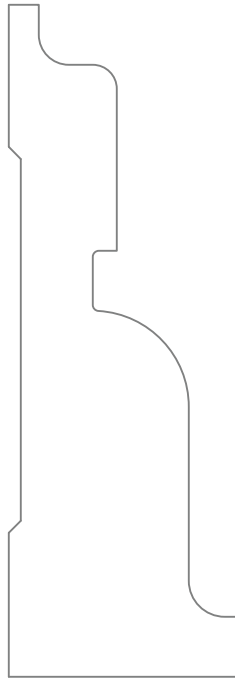

*PM-7506*

# PIERCE & PIERCE MILLWORK

FULL SCALE

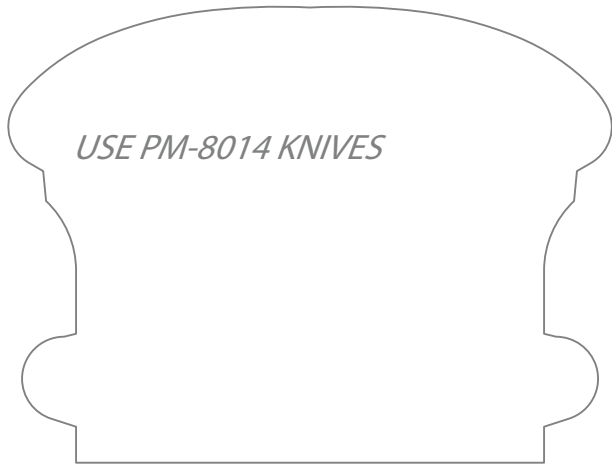

PM-8001

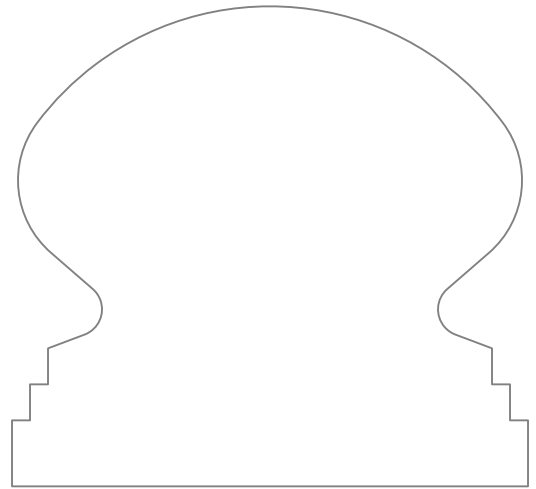

PM-8003

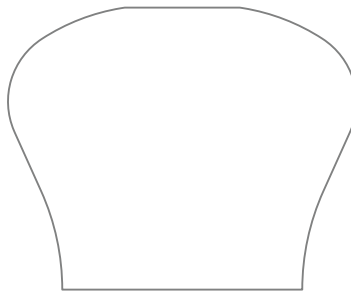

PM-8002

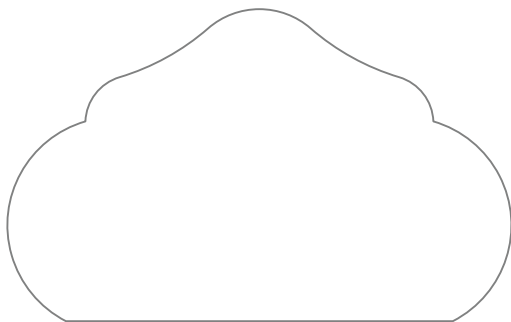

PM-8004

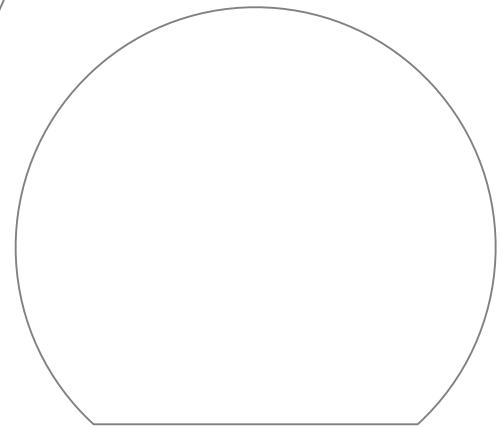

PM-8006

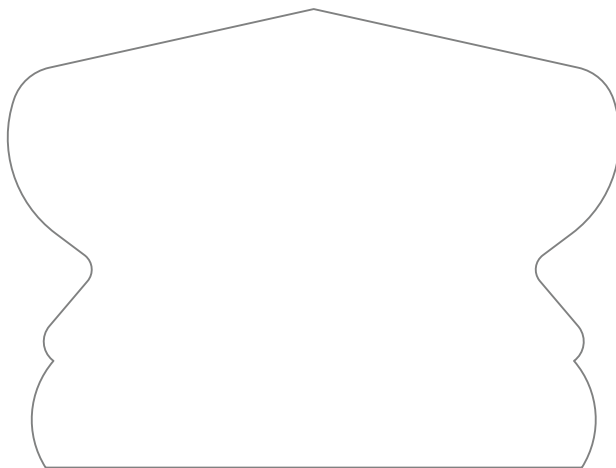

PM-8007

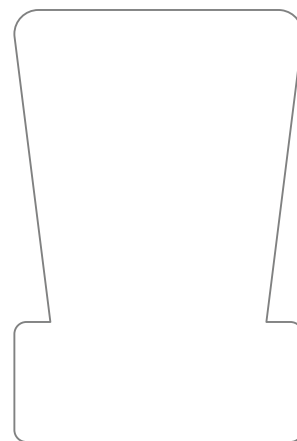

PM-8079

*PIERCE & PIERCE MILLWORK*

*FULL SCALE*

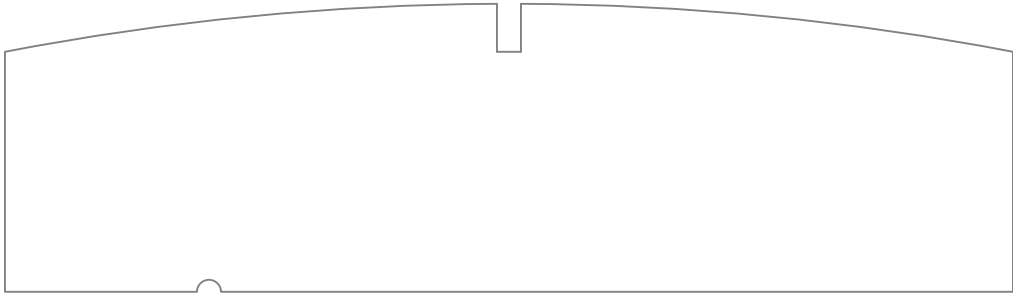

*PM-8094*

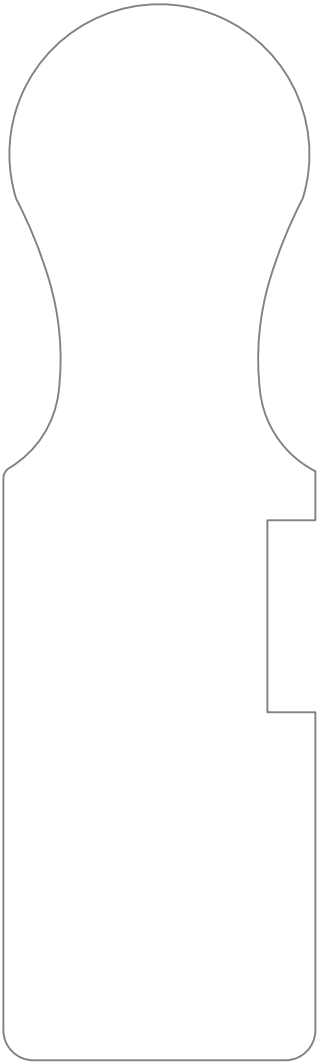

*PM-8005*

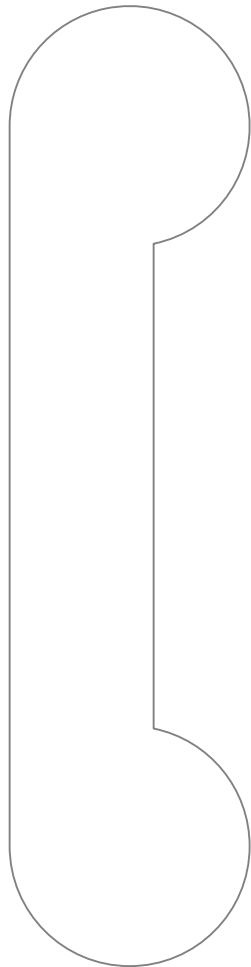

*PM-8061*

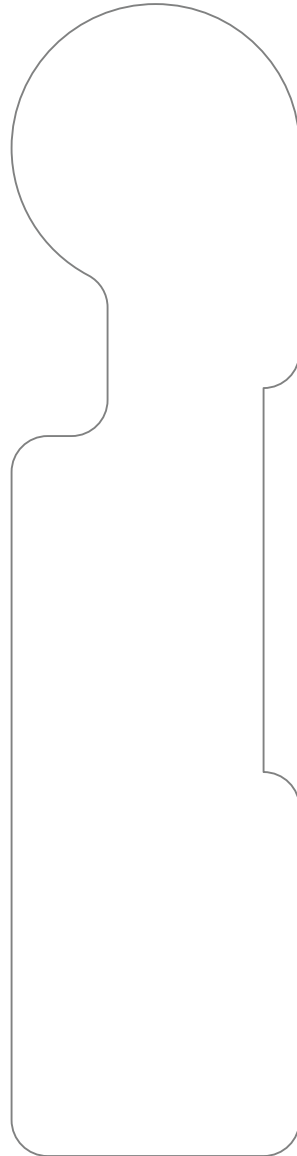

*PM-8062*

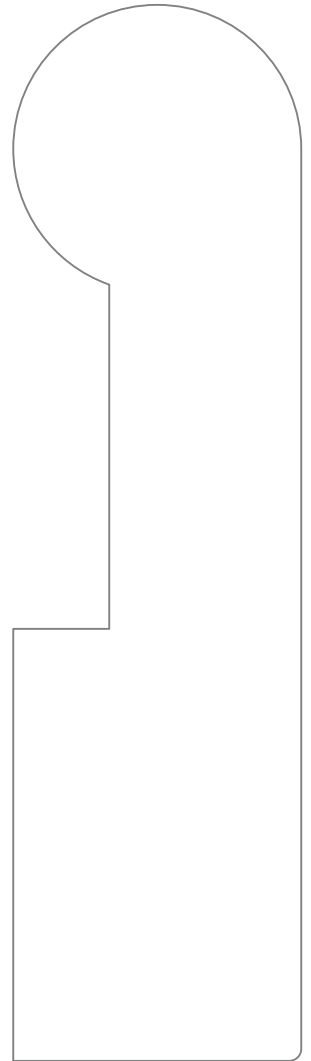

*PM-8063*

*PIERCE & PIERCE MILLWORK*

*FULL SCALE*

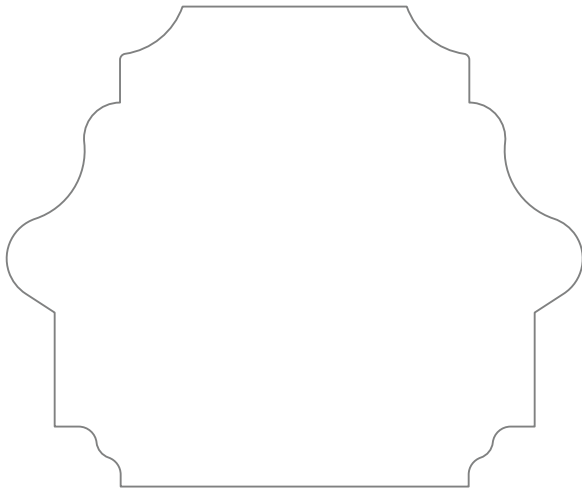

*PM-8008*

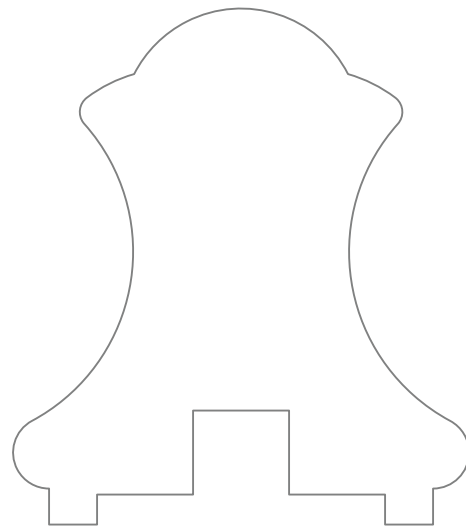

*PM-8047*

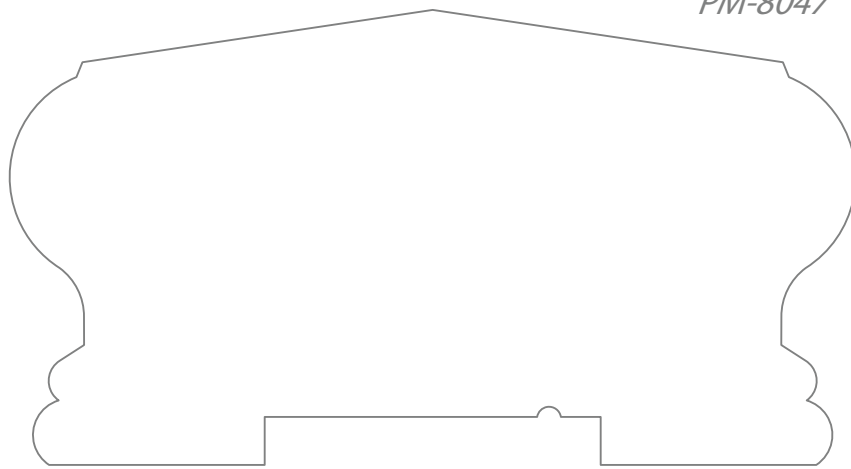

*PM-8051*

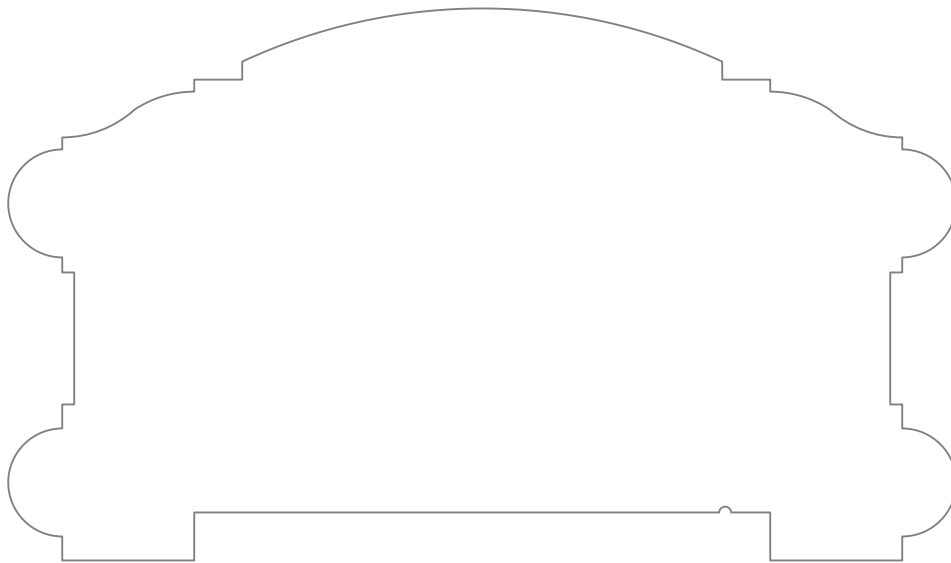

*PM-8049*



*PIERCE & PIERCE MILLWORK*

*FULL SCALE*

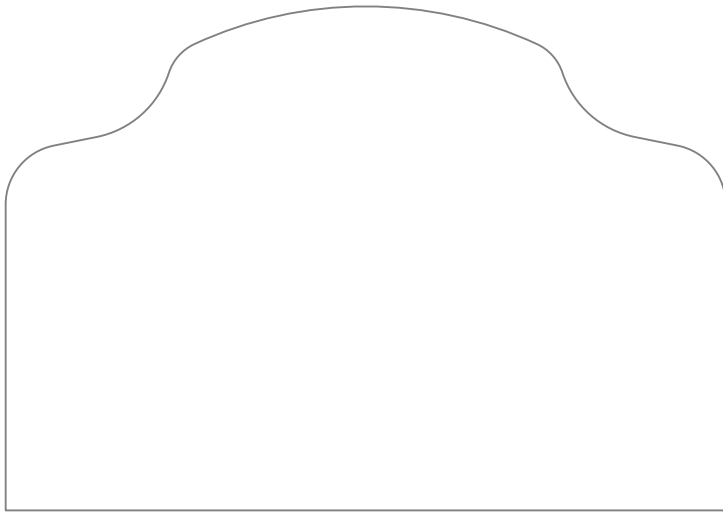

*PM-8057*

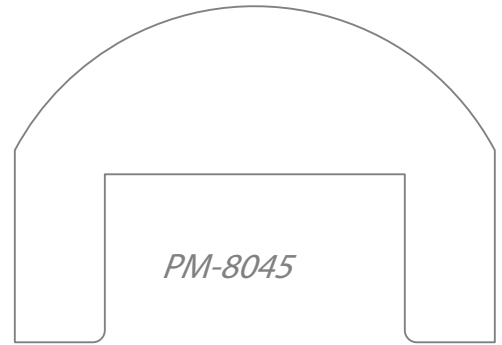

*PM-8045*

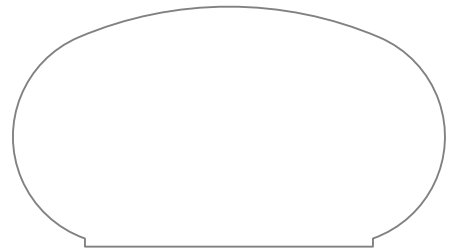

*PM-8067*

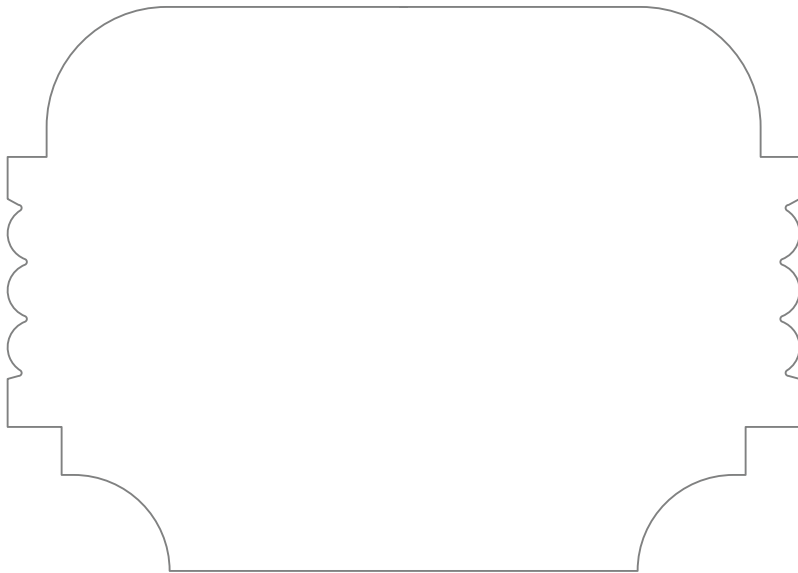

*PM-8065*

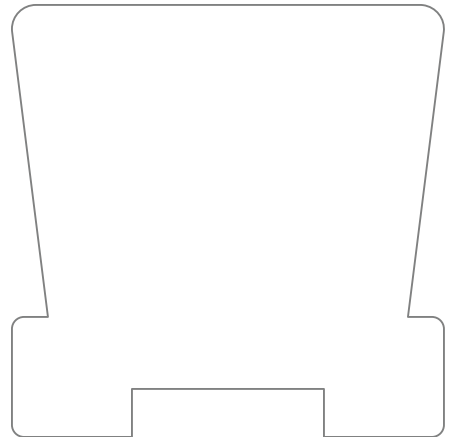

*PM-8091*

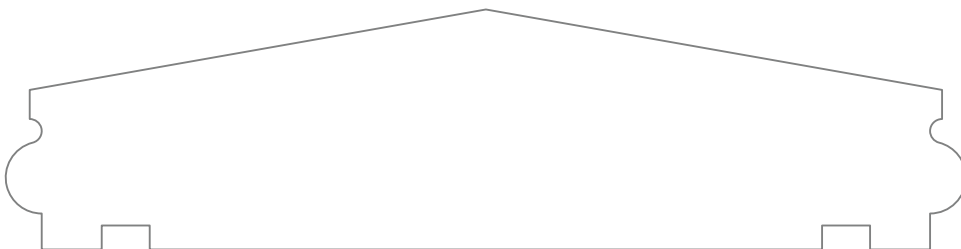

*PM-8025*

*PIERCE & PIERCE MILLWORK*

*FULL SCALE*

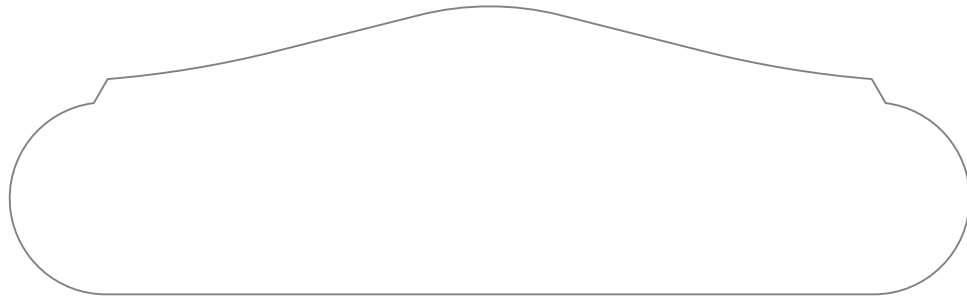

*PM-8013*

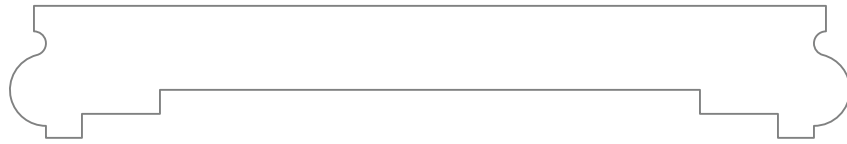

*PM-8013 S/R*



*PM-8082*



*PM-8044*

*PIERCE & PIERCE MILLWORK*

*FULL SCALE*

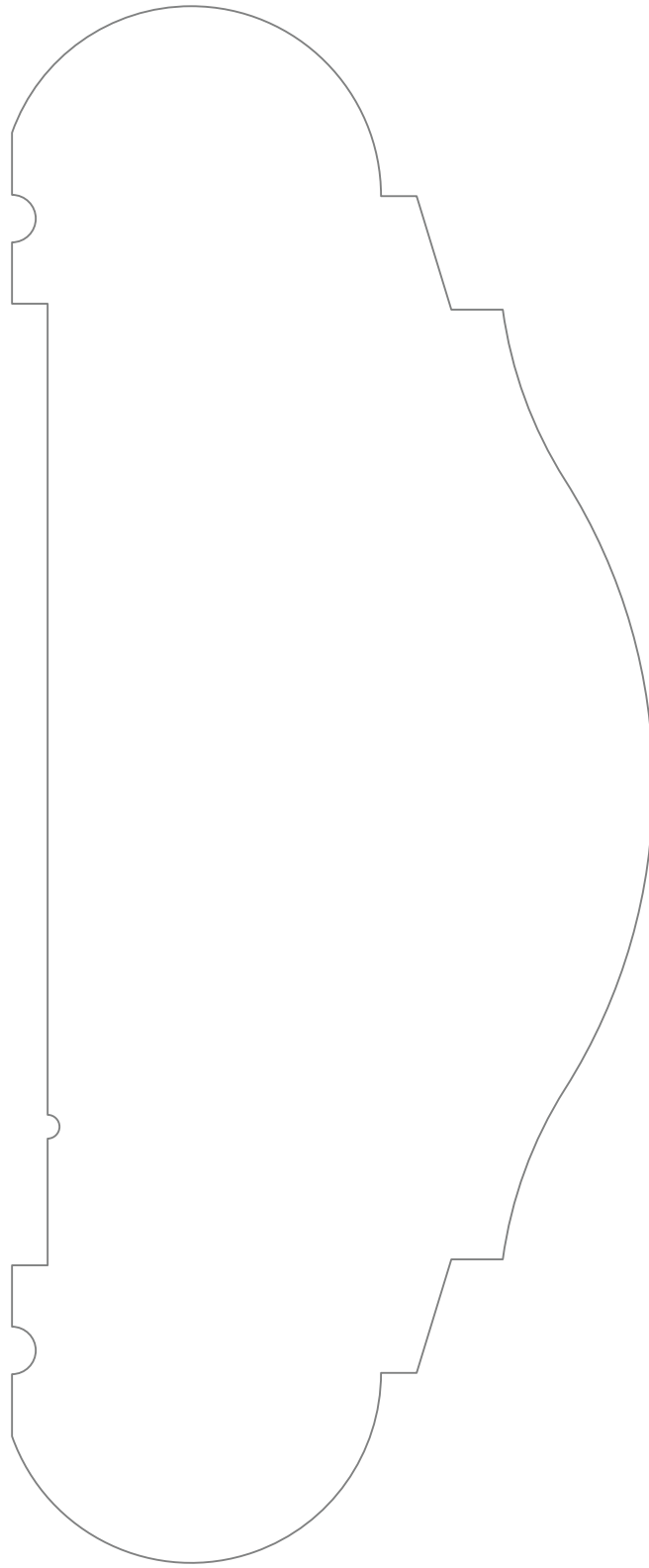

*PM-8036*

*PIERCE & PIERCE MILLWORK*

*FULL SCALE*

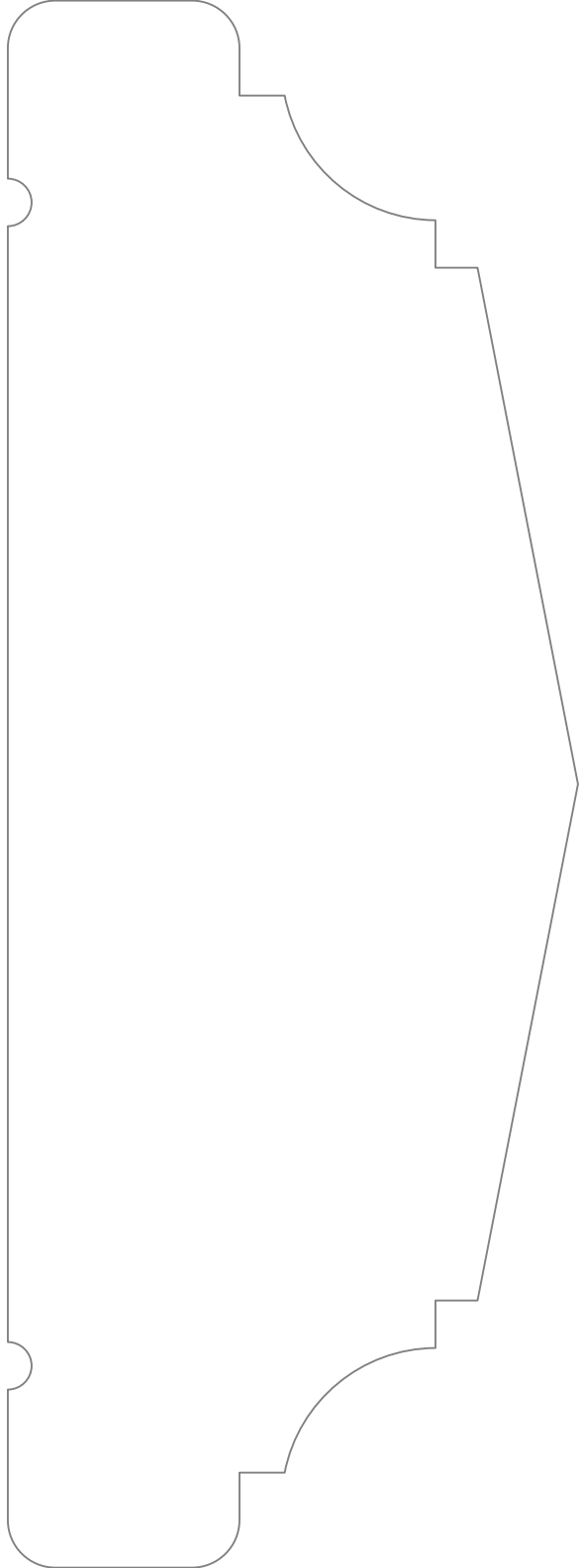

*PM-8037*

*PIERCE & PIERCE MILLWORK*

*FULL SCALE*

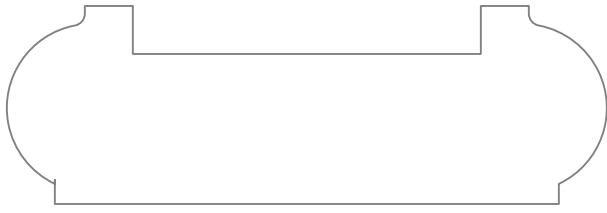

*PM-8017*

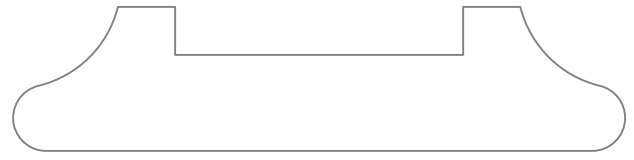

*PM-8018*

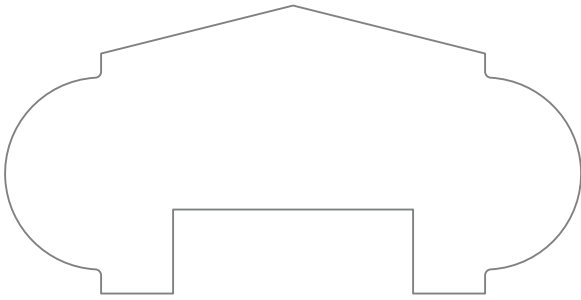

*PM-8046*

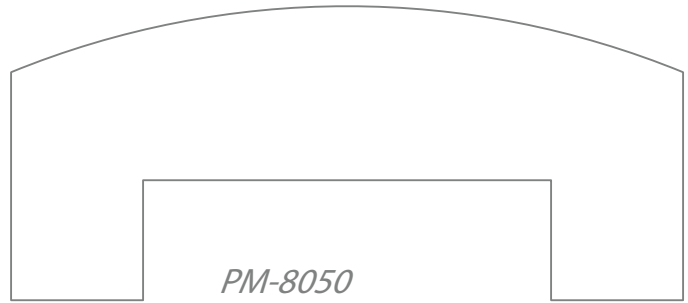

*PM-8050*

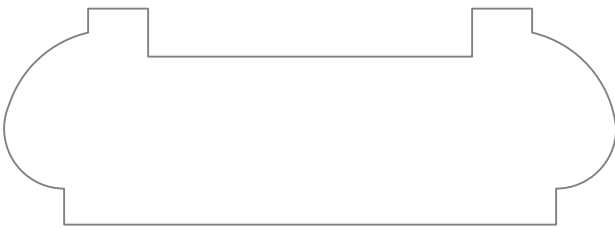

*PM-8068*

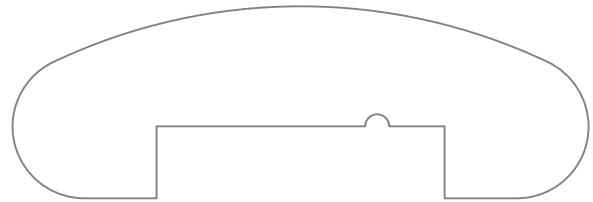

*PM-8080*

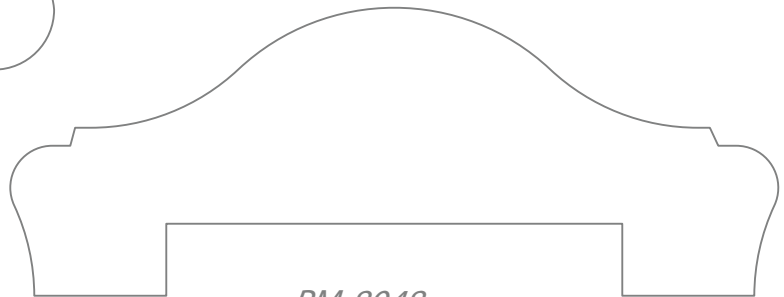

*PM-8048*



*PM-8052*

# PIERCE & PIERCE MILLWORK

FULL SCALE

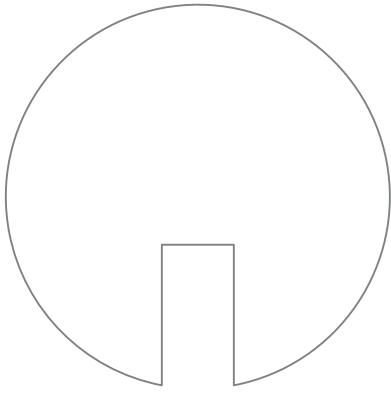

PM-8060

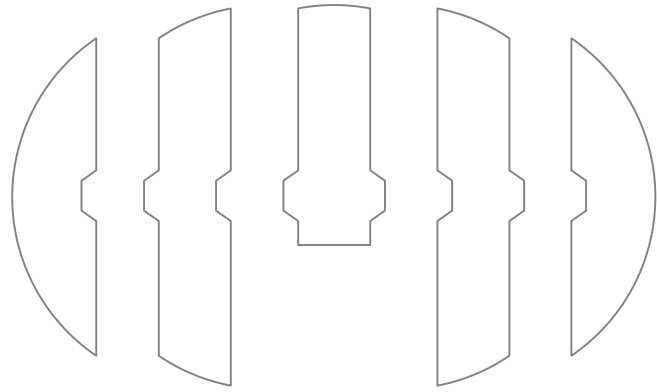

PM-8060-B

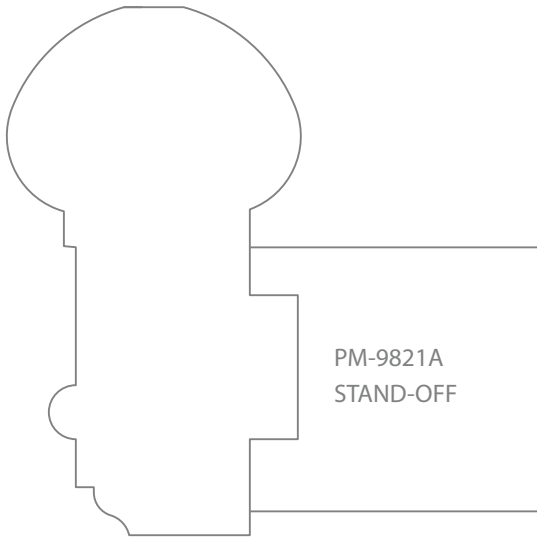

PM-8092

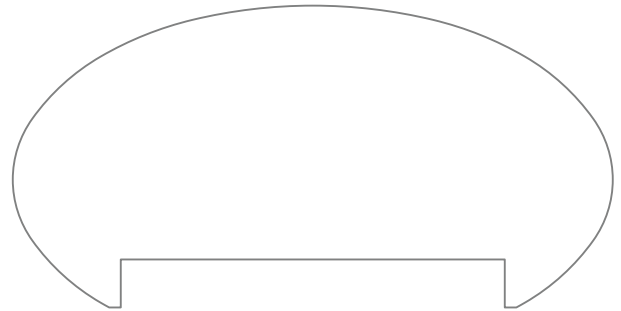

PM-8069

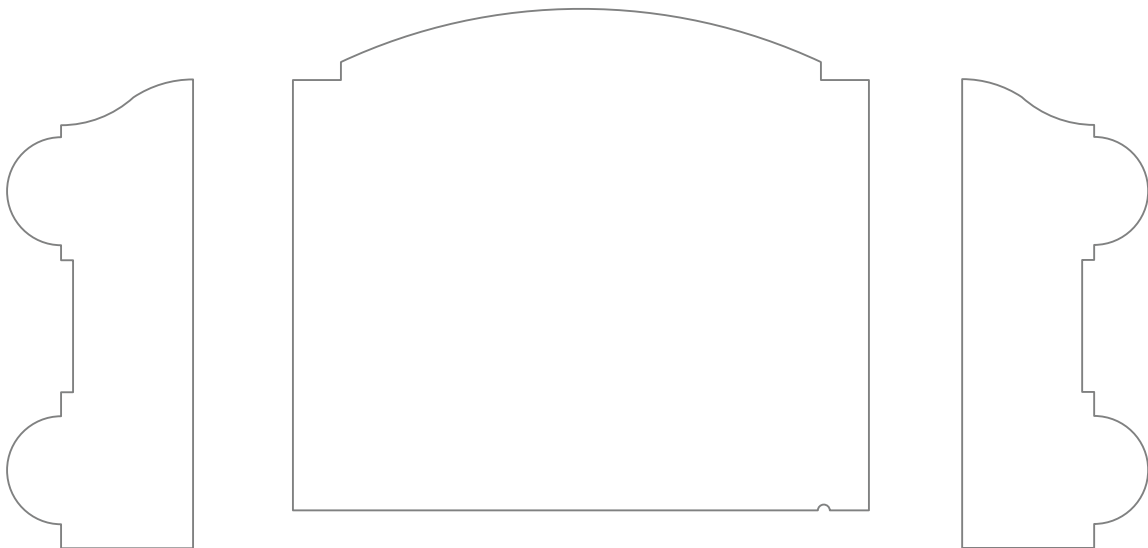

PM-8049 R

*PIERCE & PIERCE MILLWORK*

*FULL SCALE*

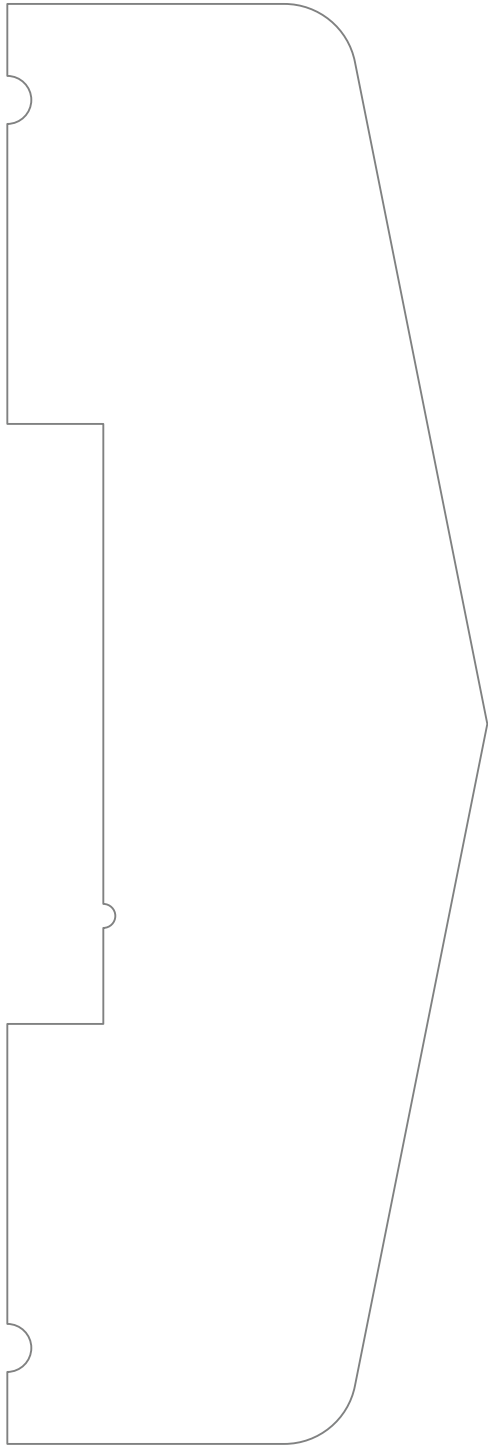

*PM-8059*

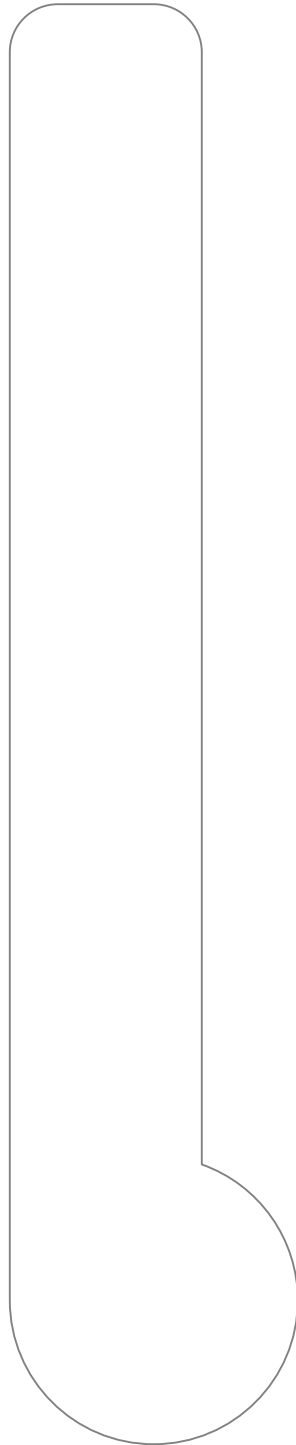

*PM-8059*

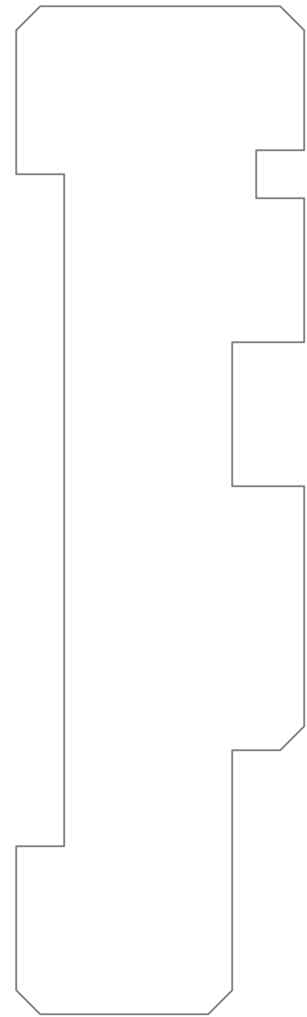

*PM-8078*

*PIERCE & PIERCE MILLWORK*

*FULL SCALE*

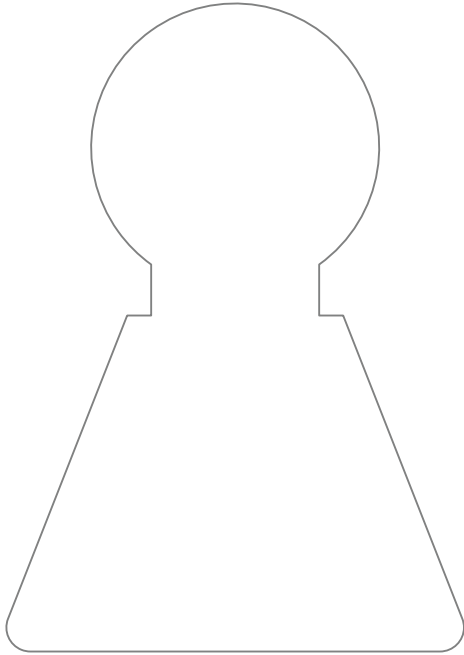

*PM-8056*

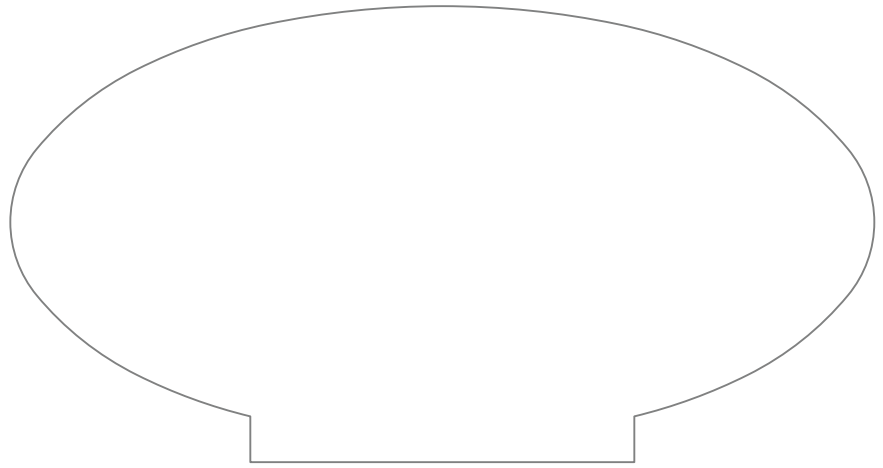

*PM-8063 B*

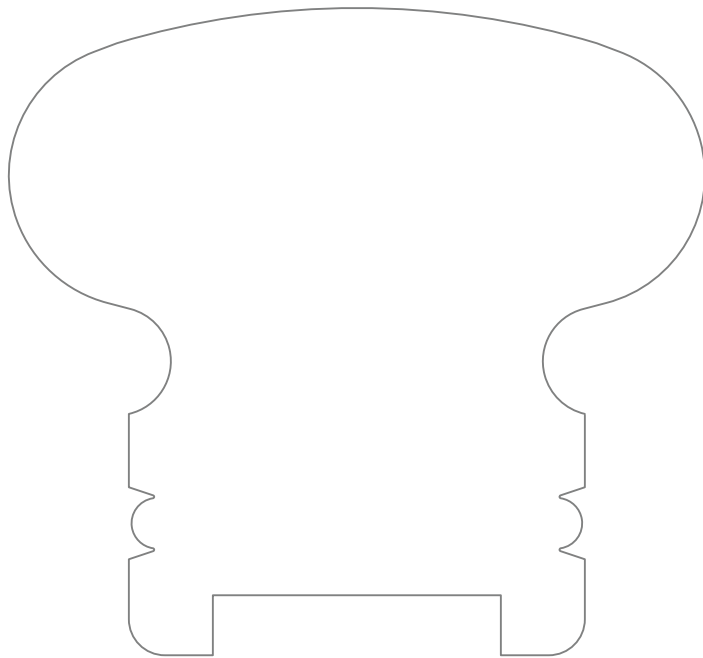

*PM-8076*

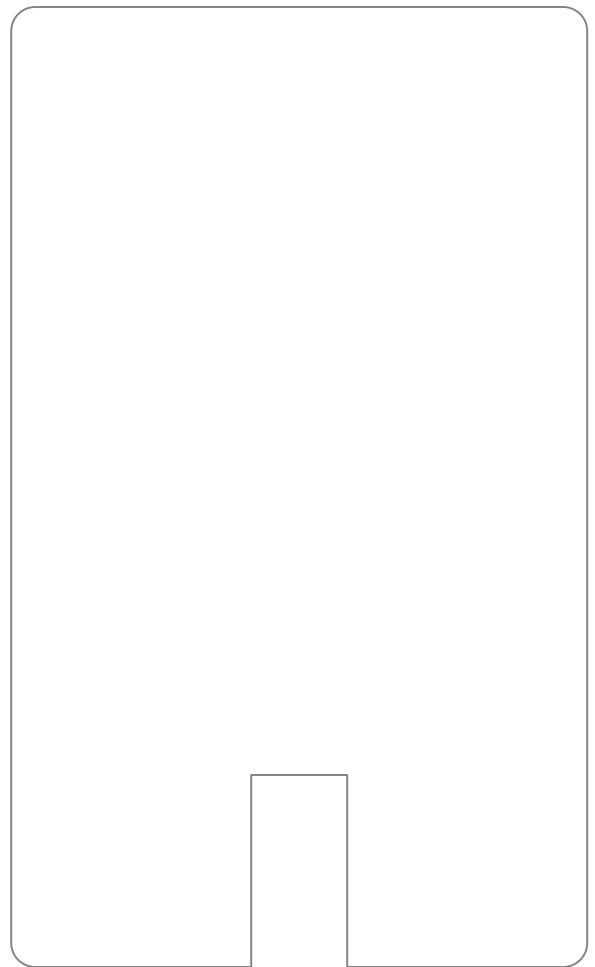

*PM-8066*



*PIERCE & PIERCE MILLWORK*

*FULL SCALE*

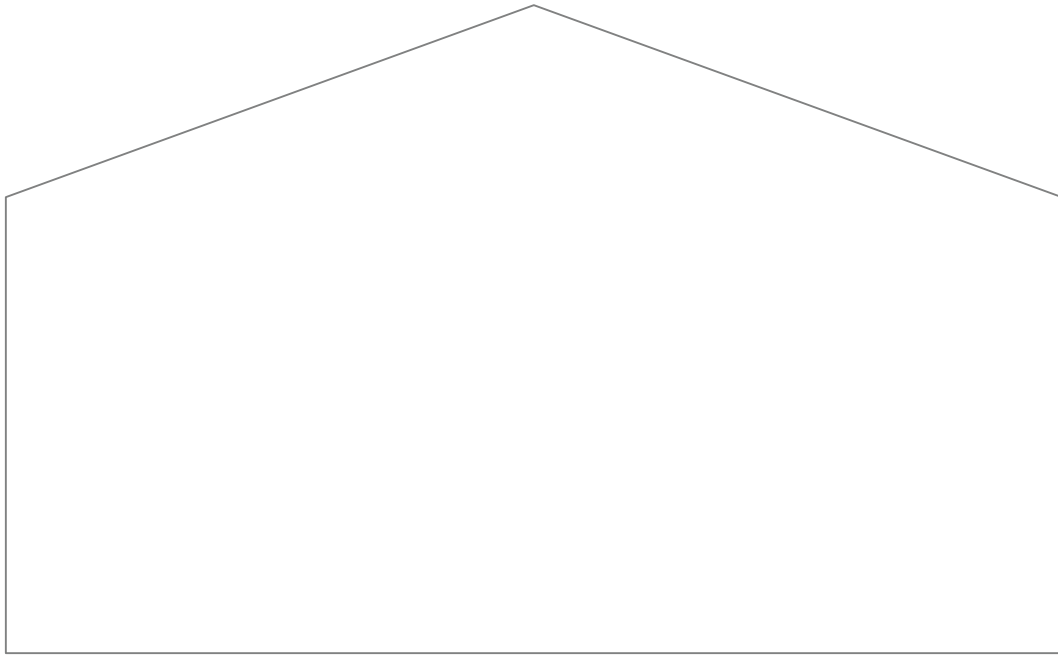

*PM-8081*



*PM-8084*

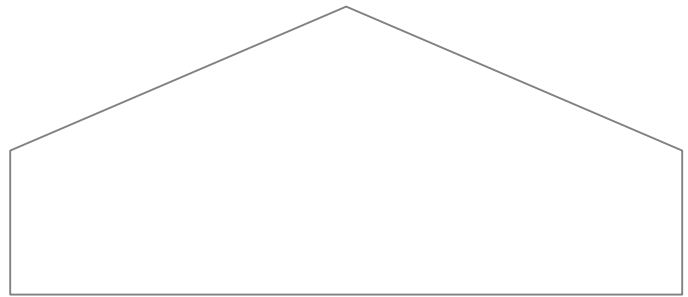

*PM-8083*

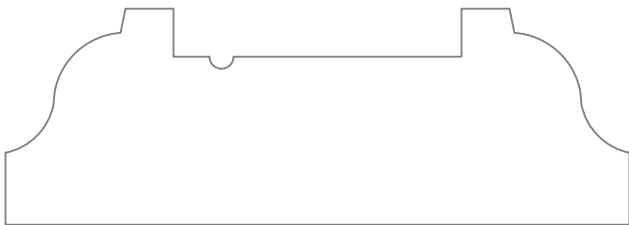

*PM-8077*

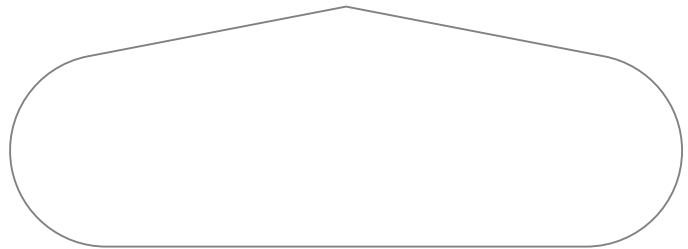

*PM-8089*

*PIERCE & PIERCE MILLWORK*

*FULL SCALE*

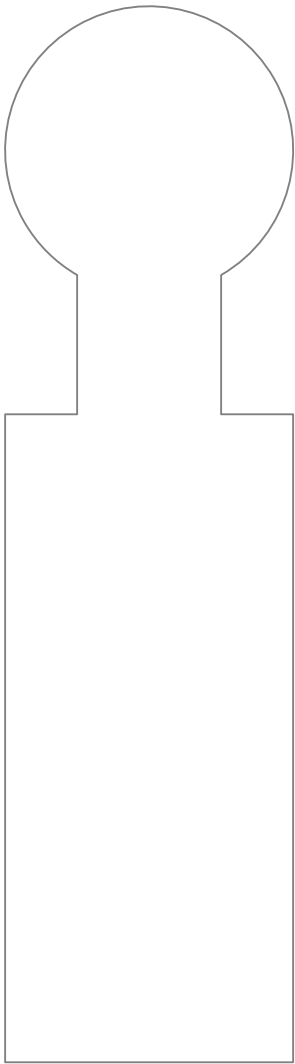

*PM-8075*

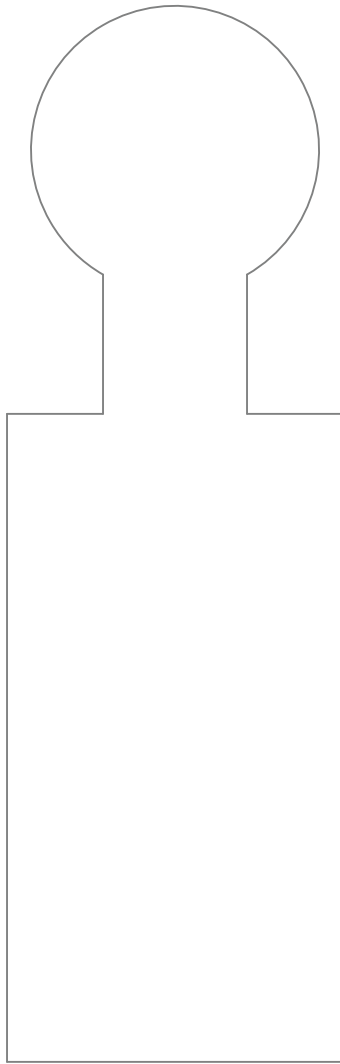

*PM-8085*

LOOK AT PM-8075 KNIVES

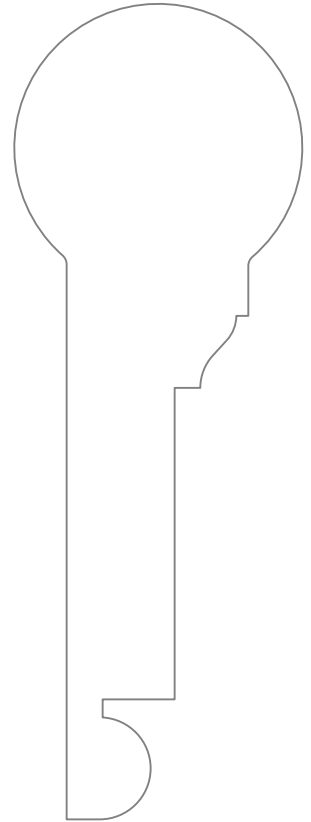

*PM-8070*

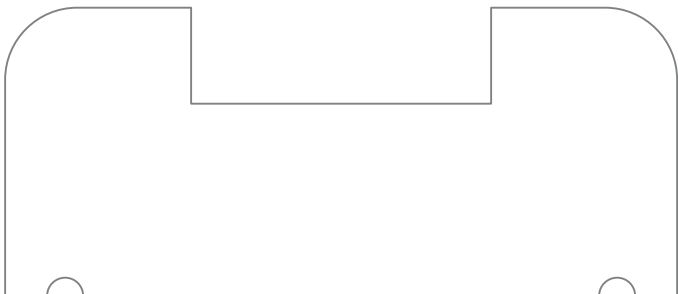

*PM-8072*

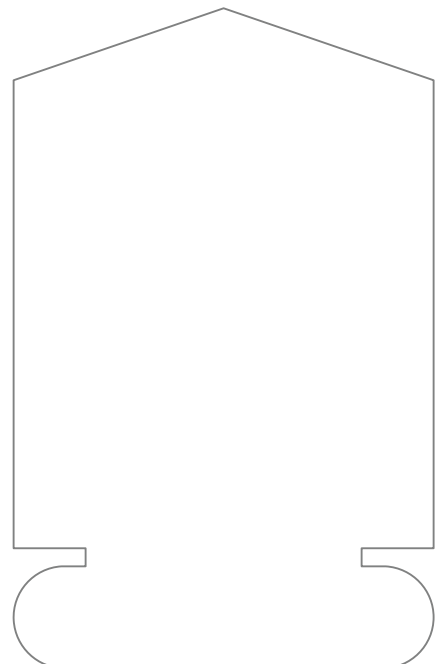

*PM-8087*

*PIERCE & PIERCE MILLWORK*

*FULL SCALE*

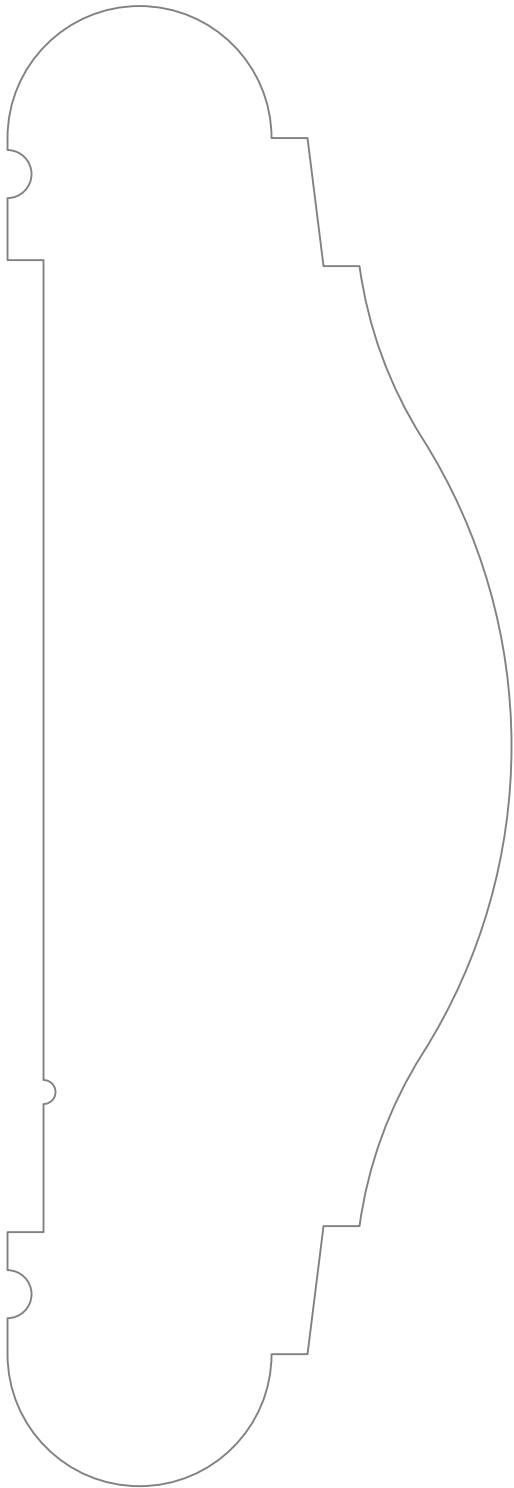

*PM-8073*

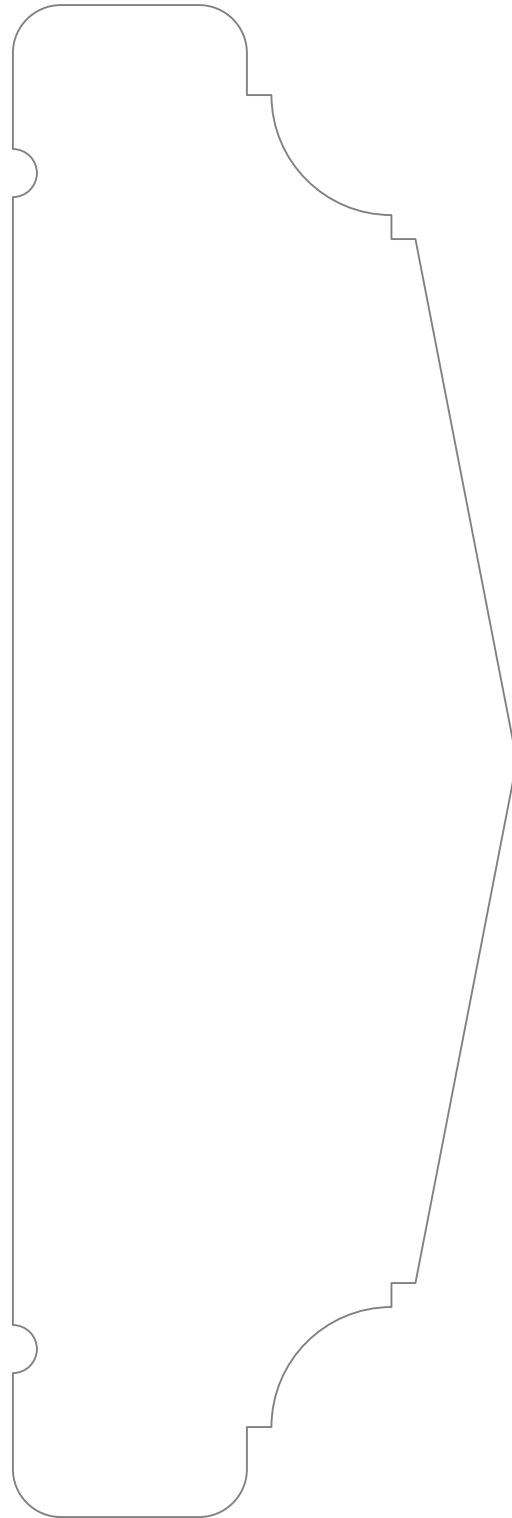

*PM-8074*

*PIERCE & PIERCE MILLWORK*

*FULL SCALE*

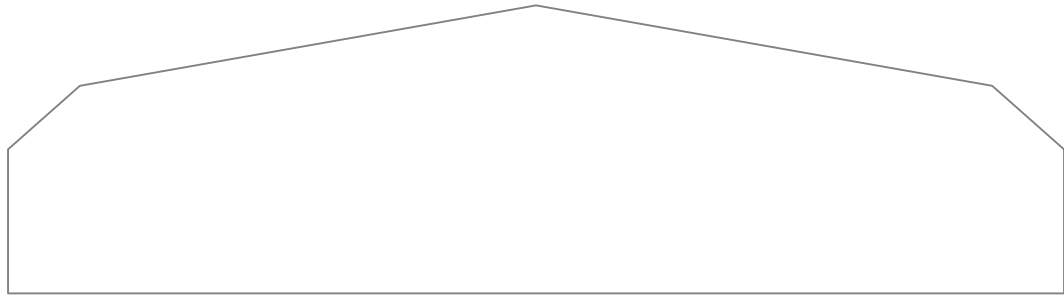

*PM-8086*

*USE PM-8013 TOP KNIVES*

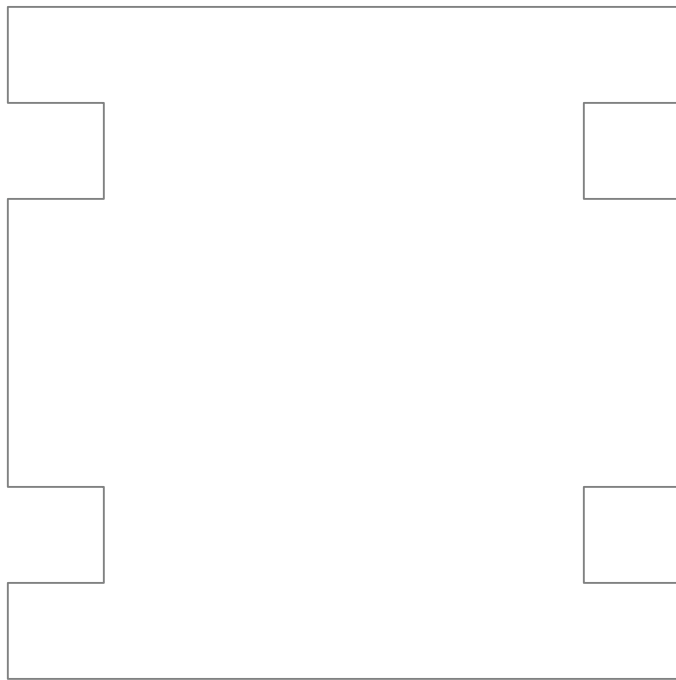

*PM-8093*

*PIERCE & PIERCE MILLWORK*

*FULL SCALE*

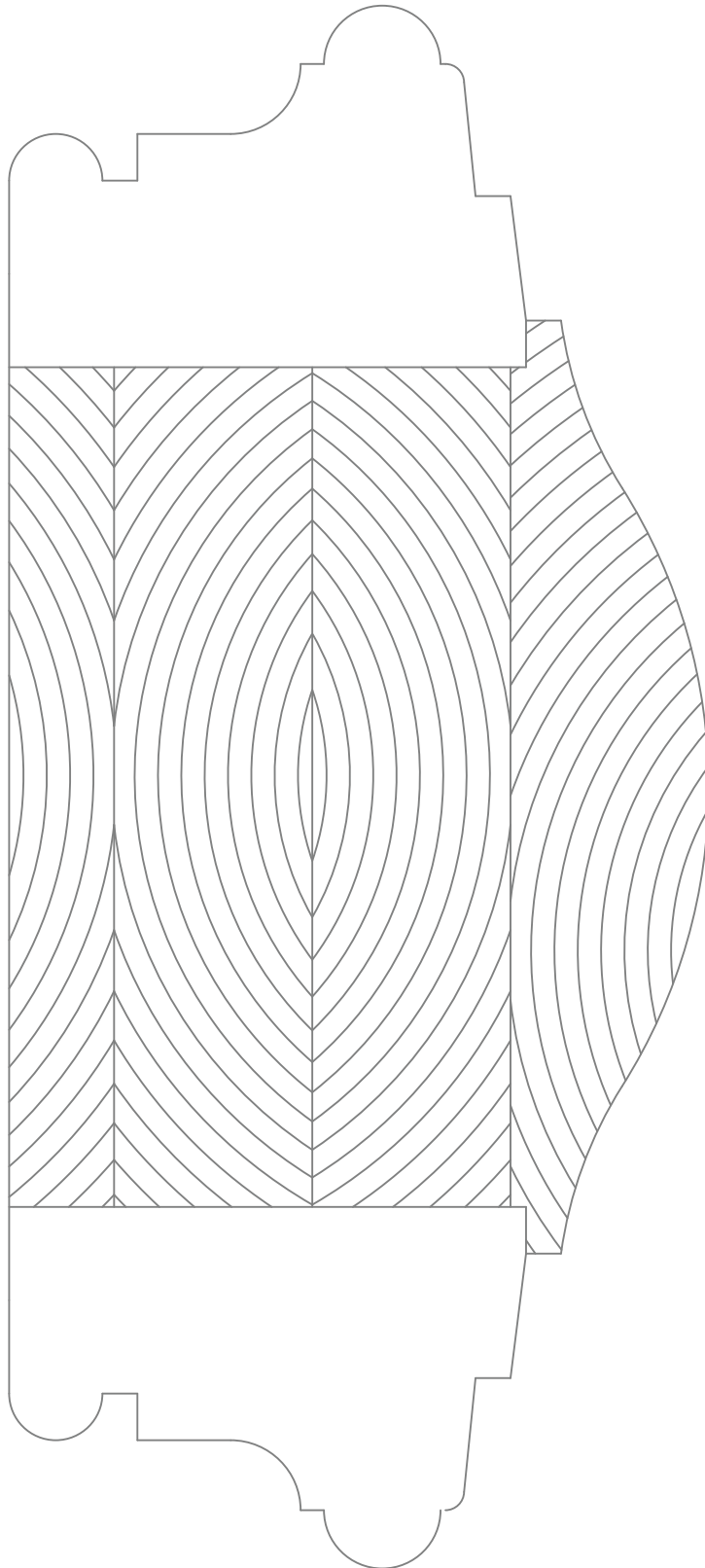

*PM-8090*

*PIERCE & PIERCE MILLWORK*

*FULL SCALE*

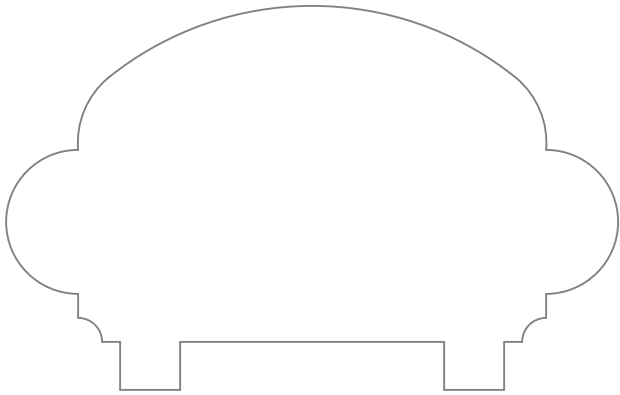

*PM-8099*

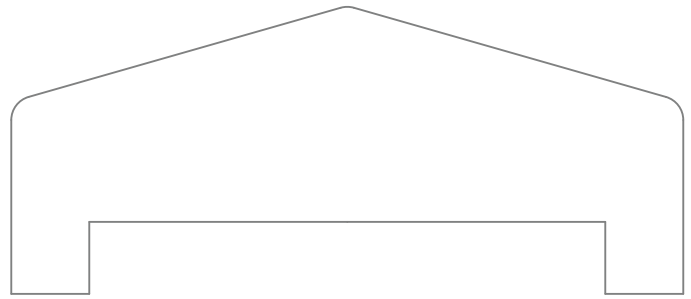

*PM-8096*

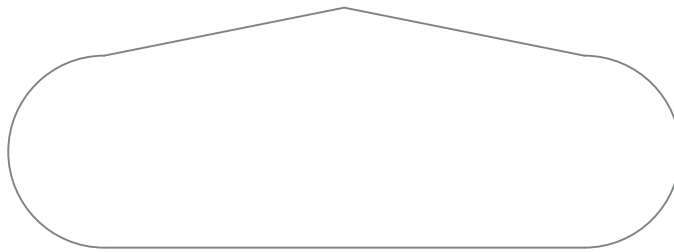

*PM-8009*

*USE CUSTOM SHOE RAIL*

*AS PER FAX*

*PIERCE & PIERCE MILLWORK*

*FULL SCALE*

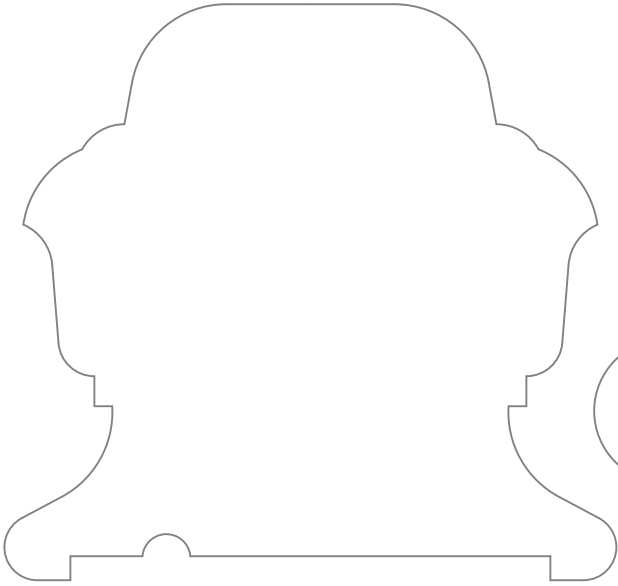

*PM-8101*

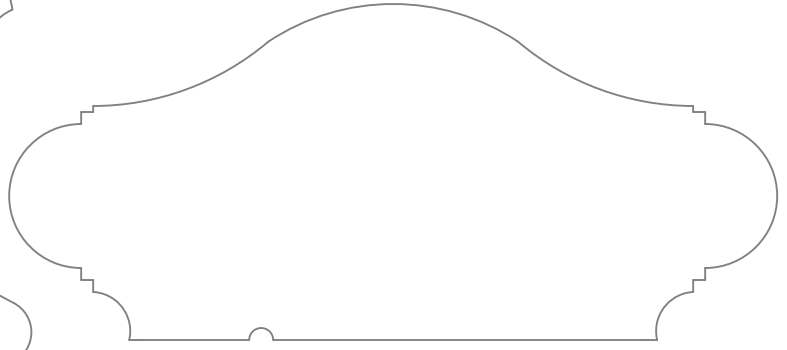

*PM-8136*

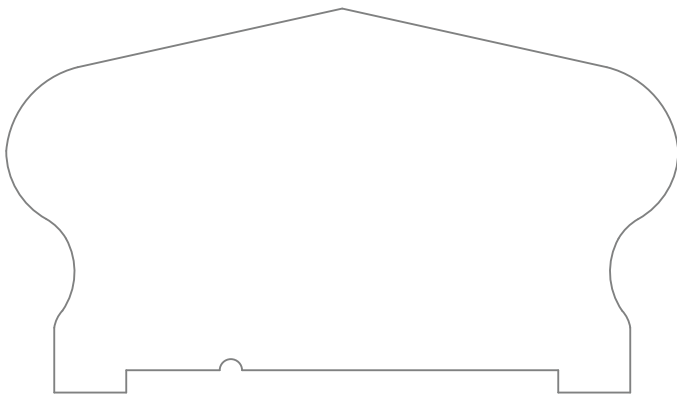

*PM-8134*

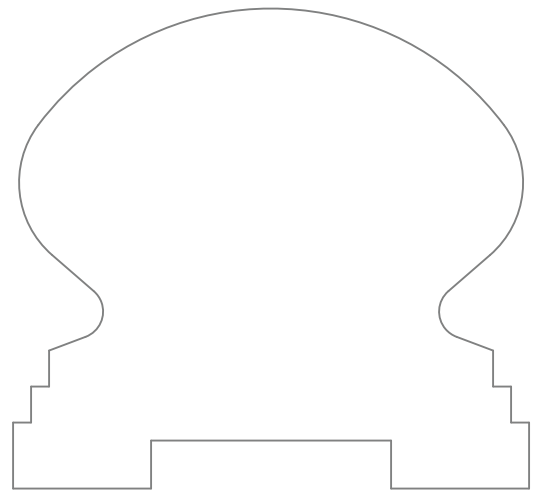

*PM-8116*

*PIERCE & PIERCE MILLWORK*

*FULL SCALE*

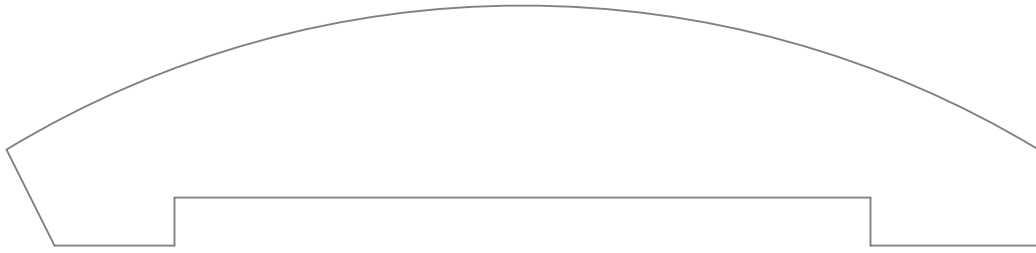

*PM-8120*

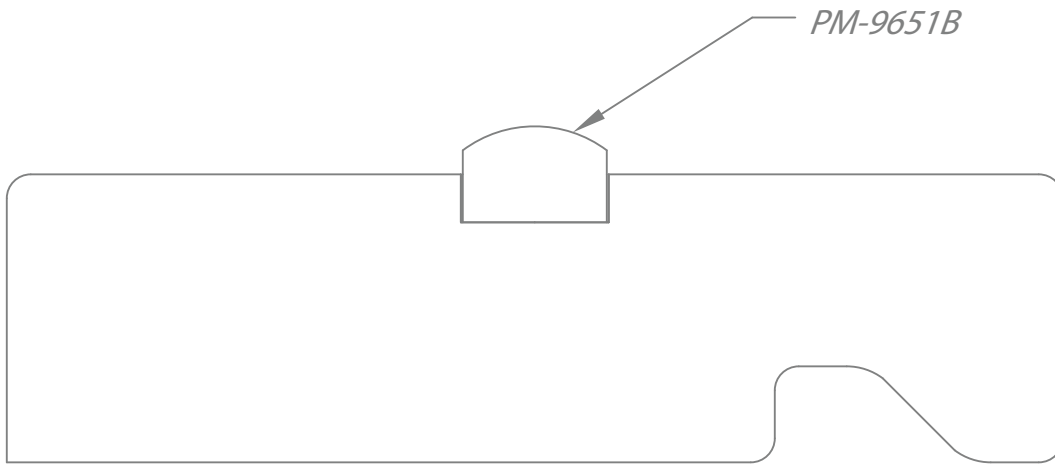

*PM-8129*

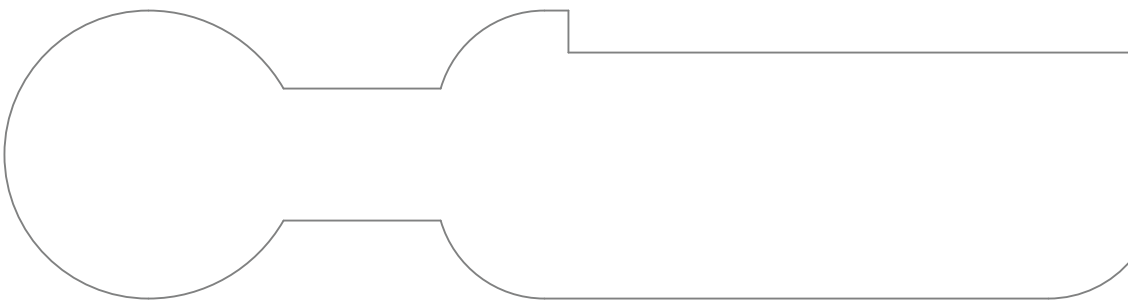

*PM-8130*



*PIERCE & PIERCE MILLWORK*

*FULL SCALE*

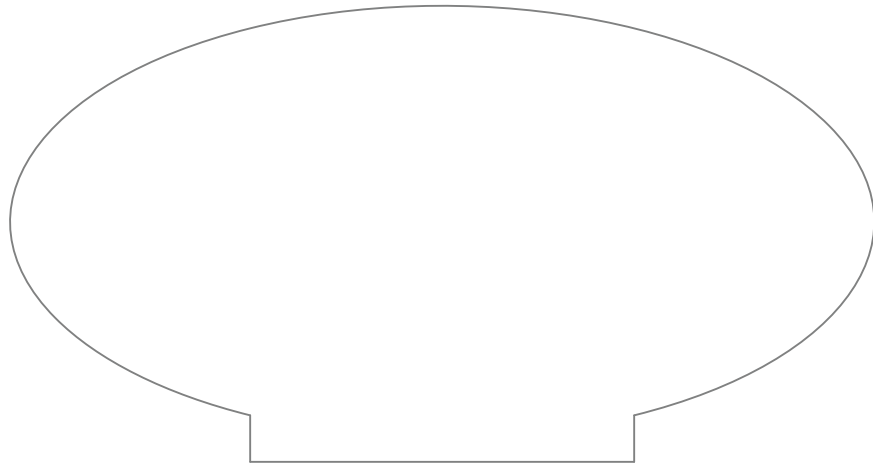

*PM-8202*

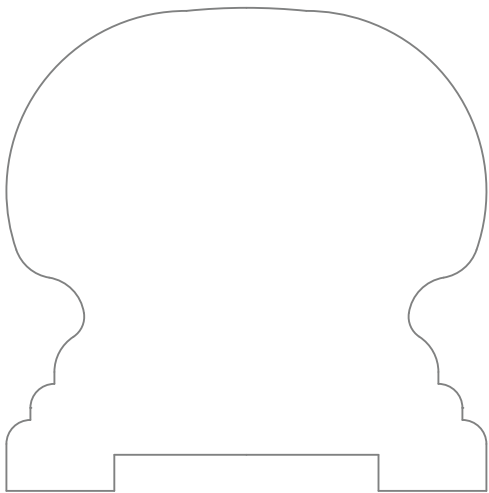

*PM-8204*

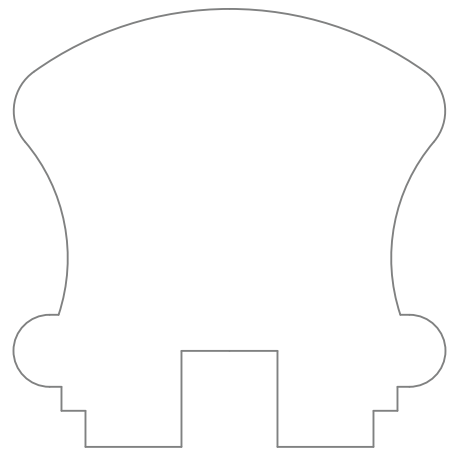

*PM-8207*

*PIERCE & PIERCE MILLWORK*

*FULL SCALE*

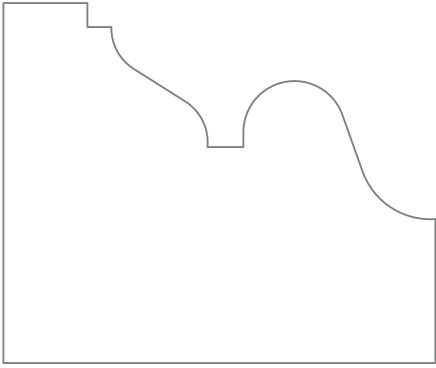

*PM-8502*

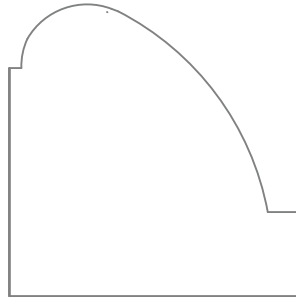

*PM-8509*

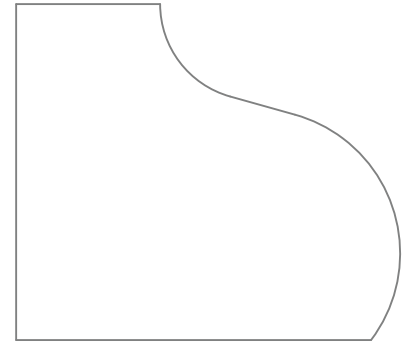

*PM-8510*

# PIERCE & PIERCE MILLWORK

FULL SCALE

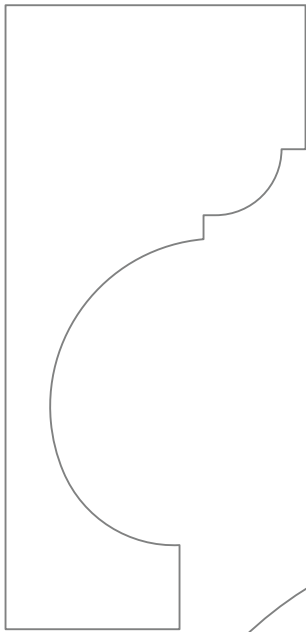

PM-9501



PM-9502

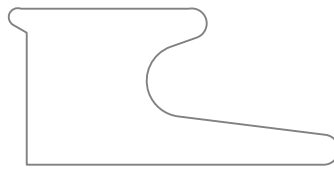

PM-9504

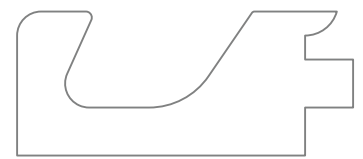

PM-9507

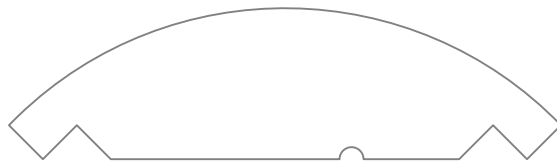

PM-9541

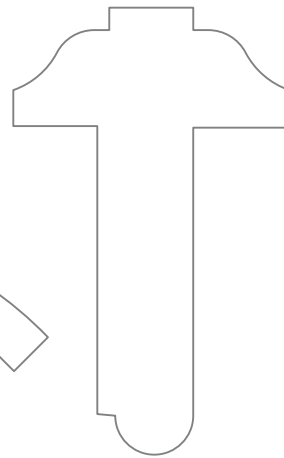

PM-9512

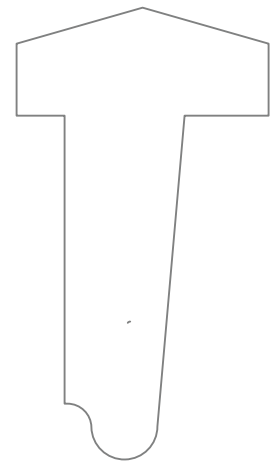

PM-9513



PM-9531



5/16"

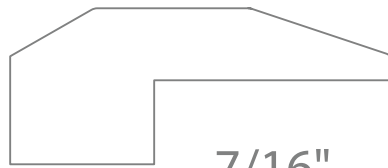

7/16"

PM-9563



PM-9530

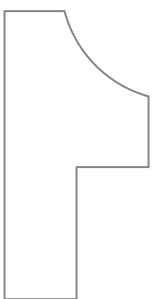

PM-9523



PM-9534



PM-9524

*PIERCE & PIERCE MILLWORK*

*FULL SCALE*

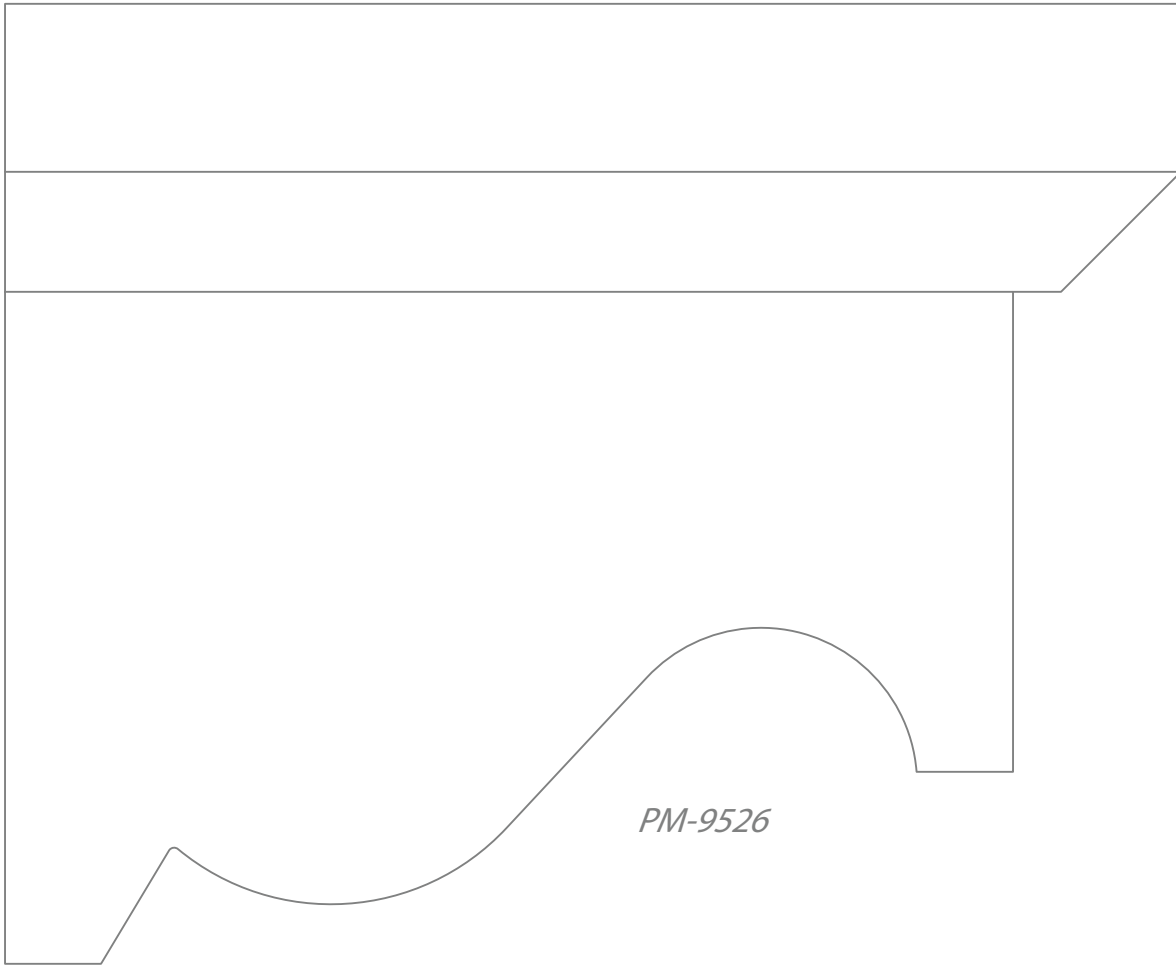

*PM-9526*

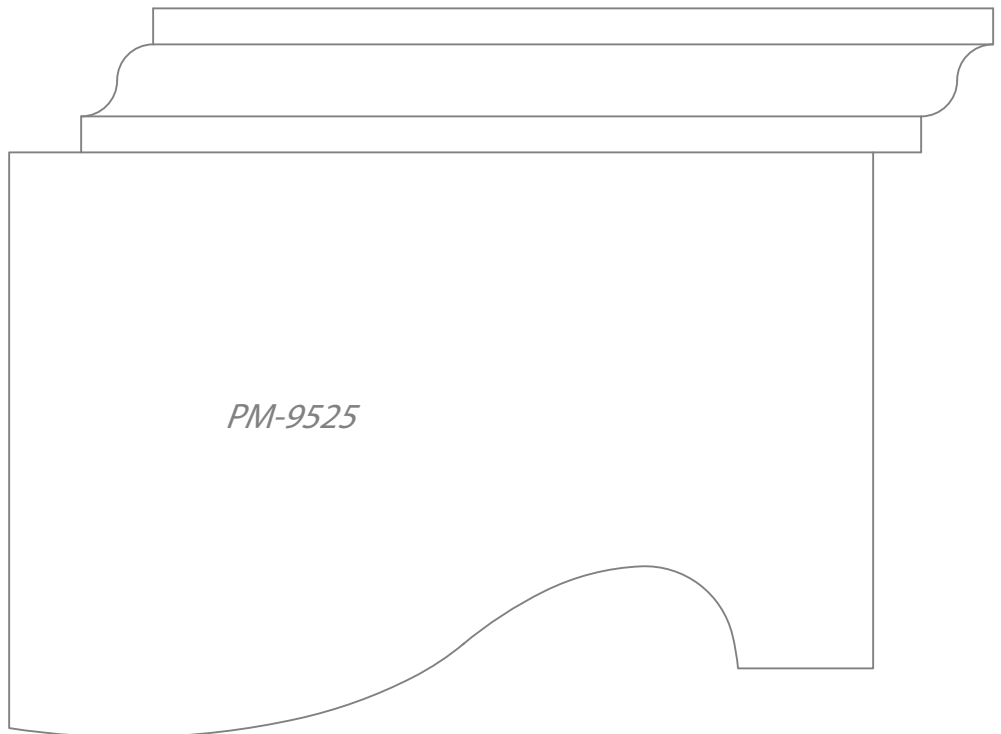

*PM-9525*

*PIERCE & PIERCE MILLWORK*

*FULL SCALE*

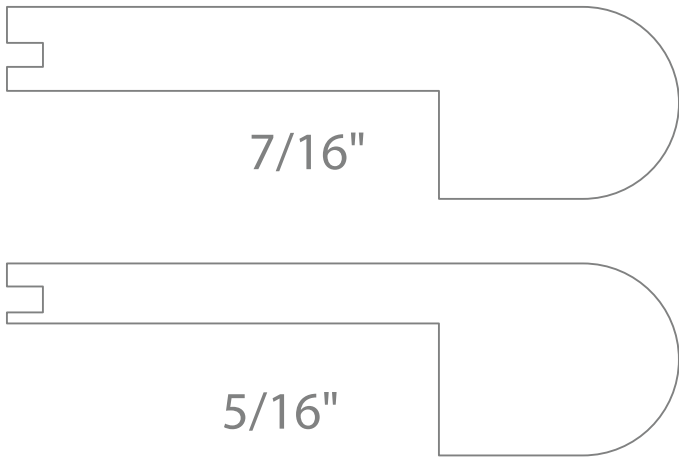

*PM-9564*



*PM-9575*



*PM-9521*

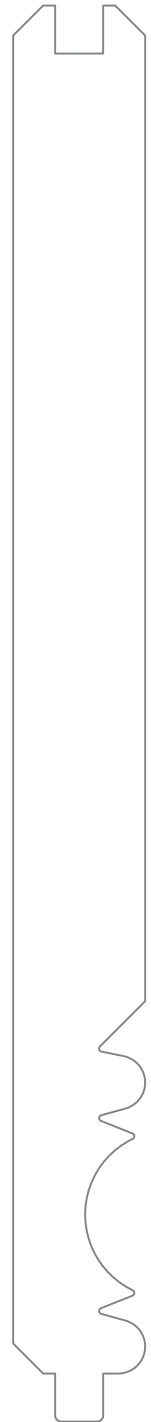

*PM-9520*

# PIERCE & PIERCE MILLWORK

FULL SCALE



PM-9693

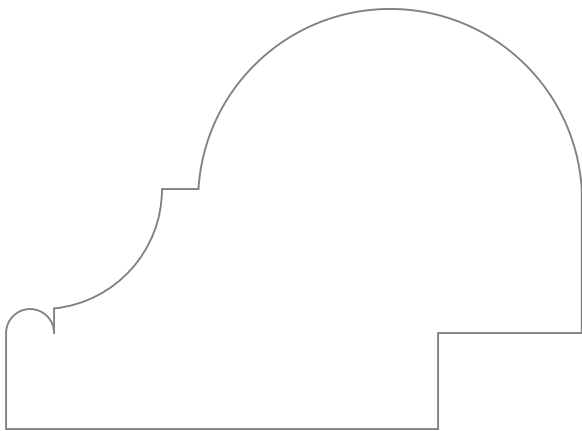

PM-9647

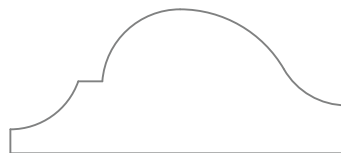

PM-9650



PM-9634

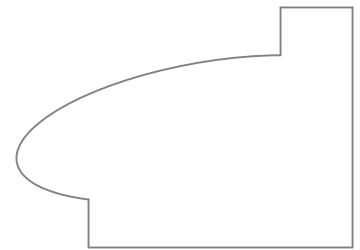

PM-9658



PM-9684



PM-9674



PM-9673

*PIERCE & PIERCE MILLWORK*

*FULL SCALE*

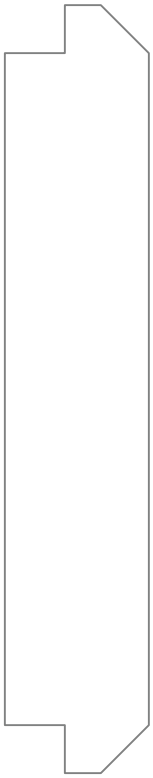

*PM-9700*

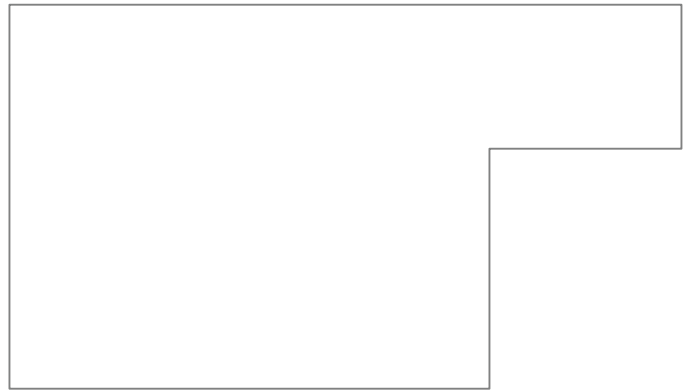

*PM-9717*

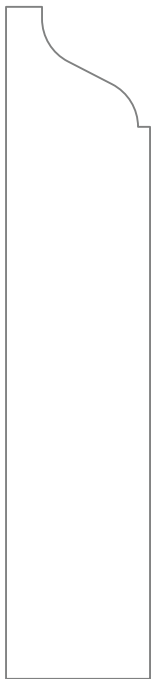

*PM-9708*



*PM-9722*



*PM-9724*



*PM-9716*

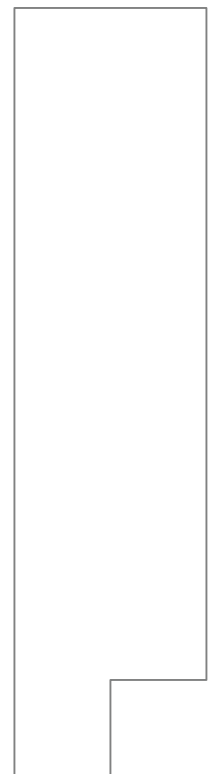

*PM-9723*

# PIERCE & PIERCE MILLWORK

FULL SCALE

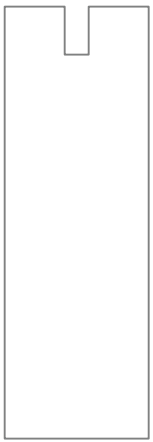

PM-9701



PM-9712



PM-9714



PM-9715

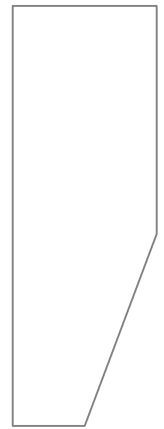

PM-9719

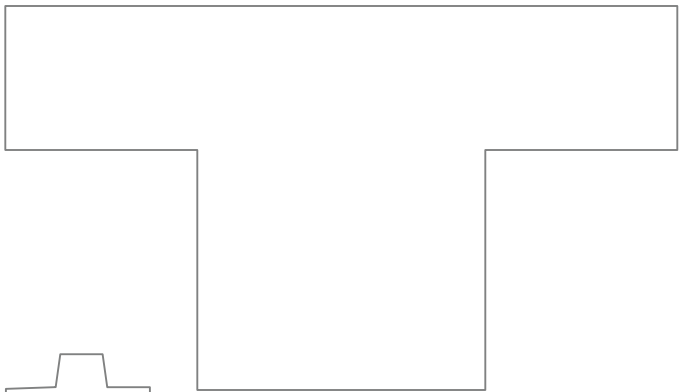

PM-9718

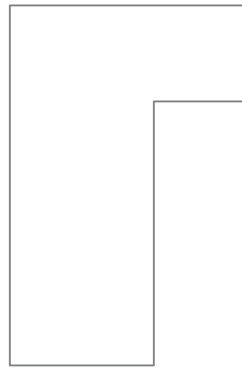

PM-9709

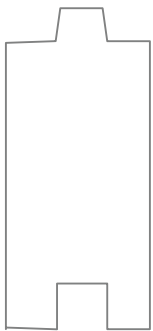

PM-9744

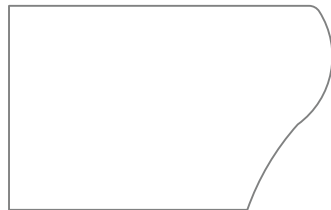

PM-9720



PM-9748

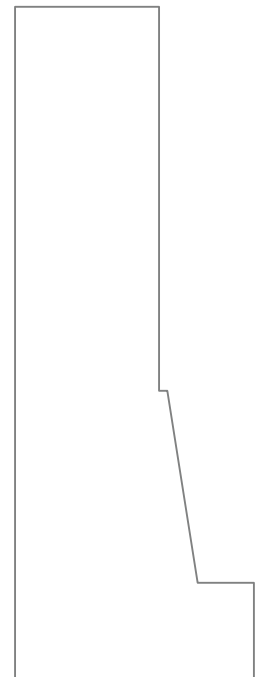

PM-9726

PM-9729

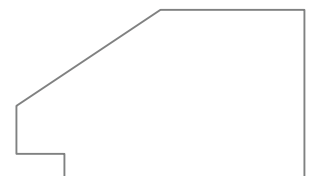

PM-9707



# PIERCE & PIERCE MILLWORK

FULL SCALE

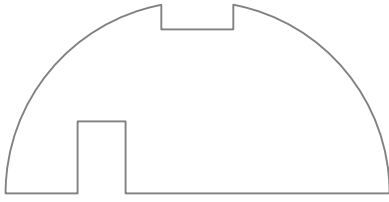

PM-9702

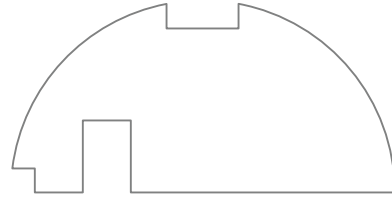

PM-9702 M

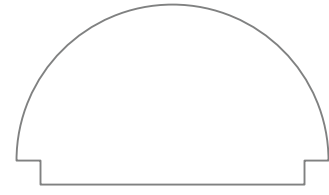

PM-9710

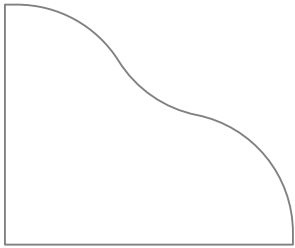

PM-9704

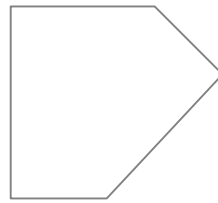

PM-9706

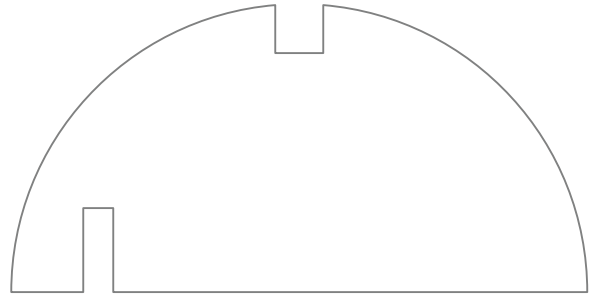

PM-9728

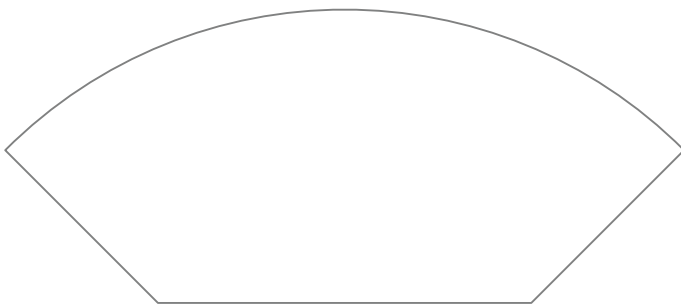

PM-9727

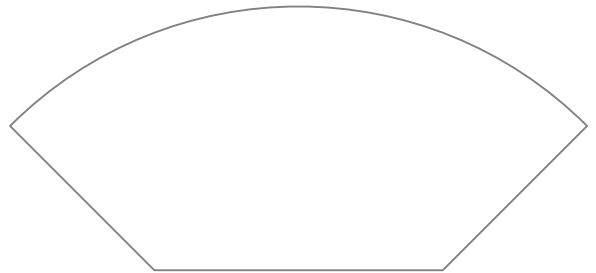

PM-9705

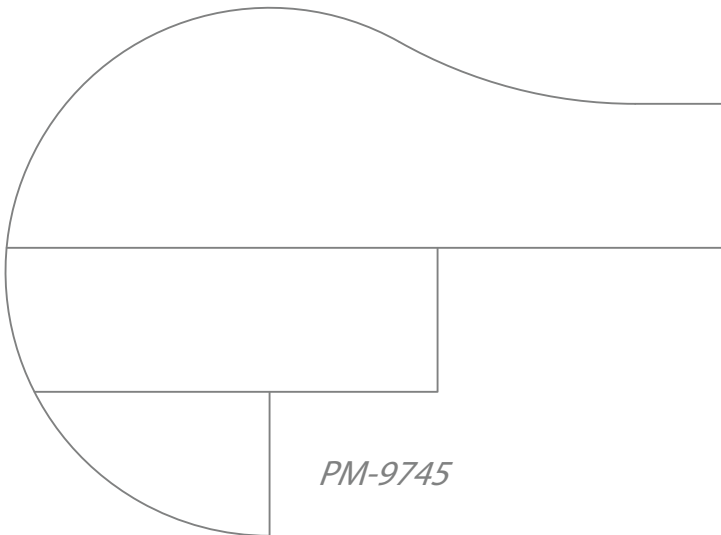

PM-9745

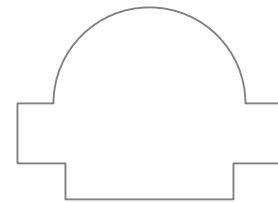

PM-9711



PM-9731

*PIERCE & PIERCE MILLWORK*

*FULL SCALE*

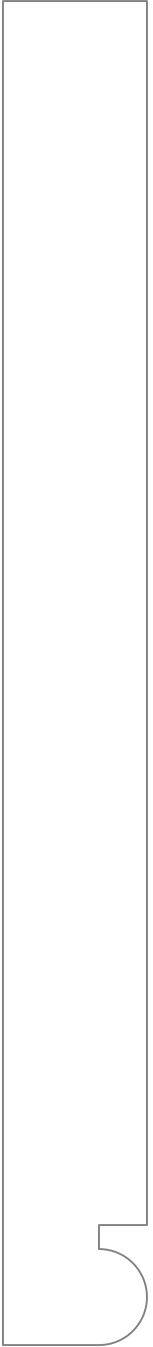

*PM-9730*

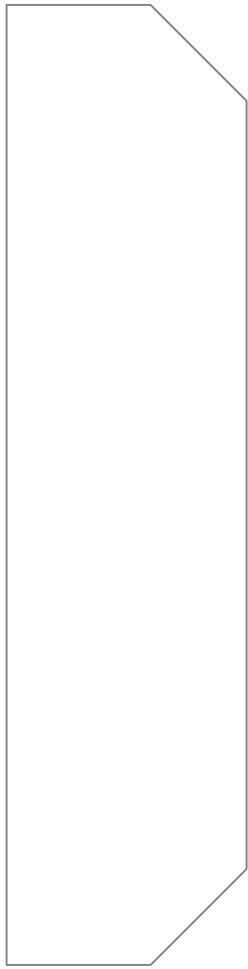

*PM-9703*

# PIERCE & PIERCE MILLWORK

FULL SCALE

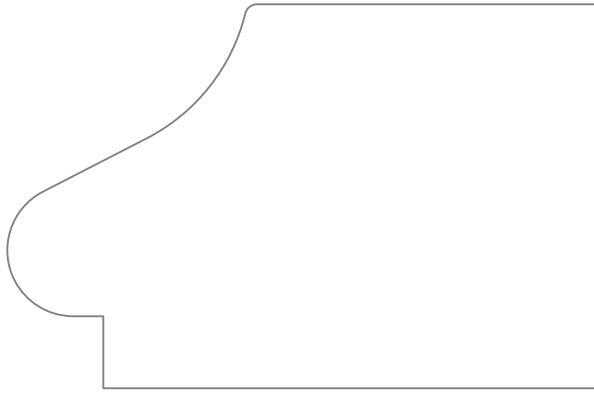

PM-9851

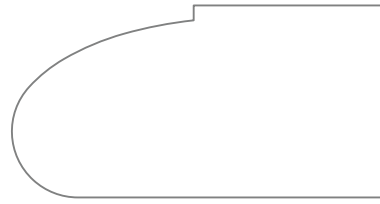

PM-9853

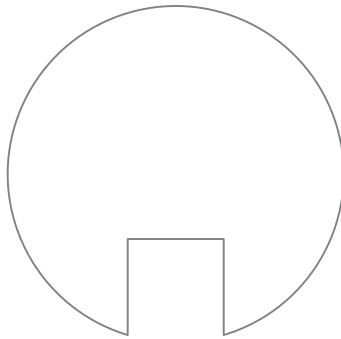

PM-9858

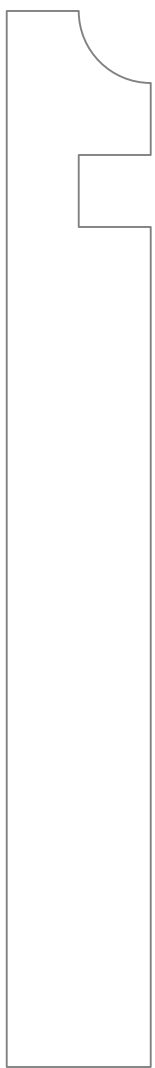

PM-9800



PM-9801

PM-9802



PM-9869

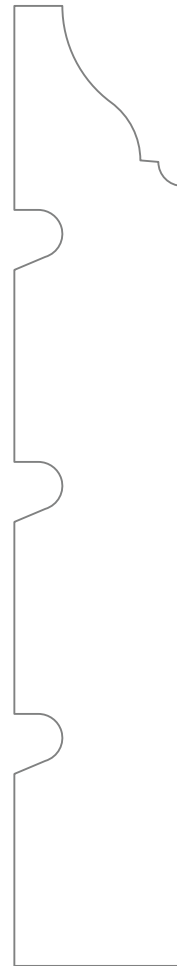

PM-9868

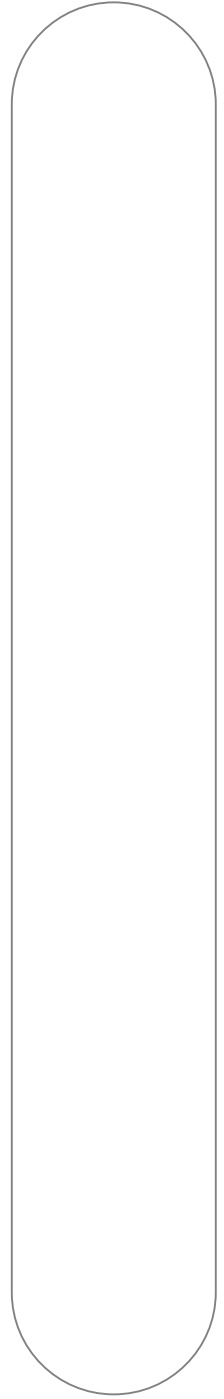

PM-9811

# PIERCE & PIERCE MILLWORK

FULL SCALE

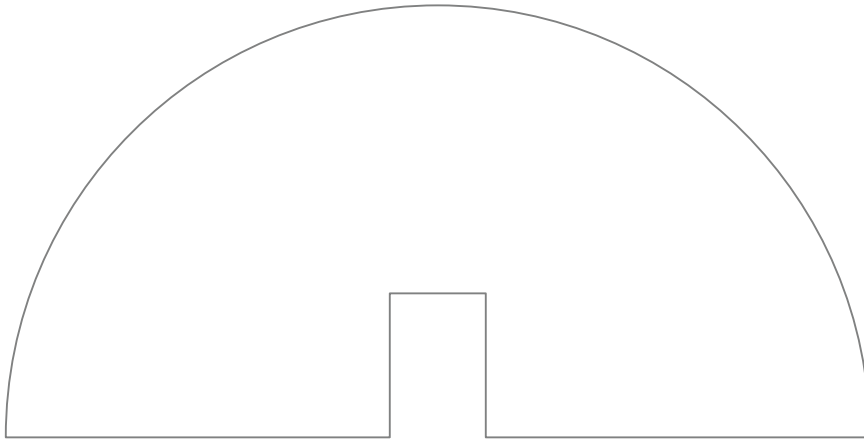

PM-9840

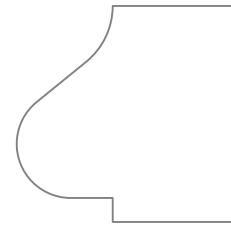

PM-9854

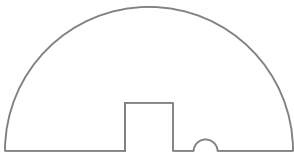

PM-9848

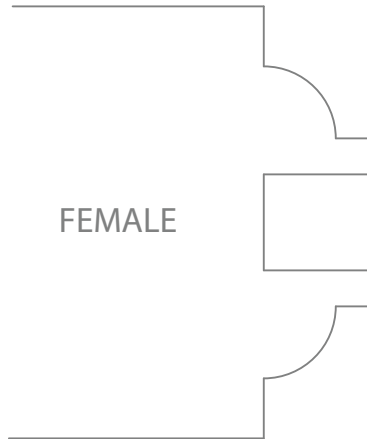

FEMALE

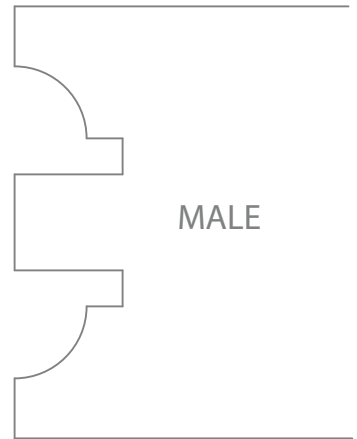

MALE

PM-9849

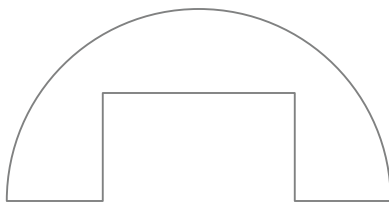

PM-9876

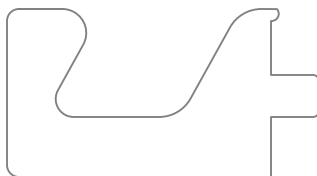

PM-9835

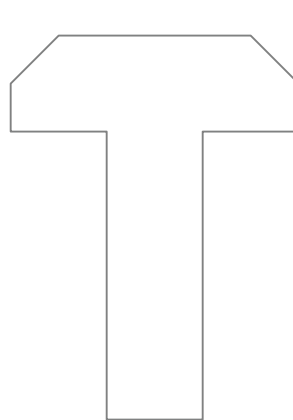

FEMALE

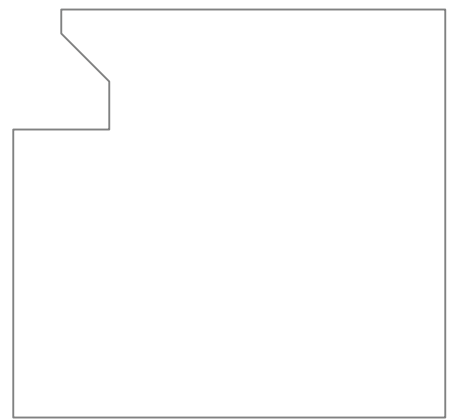

MALE

PM-9816

# PIERCE & PIERCE MILLWORK

FULL SCALE

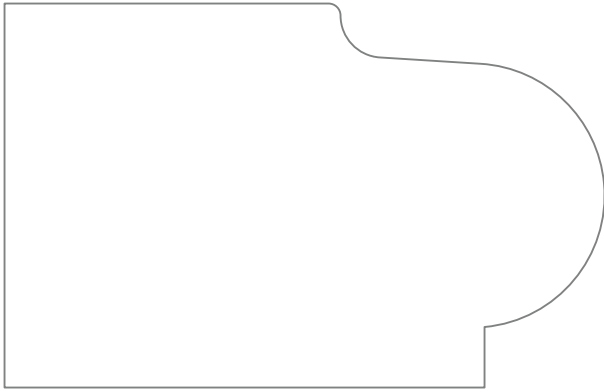

PM-9856

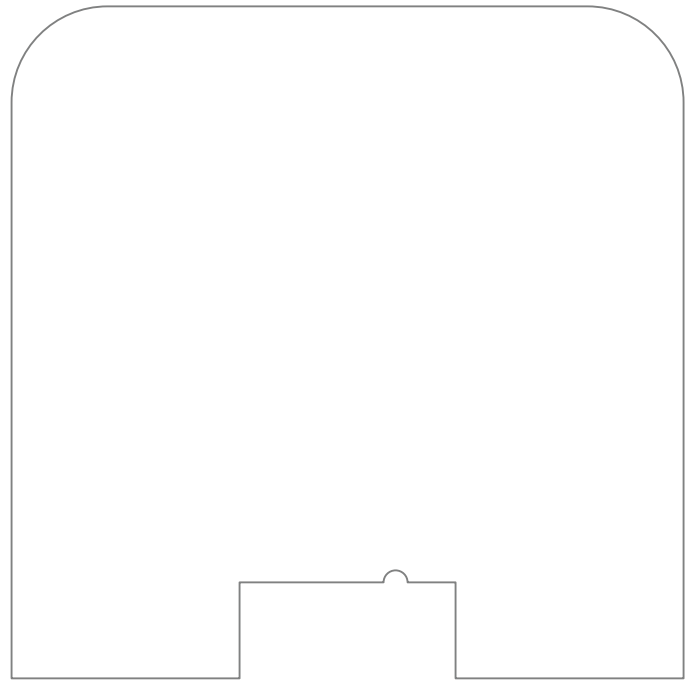

PM-9865

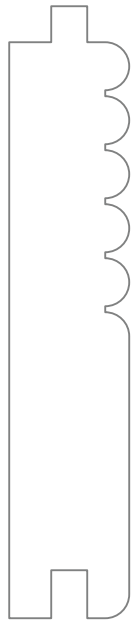

PM-9817

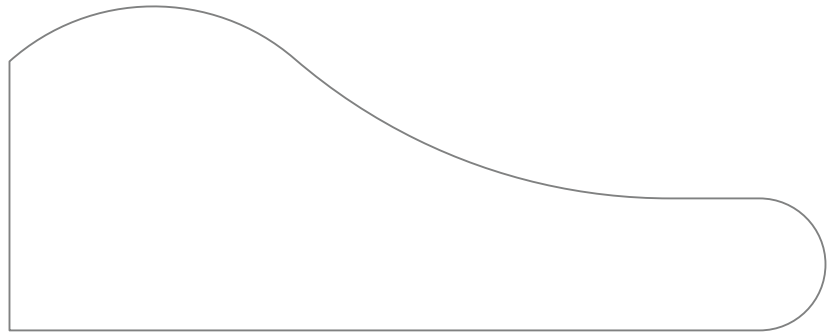

PM-9843



PM-9817M

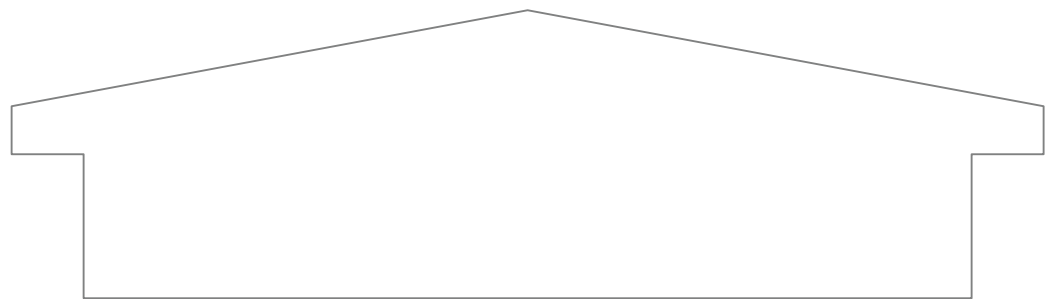

PM-9823

*PIERCE & PIERCE MILLWORK*

*FULL SCALE*

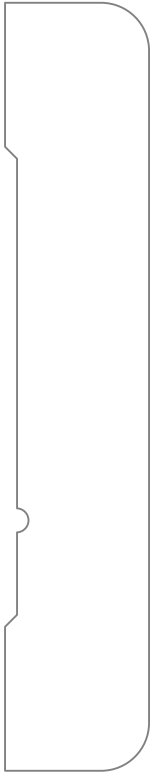

*PM-9900*



*PM-9908*



*PM-9915*



*PM-9921*

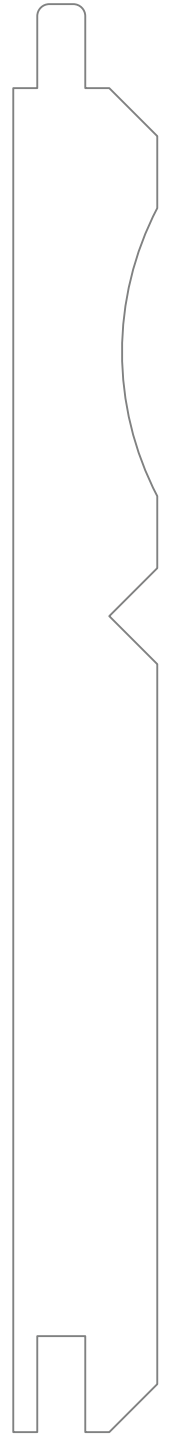

*PM-9958*

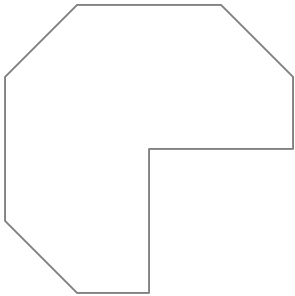

*PM-9966*

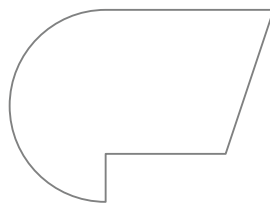

*PM-9928*

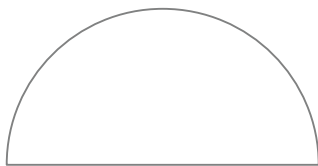

*PM-9906*

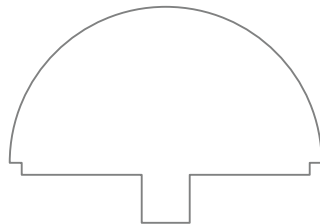

*PM-9912*

# PIERCE & PIERCE MILLWORK

FULL SCALE

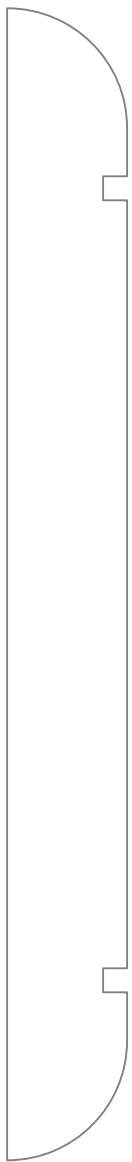

PM-9985

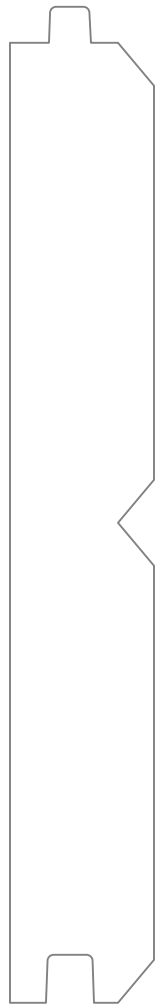

PM-9967

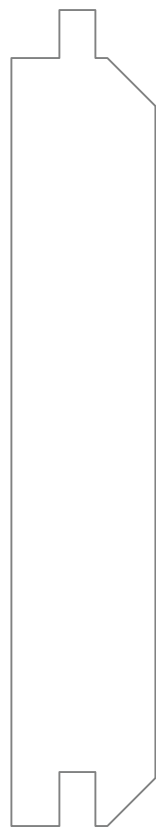

PM-9980

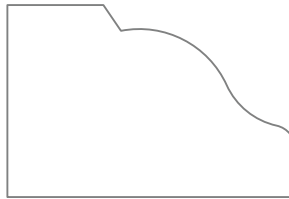

PM-9987

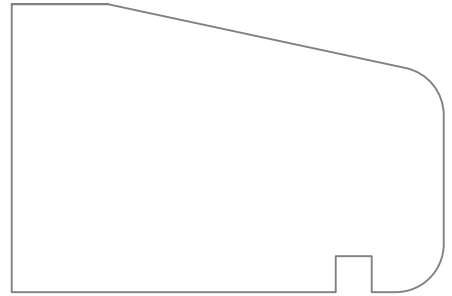

PM-9990

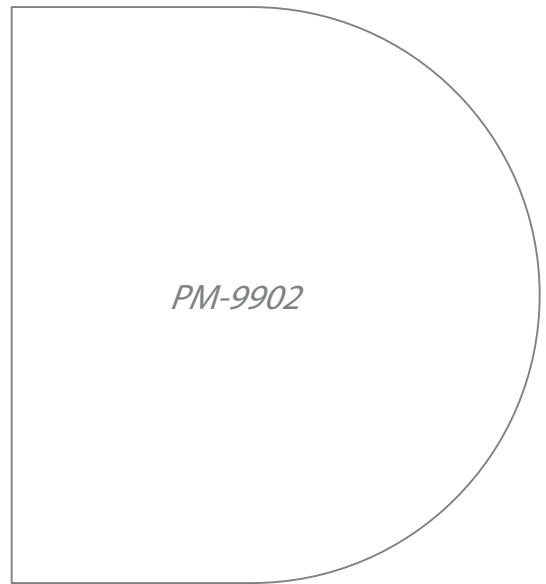

PM-9902

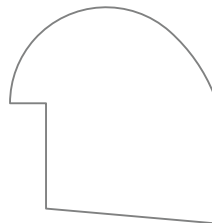

PM-9981

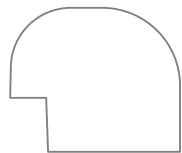

PM-9982

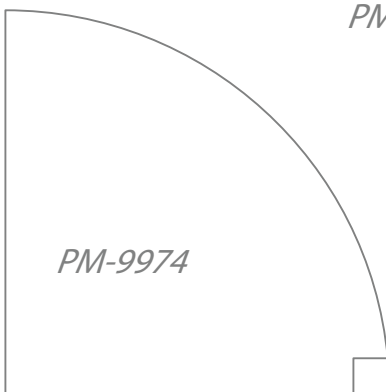

PM-9974

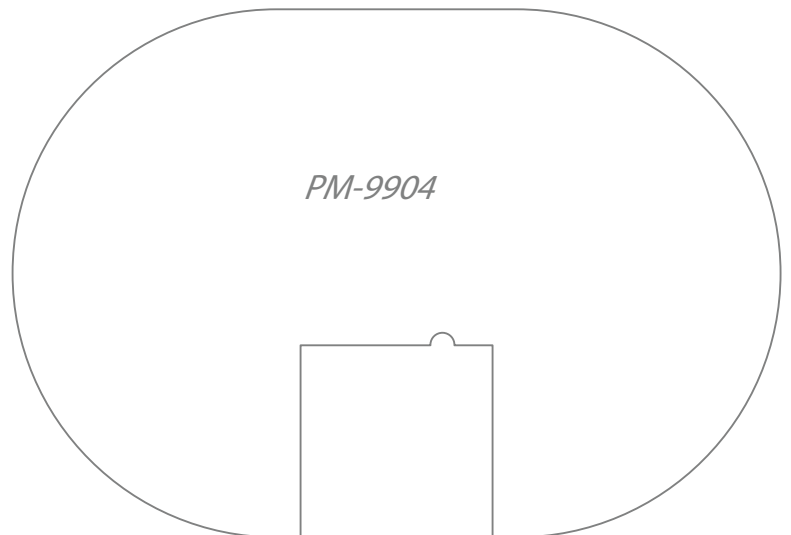

PM-9904

*PIERCE & PIERCE MILLWORK*

*FULL SCALE*

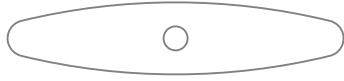

*PM-9911*

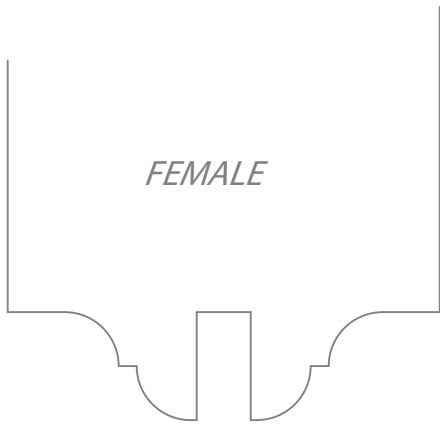

*FEMALE*

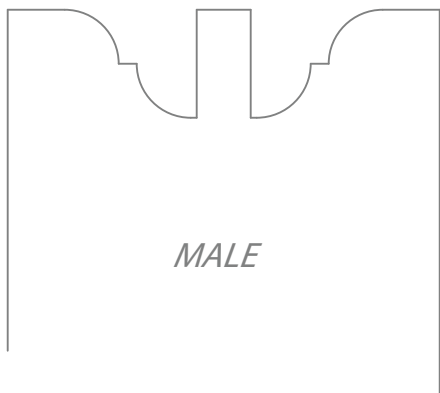

*MALE*

*PM-9913*

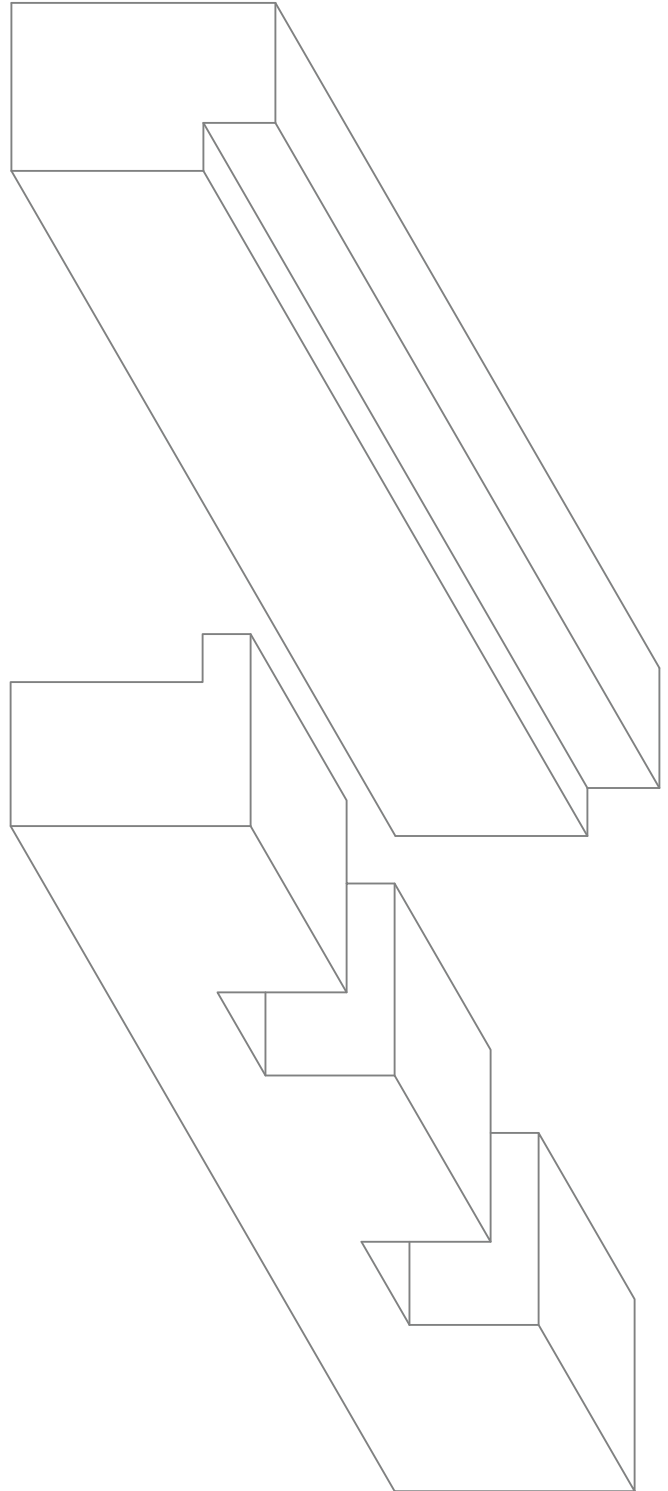

*PM-9916*



# PIERCE & PIERCE MILLWORK

FULL SCALE



PM-9500A



PM-9528A



PM-9530A



PM-9531A



PM-9572A

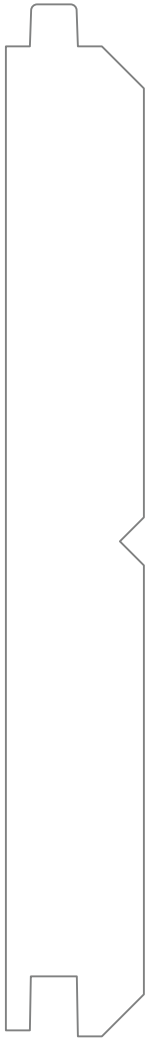

PM-9503A



PM-9517A



PM-9546A



PM-9508A  
USE PM-422

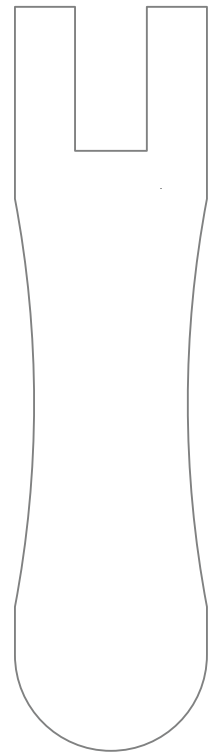

PM-9506A

*PIERCE & PIERCE MILLWORK*

*FULL SCALE*

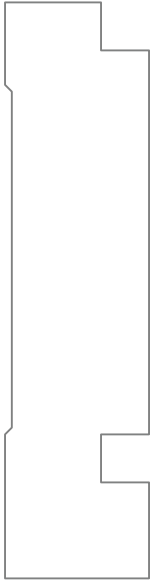

*PM-9520A*

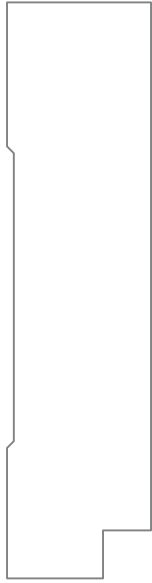

*PM-9523A*

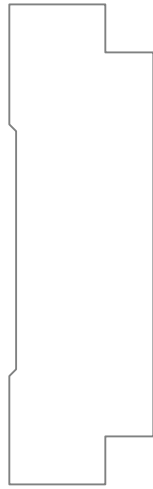

*PM-9521A*



*PM-9540A*



*PM-9524A*



*PM-9594A*

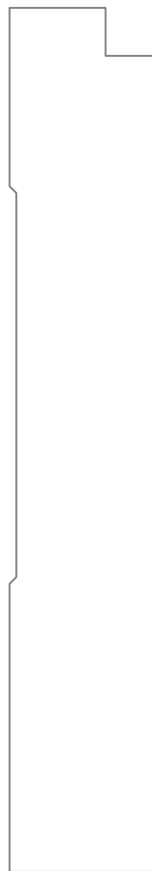

*PM-9526A*



*PM-9525A*



*PM-9507A*

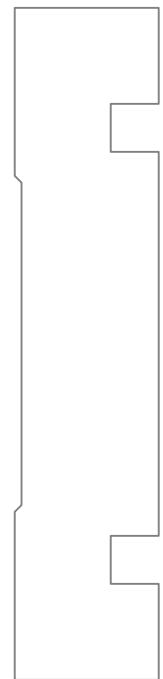

*PM-9522A*

*PIERCE & PIERCE MILLWORK*

*FULL SCALE*

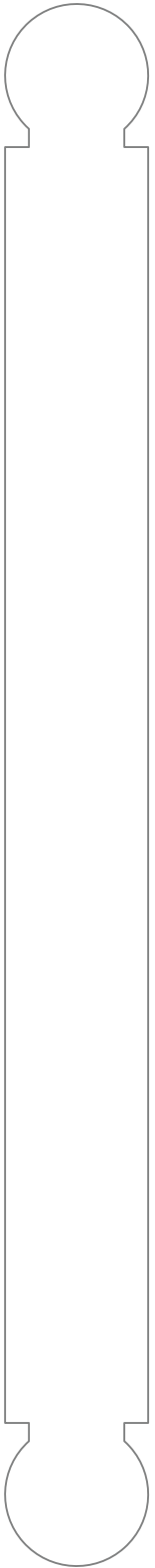

*PM-9582A*



*PM-9570A*



*PM-9574A*

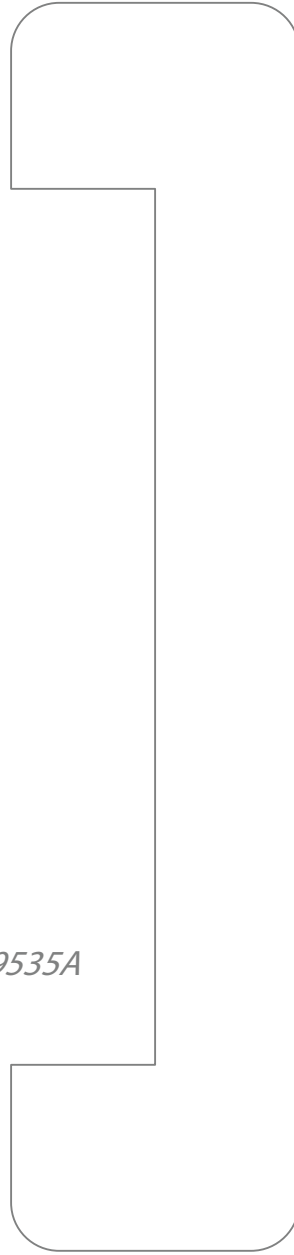

*PM-9535A*

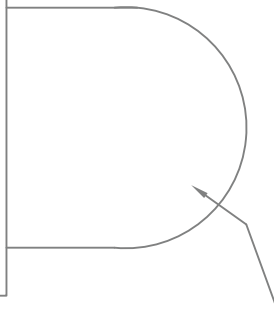

*PM-9573A*

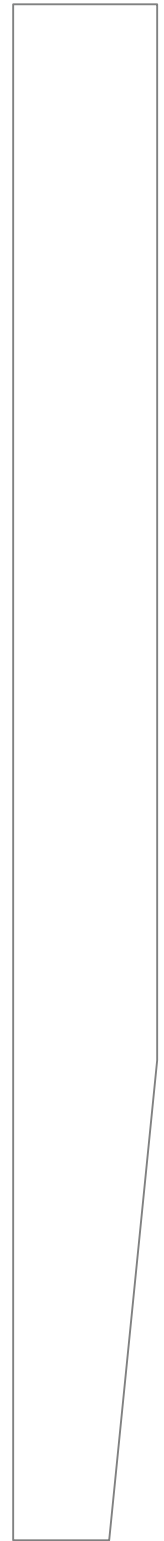

*PM-9549A*

*PIERCE & PIERCE MILLWORK*

*FULL SCALE*

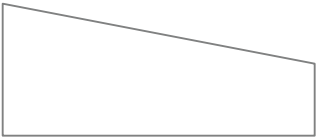

*PM-9579A*

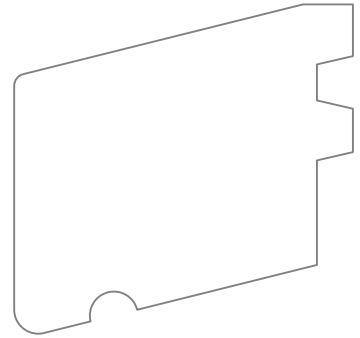

*PM-9547A*

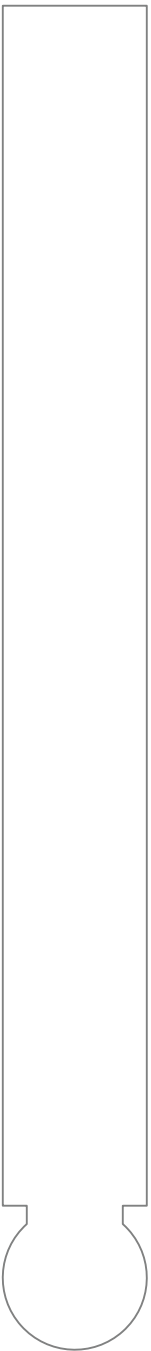

*PM-9583A*



*PM-9596A*



*PM-9599A*

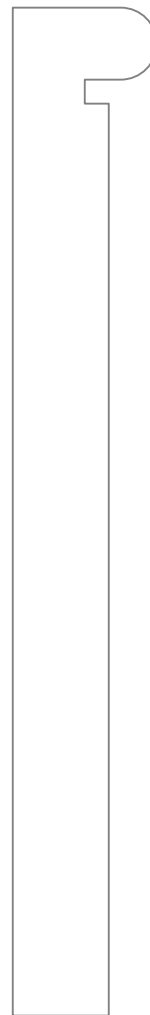

*PM-9588A*

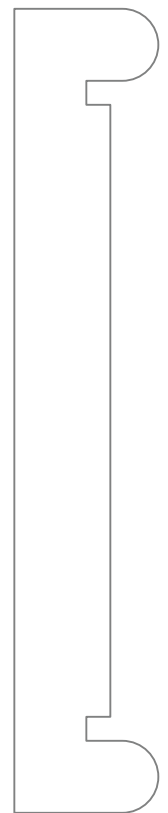

*PM-9587A*

# PIERCE & PIERCE MILLWORK

FULL SCALE

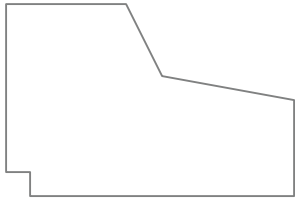

PM-9509A

USE PM-9780

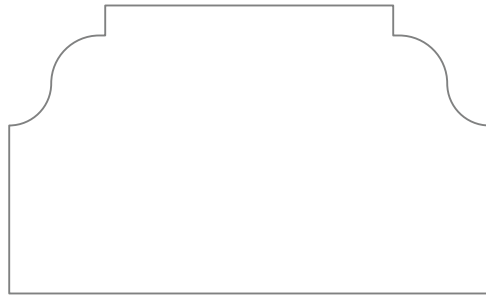

PM-9575A

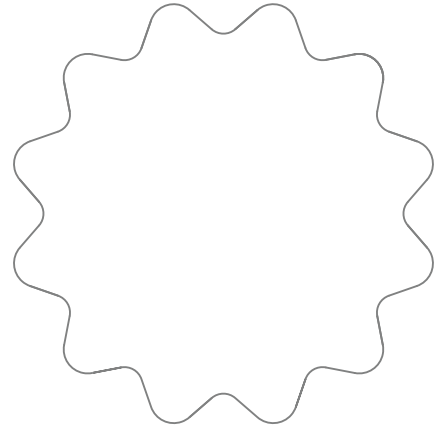

PM-9541A

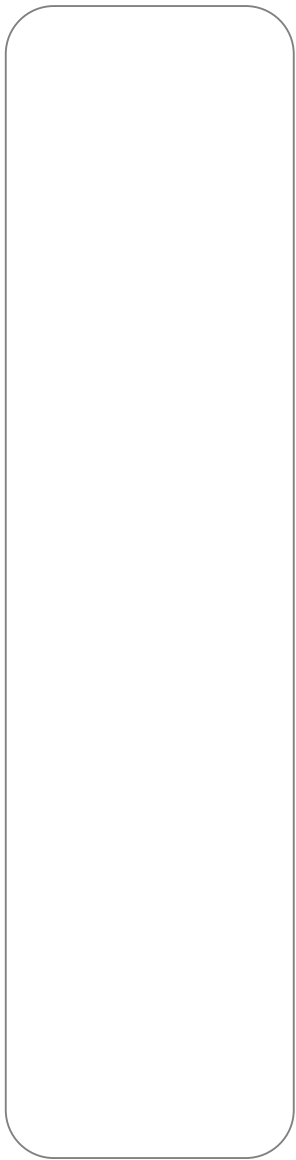

PM-9527A

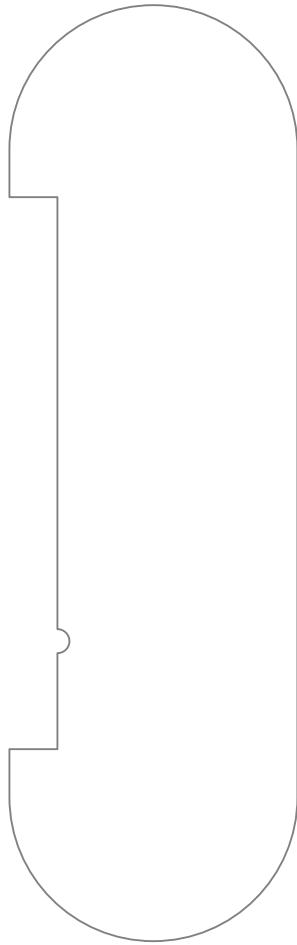

PM-9529A



PM-9578A

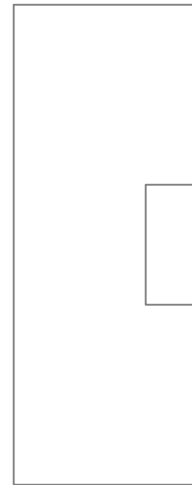

PM-9562A

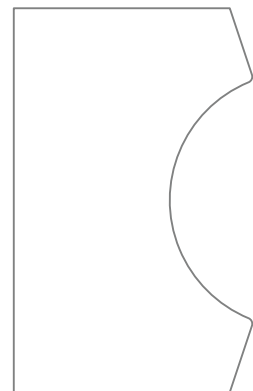

PM-9591A

# PIERCE & PIERCE MILLWORK

FULL SCALE

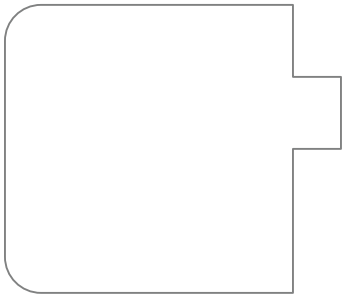

PM-9504A

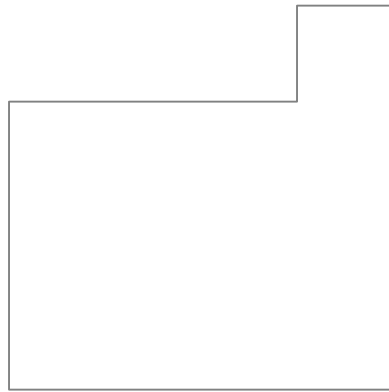

PM-9512A

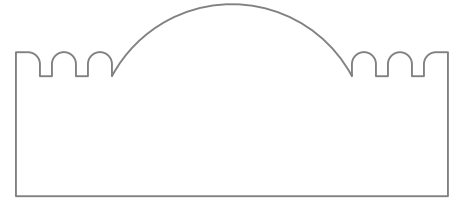

PM-9501A



PM-9589A

USE PM-9874

KNIVES

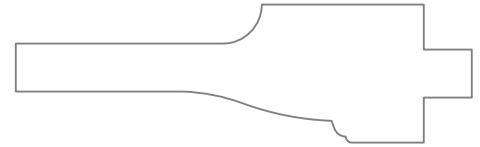

PM-9561A

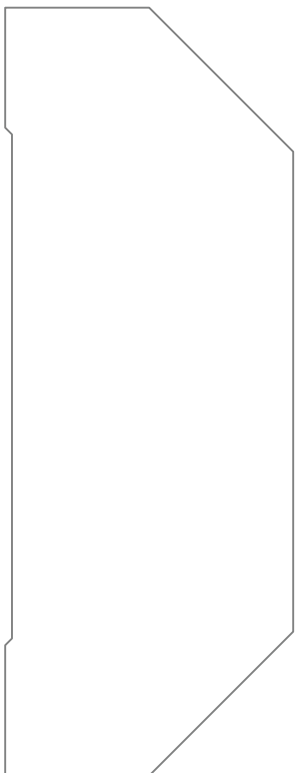

PM-9559A

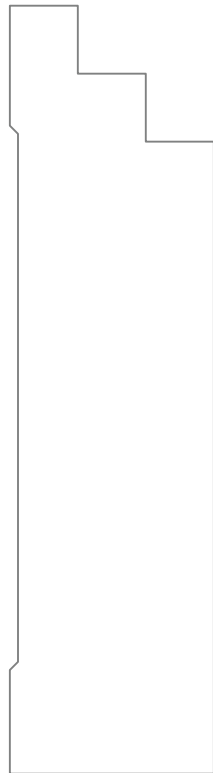

PM-9502A



PM-9586A

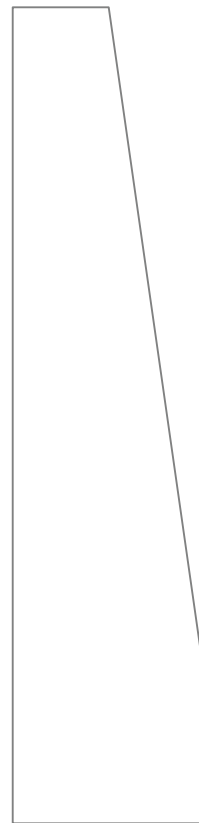

PM-9563A

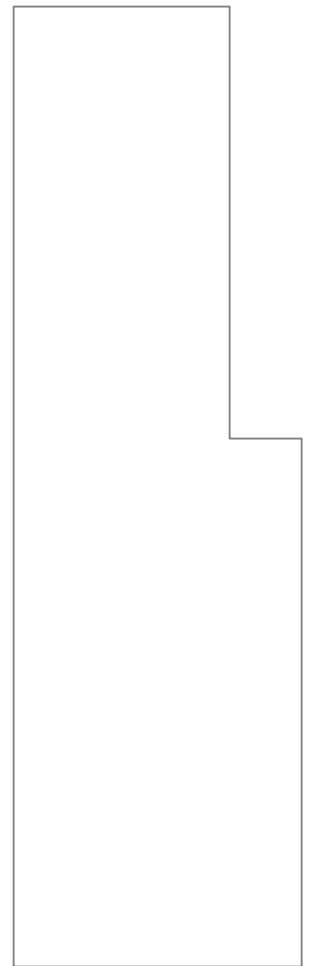

PM-9597A

*PIERCE & PIERCE MILLWORK*

*FULL SCALE*

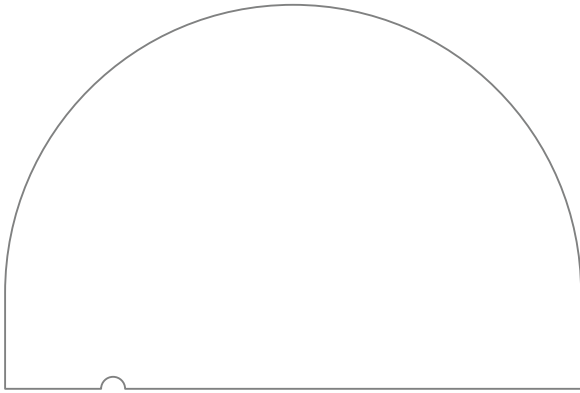

*PM-9505A*

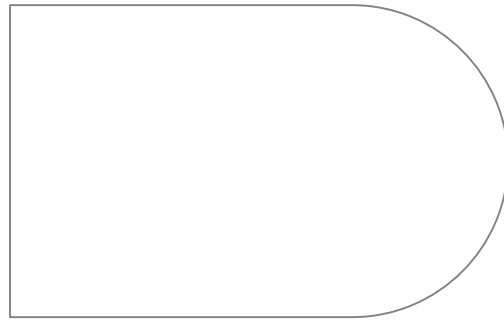

*PM-9516A*

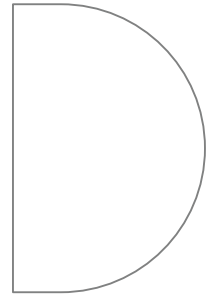

*PM-9542A*

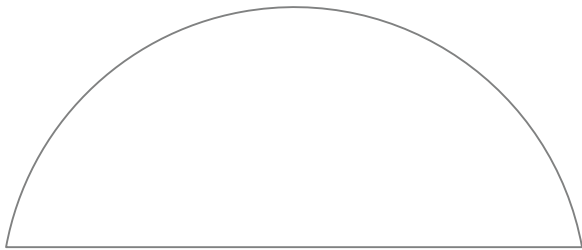

*PM-9585A*

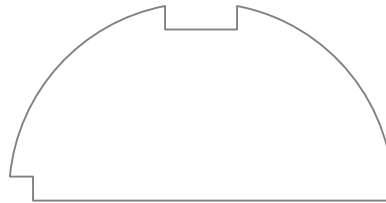

*PM-9518A*

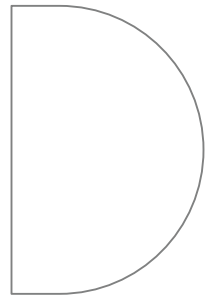

*PM-9568A*

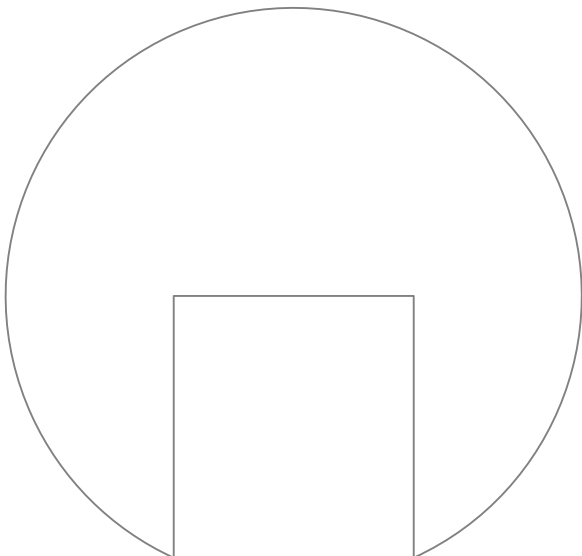

*PM-9598A*

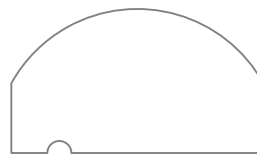

*PM-9551A*

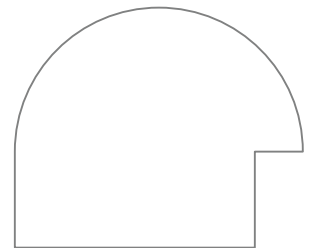

*PM-9543A*

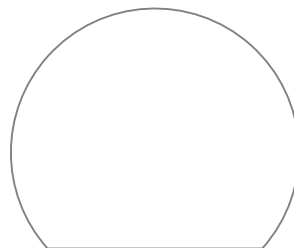

*PM-9556A*

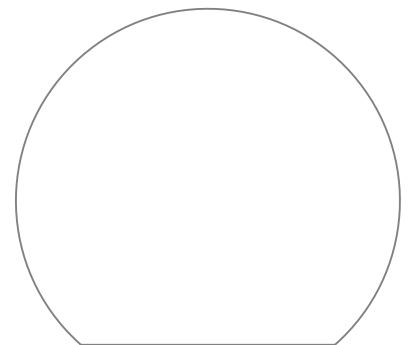

*PM-9544A*

*TOP PART OF  
PM-1269*

# PIERCE & PIERCE MILLWORK

FULL SCALE



PM-9533A



PM-9534A



PM-9555A



PM-9539A



PM-9538A



PM-9553A

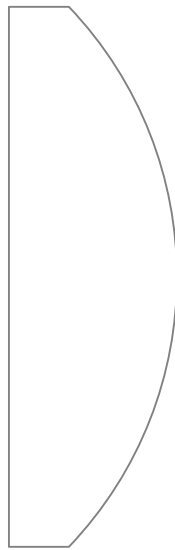

PM-9564A

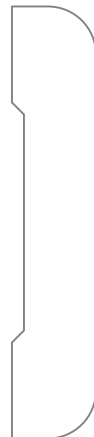

PM-9554A



PM-9545A



PM-9567A



PM-9571A

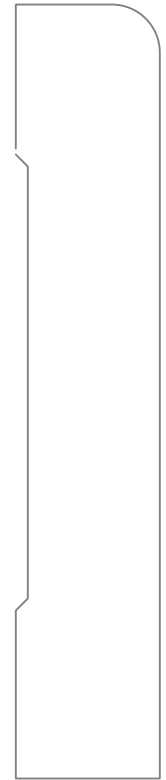

PM-9552A

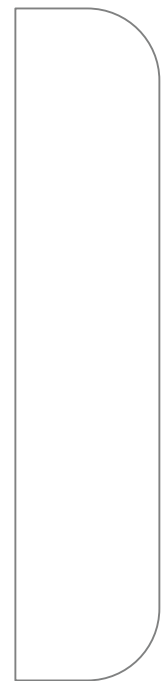

PM-9569A



# PIERCE & PIERCE MILLWORK

FULL SCALE

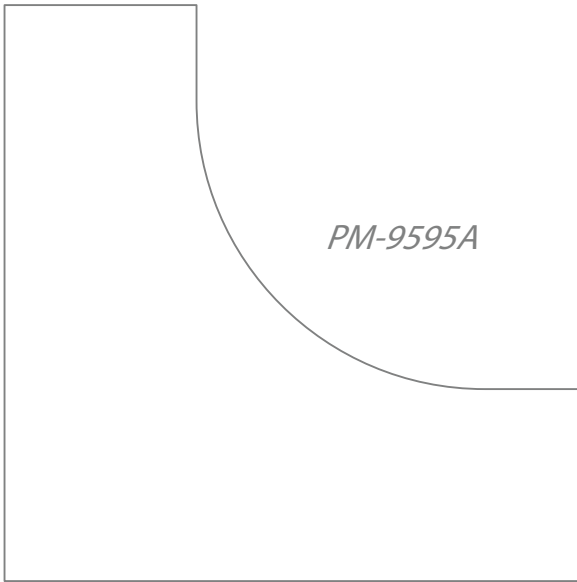

*PM-9595A*



*PM-9577A*

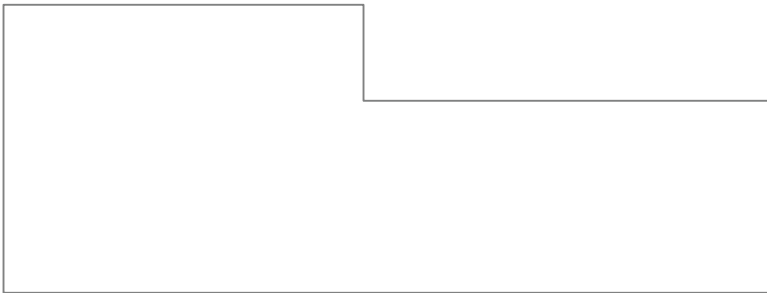

*PM-9558A*

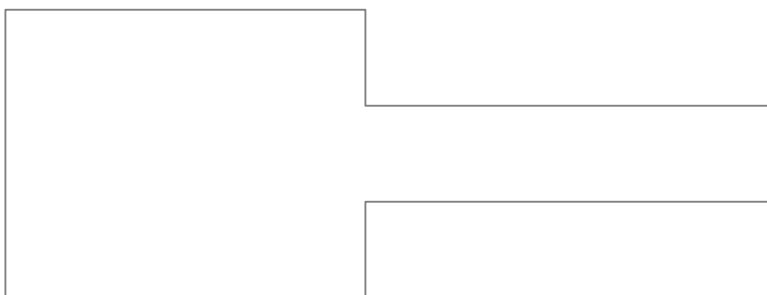

*PM-9557A*

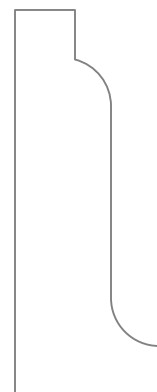

*PM-9593A*

*USE PM-7505*

*KNIVES*

# PIERCE & PIERCE MILLWORK

FULL SCALE

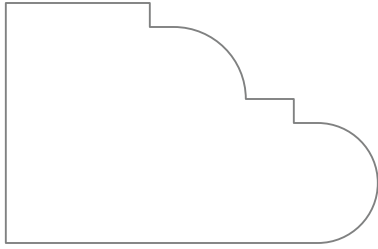

PM-9611A

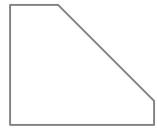

PM-9621A



PM-9613A

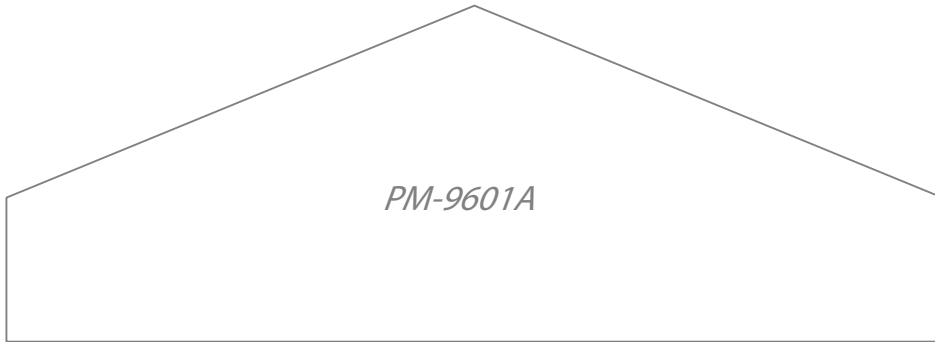

PM-9601A

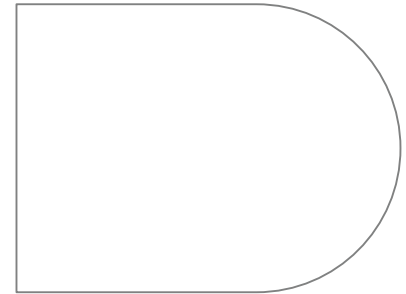

PM-9612A

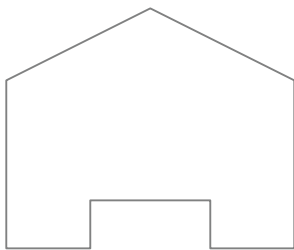

PM-9603A

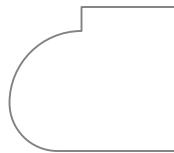

PM-9687A



PM-9605A



PM-9604A



PM-9608A



PM-9609A

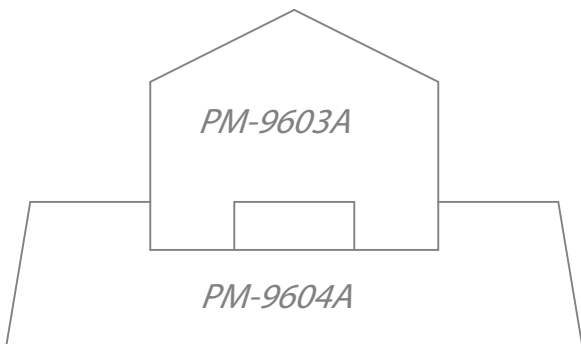

PM-9603A

PM-9604A

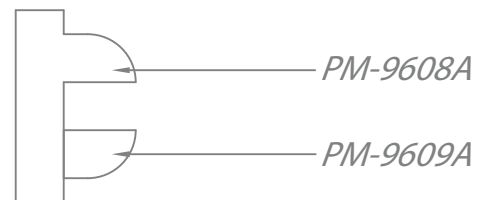

PM-9608A

PM-9609A

# PIERCE & PIERCE MILLWORK

FULL SCALE

PM-9626A

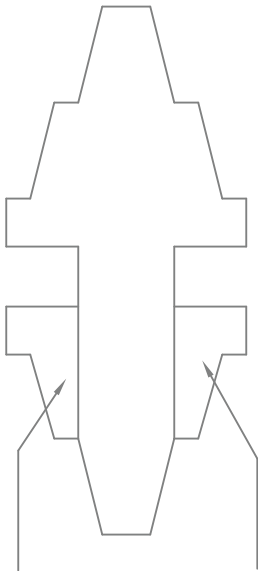

PM-9627A

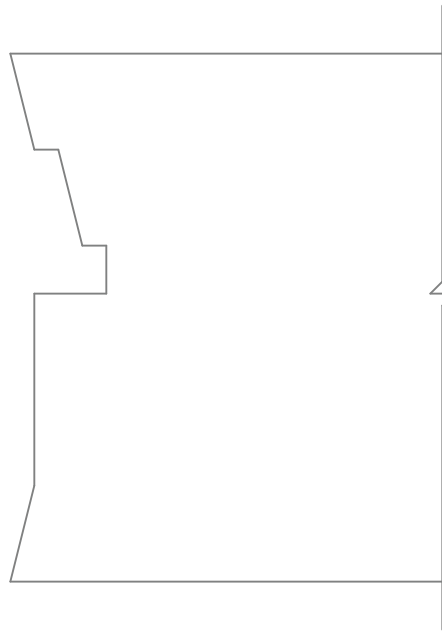

PM-9685A

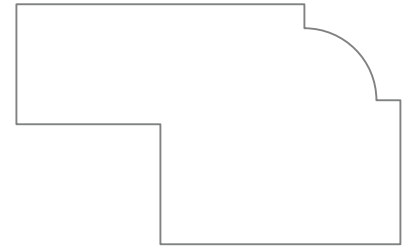

PM-9640A



PM-9696A

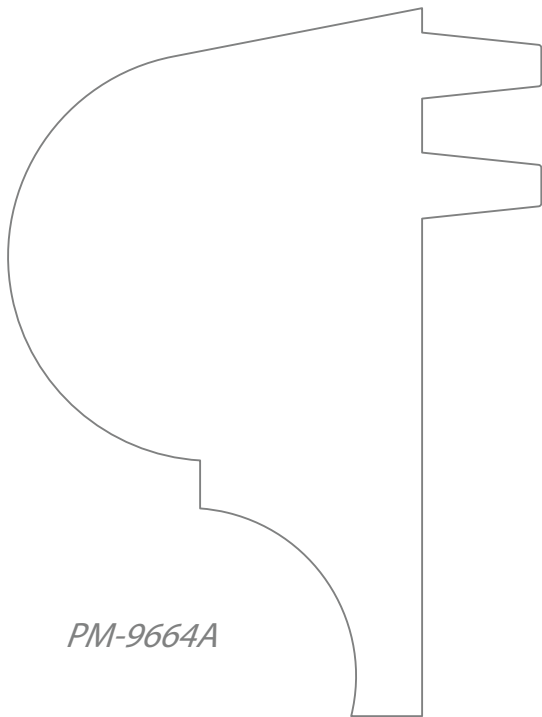

PM-9664A

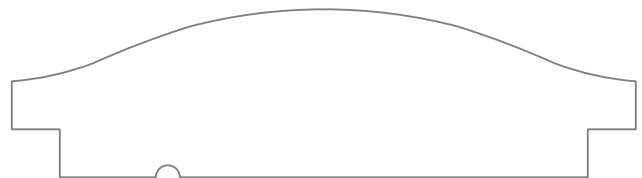

PM-9646A

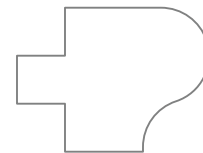

PM-9636A

USE PM-411

STOOL

*PIERCE & PIERCE MILLWORK*

*FULL SCALE*

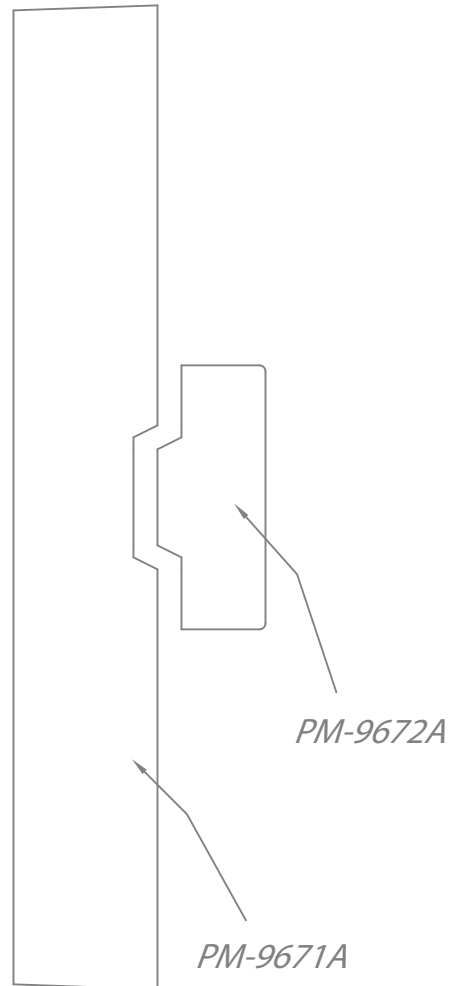
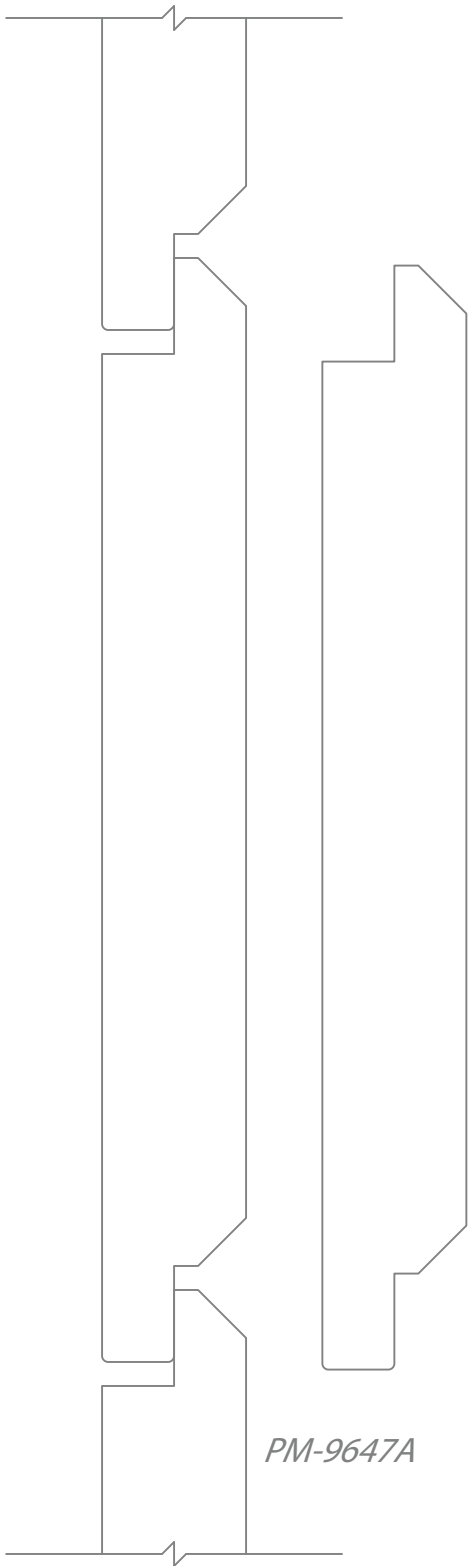

*PM-9670A*

*USE PM-9764*

*KNIVES*

# PIERCE & PIERCE MILLWORK

FULL SCALE

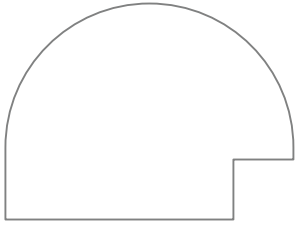

PM-9704A

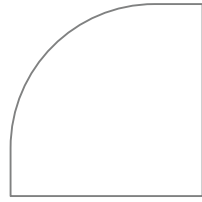

PM-9739A

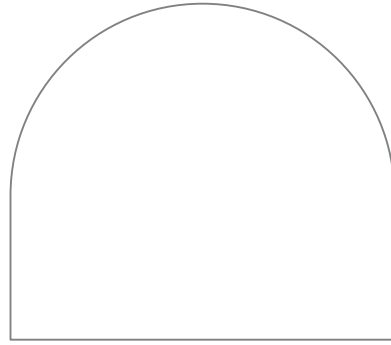

PM-9744A

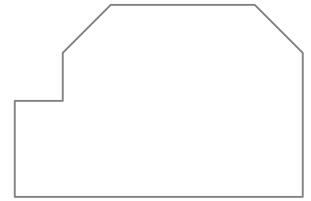

PM-9745A

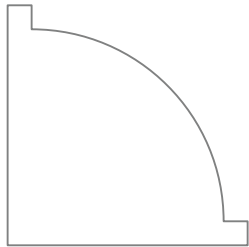

PM-9793A

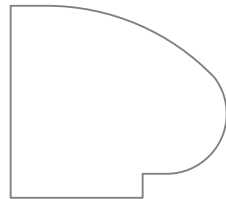

PM-9786A

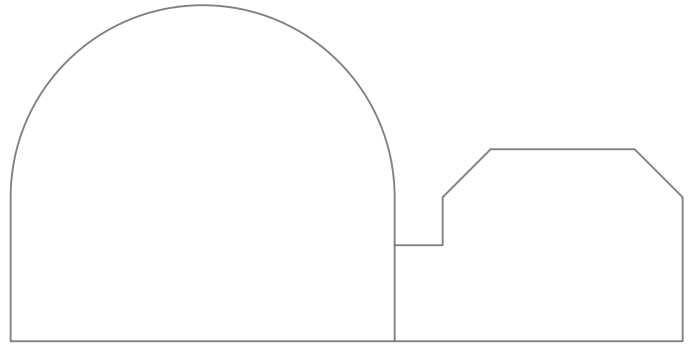

PM-9774A



PM-9780A

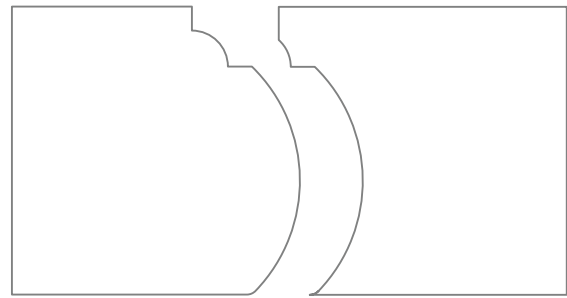

PM-9735A

PM-9736A



PM-9785A

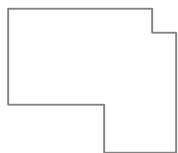
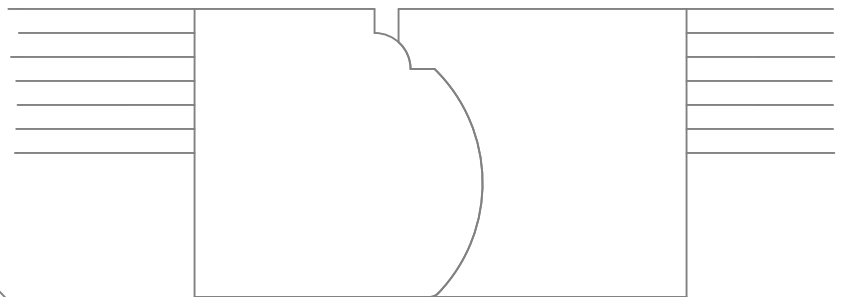

PM-9724A

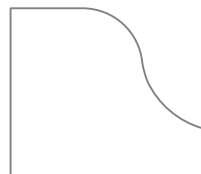

PM-9784A

*PIERCE & PIERCE MILLWORK*

*FULL SCALE*

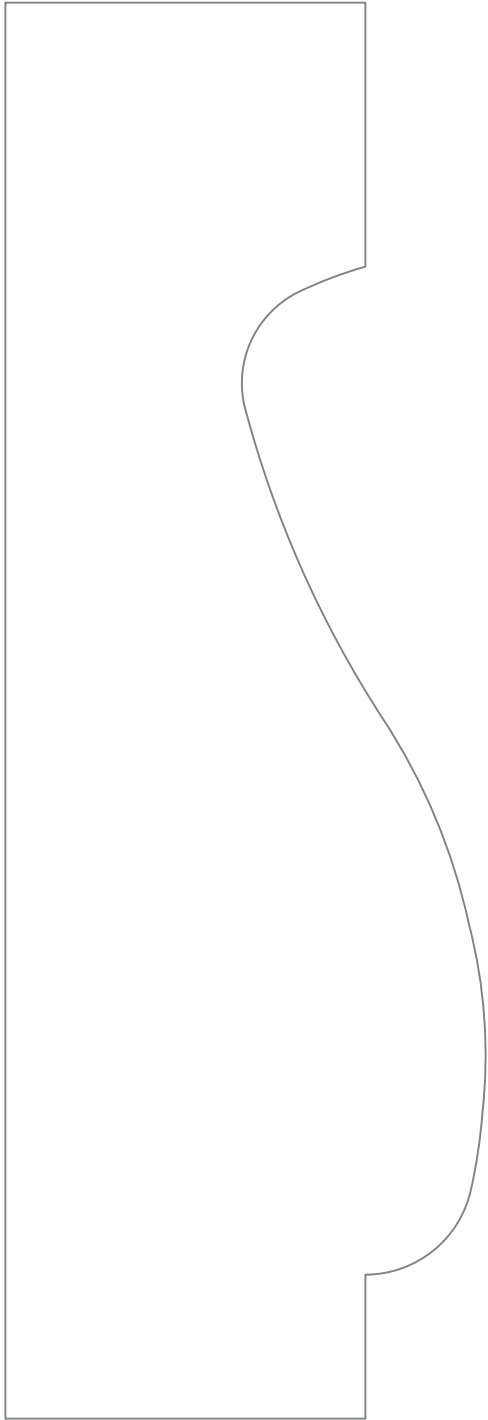

*PM-9709A*

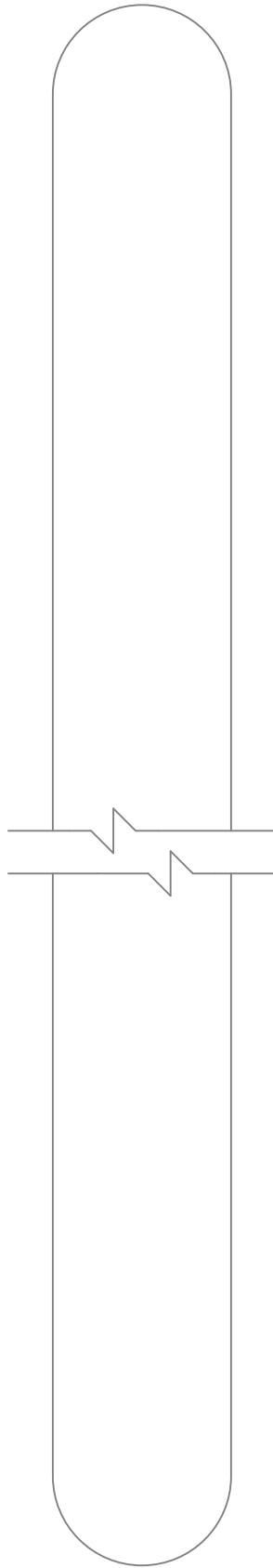

*PM-9779A*

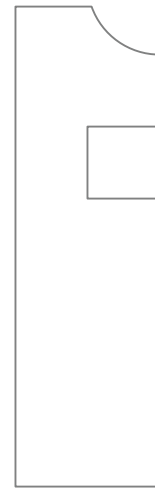

*PM-9717A*



*PM-9713A*

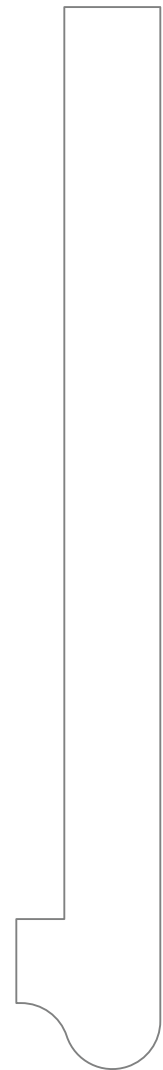

*PM-9741A*

# PIERCE & PIERCE MILLWORK

FULL SCALE

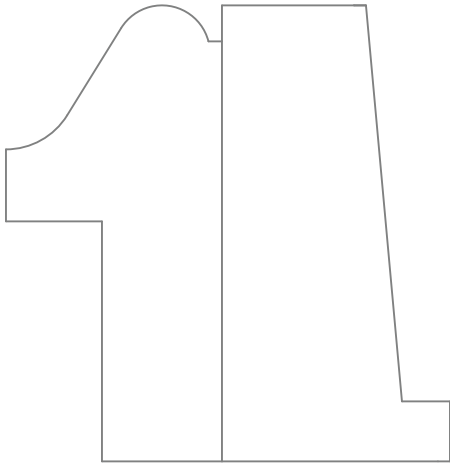

PM-9711A

PM-9710A

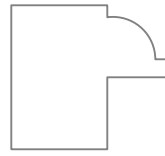

PM-9714A

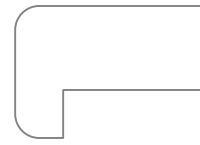

PM-9732A

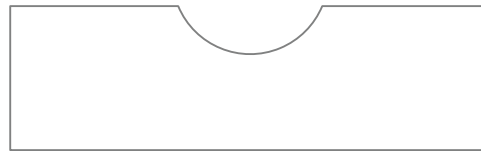

PM-9734A



PM-9783A

USE PM-4505

KNIVES

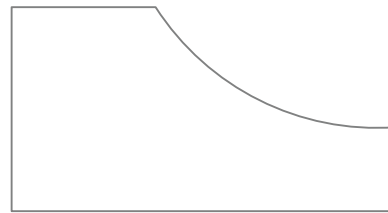

PM-9798A

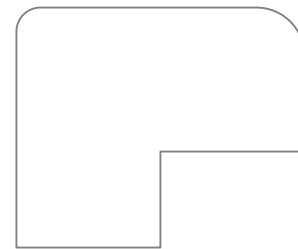

PM-9797A



PM-9777A

USE PM-618 KNIVES

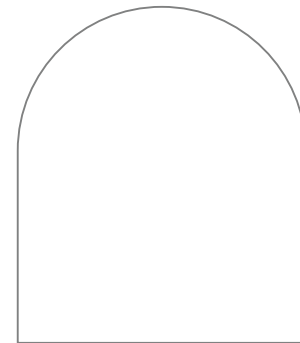

PM-9703A

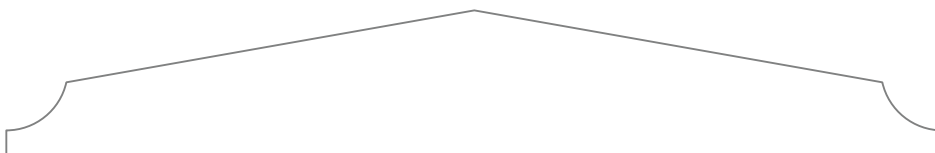

PM-9790A

USE PM-8025 KNIVES

# PIERCE & PIERCE MILLWORK

FULL SCALE

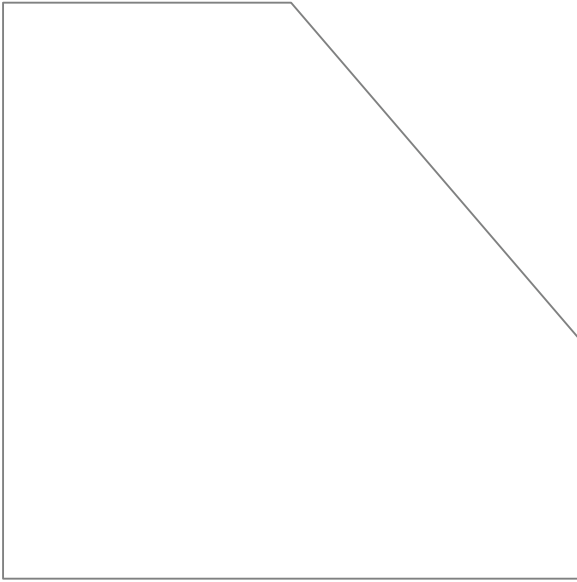

PM-9796A



PM-9716A

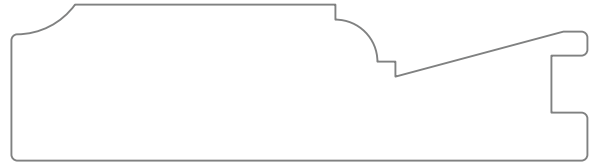

PM-9723A

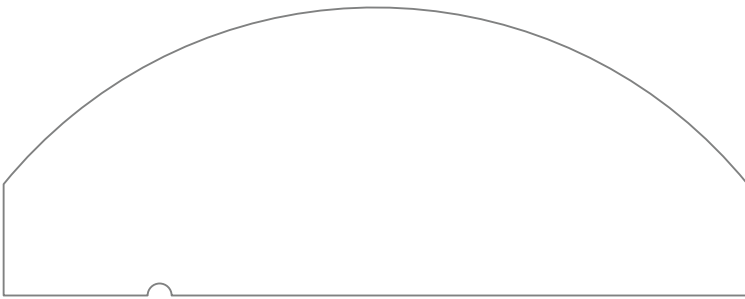

PM-9748A



PM-9773A



PM-9776A



PM-9763A

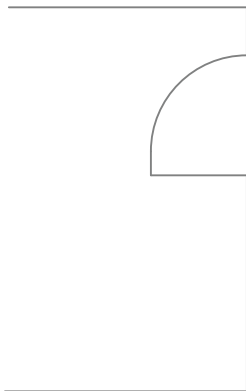

PROFILE

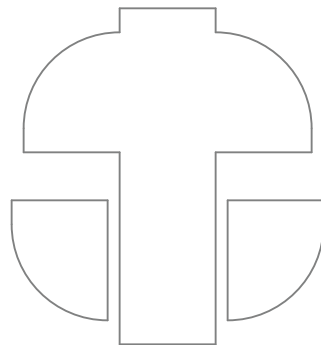

MUTTING

PM-9722A



COPE



PM-9762A



# PIERCE & PIERCE MILLWORK

FULL SCALE

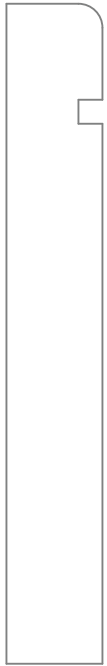

PM-9726A



PM-9750A

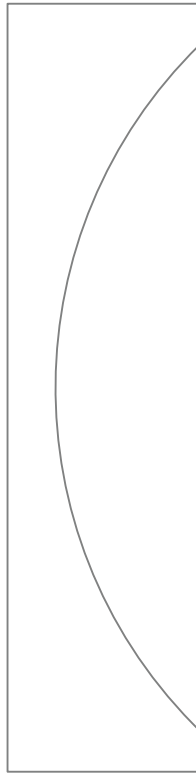

PM-9749A



PM-9764A

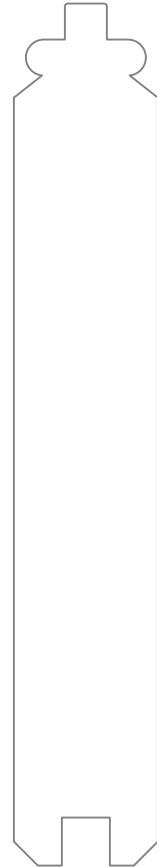

PM-9770A

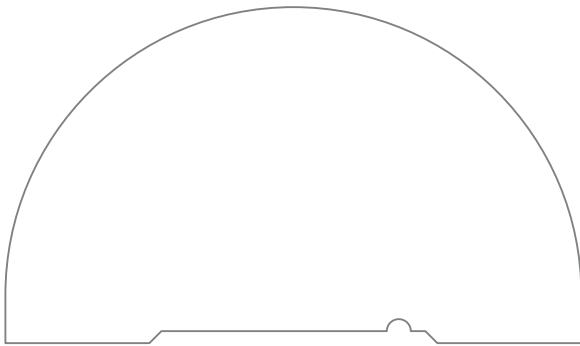

PM-9742A

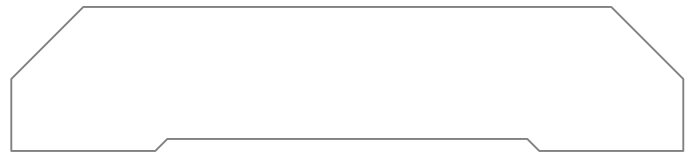

PM-9751A

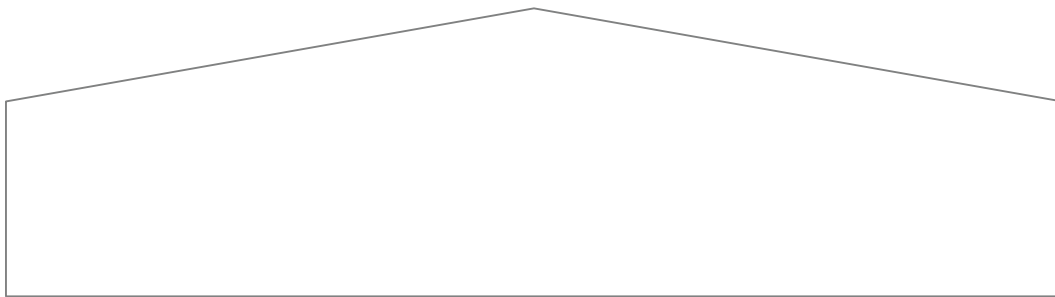

PM-9795A

USE PM-8025 KNIVES

*PIERCE & PIERCE MILLWORK*

*FULL SCALE*

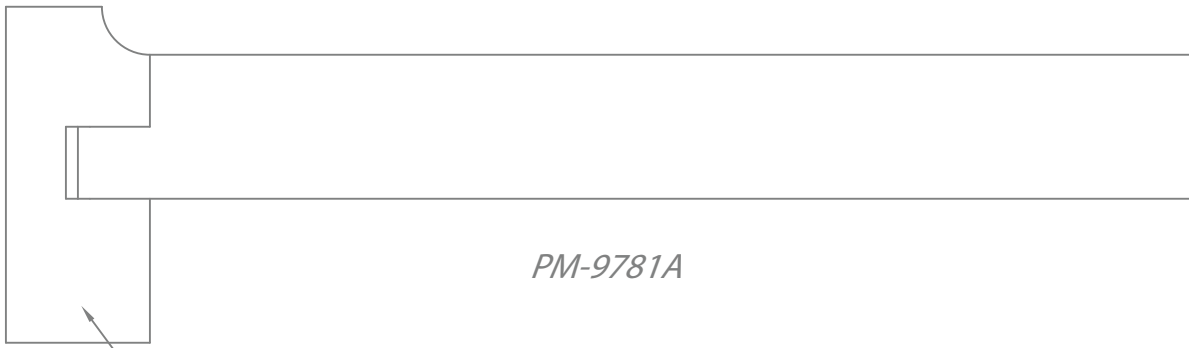

*PM-9781A*



*PM-9782A*

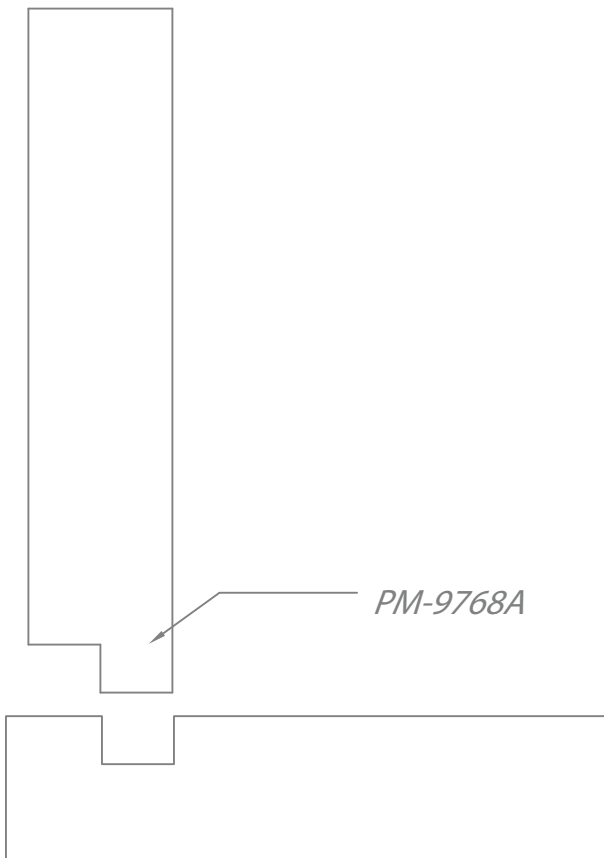

*PM-9768A*

*PM-9769A*

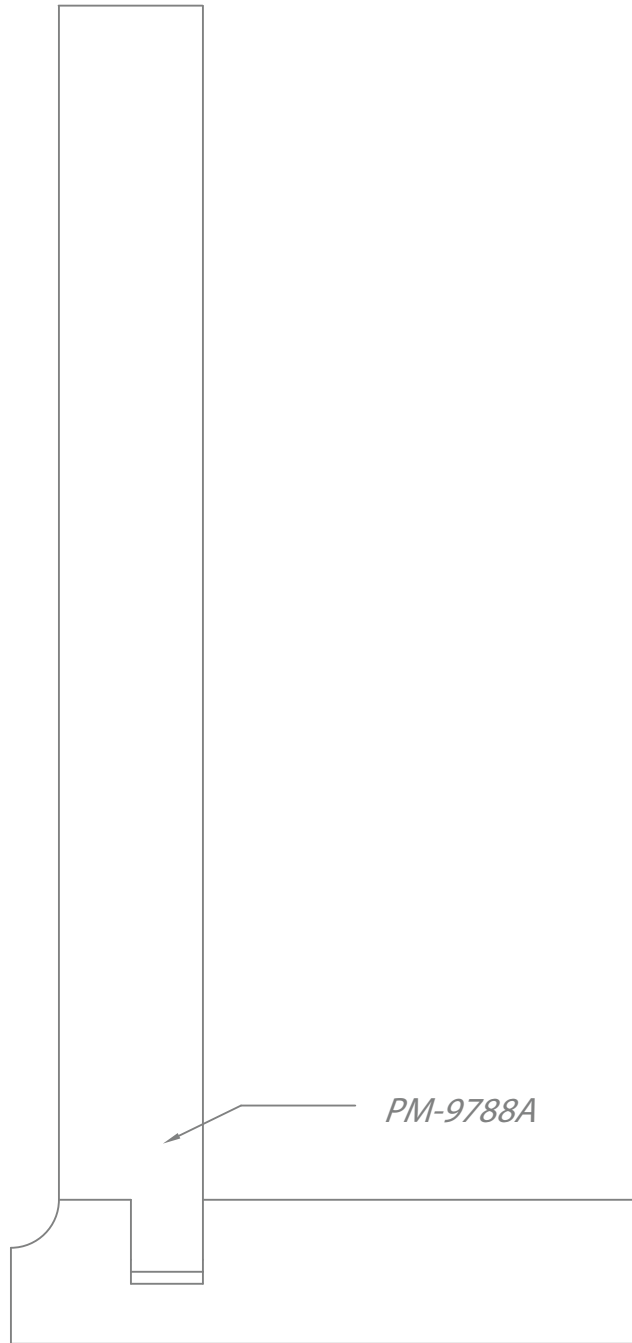

*PM-9788A*

*PM-9787A*

# PIERCE & PIERCE MILLWORK

FULL SCALE

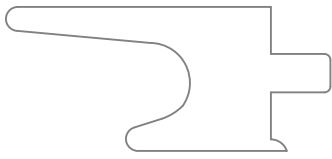

PM-9808A

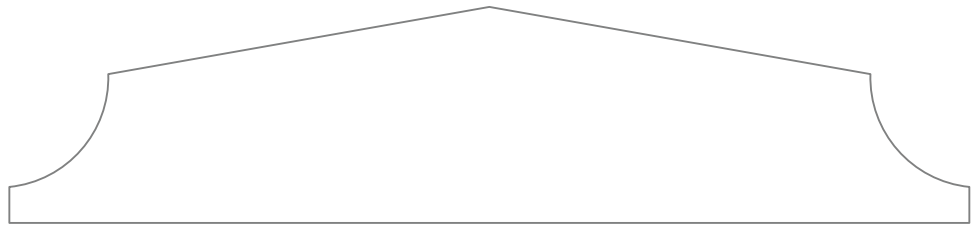

PM-9816A

USE PM-8025A KNIVES



PM-9872A

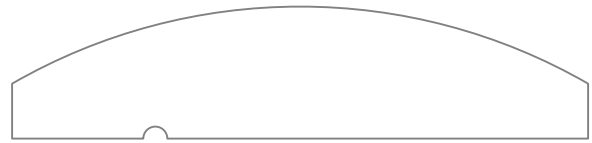

PM-9820A

USE PM-989 KNIVES



PM-9867A

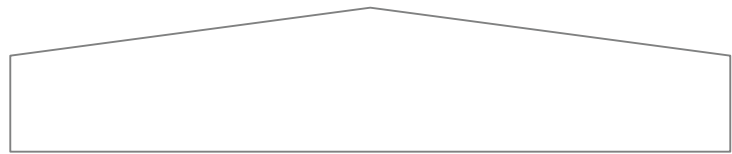

PM-9843A

USE PM-8027

TOP KNIVES



PM-9868A



PM-9851A

PM-9852A

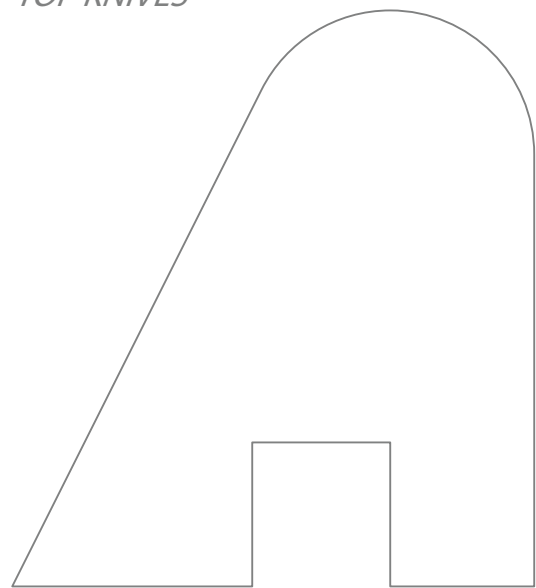

PM-9807A

# PIERCE & PIERCE MILLWORK

FULL SCALE

PM-9823A

USE PM-9770A

KNIVES

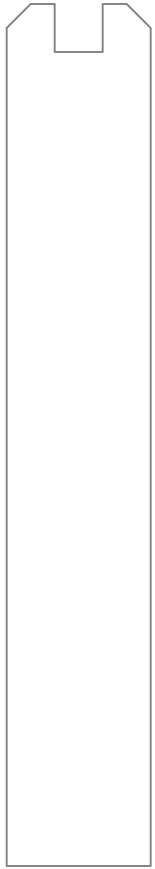

PM-9866A

USE PM-987

KNIVES



PM-9847A

PM-9845A

USE PM-445

KNIVES

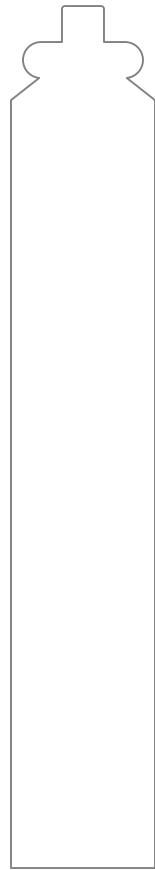
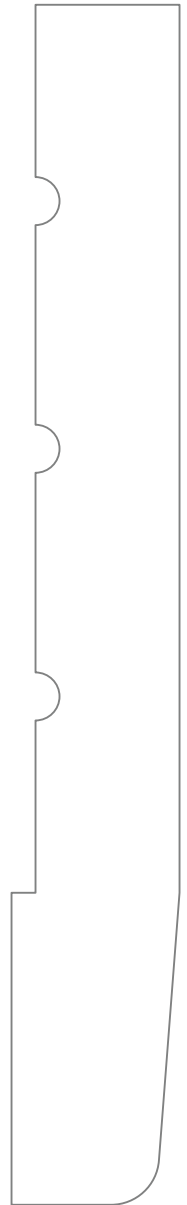

PM-9822A

USE PM-9770A

KNIVES



PM-9801A



PM-9844A

USE PM-445

KNIVES

PM-9812A

# PIERCE & PIERCE MILLWORK

FULL SCALE

PM-9853A



PM-9863A

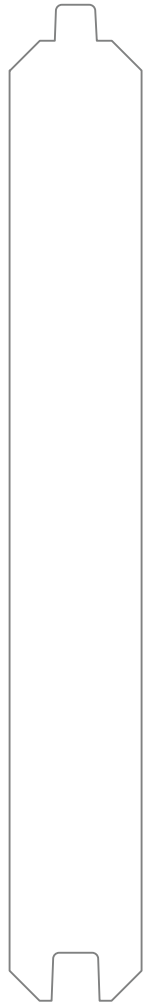

PM-9850A



PM-9849A



PM-9848A



PM-9835A

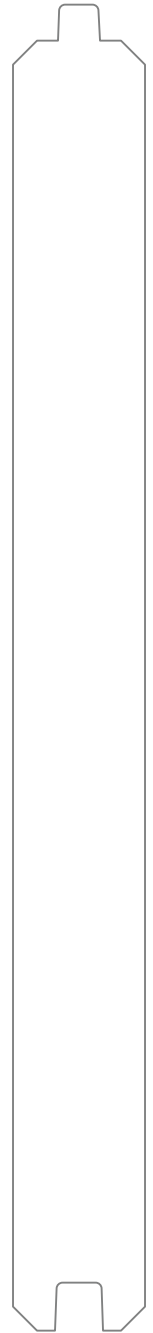

USE PM-445

SIDE KNIVES



PM-9885A



PM-9860A

*PIERCE & PIERCE MILLWORK*

*FULL SCALE*

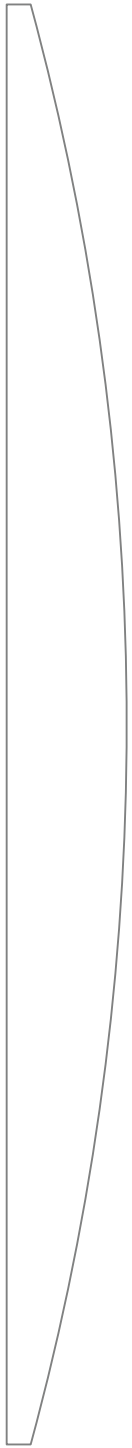

*PM-9887A*



*PM-9858A*



*PM-9871A*



*PM-9865A*

*USE PM-1680  
KNIVES*

*PIERCE & PIERCE MILLWORK*

*FULL SCALE*

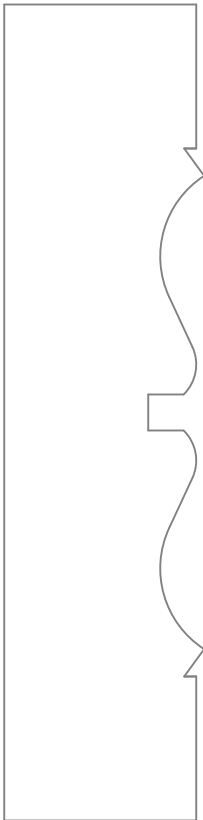

*PM-9547B*



*PM-9668B*

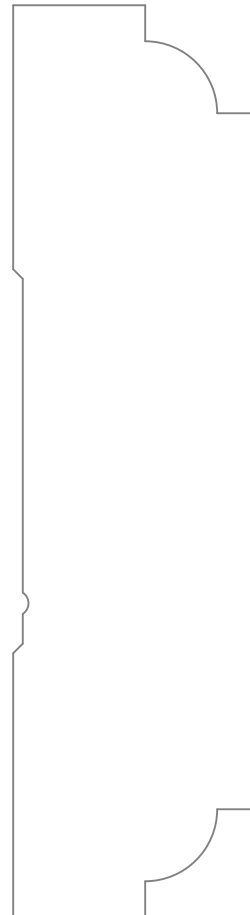

*PM-9675B*